

R&S[®] FSP

Spectrum Analyzer

Quick Start Guide



1164.4556.62 – 04

The Quick Start Guide describes the following R&S®FSP models and options:

- R&S FSP3 (1164.4391K03)
- R&S FSP7 (1164.4391K07)
- R&S FSP13 (1164.4391K13)
- R&S FSP30 (1164.4391K30)
- R&S FSP30 (1164.4391K39)
- R&S FSP31 (1164.4391K31)
- R&S FSP40 (1164.4391K40)

The firmware of the instrument makes use of several valuable open source software packages. The most important of them are listed below, together with their corresponding open source license. The verbatim license texts are provided on the user documentation CD-ROM (included in delivery).

Package	Link	License
Xitami	http://www.xitami.com	2.5b6
PHP	http://www.php.net	PHP v 3
DOJO-AJAX	http://www.dojotoolkit.org	BSD License
BOOST Library	http://www.boost.org	Boost Software v.1
ONC/RPC	http://www.plt.rwth-aachen.de	SUN
TightVnc	http://www.tightvnc.com	GPL v.3
DemoForgeMirageDriver	http://www.demoforge.com/dfmirage.htm	GPL v.3

Rohde&Schwarz would like to thank the open source community for their valuable contribution to embedded computing.

© 2009 Rohde & Schwarz GmbH & Co. KG
81671 Munich, Germany

Printed in Germany – Subject to change – Data without tolerance limits is not binding.

R&S® is a registered trademark of Rohde & Schwarz GmbH & Co. KG.

Trade names are trademarks of the owners.

The following abbreviations are used throughout this manual:
R&S®FSP is abbreviated as R&S FSP.

Contents

- Safety Instructions
- Safety Regulations for Batteries
- Information on Product Disposal
- Certificate of Quality
- EU Certificate of Conformity
- Support Center Address
- List of R&S Representatives
- Documentation Overview

- 1 Front and Rear Panel 1.1**
 - 1.1 Front View 1.2**
 - 1.2 Function Keys on the Front Panel 1.4**
 - 1.3 Front Panel Connections 1.6**
 - 1.4 Rear View 1.10**
 - 1.5 Rear Panel Connections 1.12**

- 2 Preparing for Use 2.1**
 - 2.1 Preparing for Operation 2.4**
 - 2.1.1 Unpacking the Instrument 2.4
 - 2.1.2 Setting Up the Instrument 2.4
 - 2.1.3 Installation in a 19" Rack 2.5
 - 2.1.4 Connecting the Instrument to the AC Power Supply 2.6
 - 2.1.5 Switching On the R&S FSP 2.6
 - 2.1.6 Functional Test 2.6
 - 2.1.7 Switching Off the R&S FSP 2.7
 - 2.1.8 Cleaning the Outside 2.8
 - 2.2 Instrument Drive Usage 2.8**
 - 2.3 Connecting External Devices 2.9**
 - 2.3.1 Connecting an External Keyboard 2.9
 - 2.3.2 Connecting a Mouse 2.11
 - 2.3.3 Connecting an External Monitor 2.12
 - 2.3.4 Connecting a Printer 2.13
 - 2.3.5 Connecting USB Devices (e.g. a Power Meter) 2.13

2.3.6	Connecting External Generators	2.15
2.3.6.1	Connecting the R&S FSP to the Generator	2.16
2.3.6.2	Configuring the Generator on the R&S FSP	2.16
2.3.6.3	Activating the Generator Configuration and Setting the Output Level	2.17
2.3.6.4	Using an External Generator as a Tracking Generator	2.18
2.4	Setup	2.19
2.4.1	Selecting the Frequency Reference	2.19
2.4.2	Setting the Date and Time	2.19
2.4.3	Setting the GPIB Interface	2.20
2.4.3.1	GPIB Address	2.20
2.4.3.2	GPIB Language	2.21
2.4.3.3	ID Response String	2.22
2.4.4	Setting the Screen Colors	2.23
2.4.5	Automatically Switching Off the Internal Screen	2.24
2.4.6	File and Path Selection Using the Front Panel Keys	2.25
2.4.7	Selecting and Configuring Printers	2.27
2.4.7.1	Selecting Alternative Printer Configurations	2.28
2.4.7.2	Selecting Printer Colors	2.28
2.4.8	Installing Plug&Play Printers	2.29
2.4.9	Installing Non-Plug&Play Printers	2.30
2.5	Configuring the LAN Interface (Option R&S FSP-B16 only)	2.30
2.5.1	Connecting the Instrument to the Network	2.30
2.5.2	Configuring the Network Card	2.30
2.5.2.1	Driver Installation	2.30
2.5.2.2	Configuring the Interface	2.31
2.5.2.3	Configuring Existing Network Protocols (TCP/IP Protocol)	2.31
2.5.2.4	Installing Additional Network Protocols and Services	2.35
2.5.3	Login	2.35
2.6	LXI Configuration	2.36
2.6.1	LXI Configuration Dialog	2.37
2.6.2	LXI Browser Interface	2.37
2.6.3	LAN Configuration website	2.38
2.6.4	Ping	2.38

2.7 Operating System Properties	2.39
2.7.1 Properties Specific to Windows XP	2.39
2.7.1.1 Windows XP Service Packs	2.39
2.7.1.2 Opening the Windows XP Start Menu	2.40
2.7.1.3 Windows XP Software Approved for the Instrument	2.40
3 Firmware Update and Installation of Firmware Options	3.1
3.1 Firmware Update	3.2
3.2 Activating Firmware Options	3.3
4 Basic Operation	4.1
4.1 Diagram Layout	4.2
4.1.1 Displays in the Diagram Area	4.3
4.2 Setting Parameters	4.7
4.2.1 The Keypad	4.7
4.2.2 The Rotary Knob and Arrow Keys	4.8
4.2.3 Editing Numeric Parameters	4.8
4.2.4 Editing Alphanumeric Parameters	4.9
4.2.4.1 Alphanumeric Editor Type 1:	4.9
4.2.4.2 Alphanumeric Editor Type 2:	4.10
5 Basic Measurement Examples	5.1
5.1 Measuring a Sinusoidal Signal	5.3
5.1.1 Measuring the Level and Frequency with Markers	5.3
5.1.1.1 Procedure	5.3
5.1.1.2 Increasing the Frequency Resolution	5.4
5.1.1.3 Setting the Reference Level	5.5
5.1.2 Measuring the Signal Frequency using the Frequency Counter	5.6
5.2 Measuring Harmonics of Sinusoidal Signals	5.8
5.2.1 Measuring the Suppression of the First and Second Harmonic of an Input Signal	5.8
5.2.2 Reducing Noise	5.9
5.3 Measuring Signal Spectra with Multiple Signals	5.11

5.3.1 Separating Signals by Selecting the Resolution Bandwidth	5.11
5.3.1.1 Separating Two Signals with a Level of -30 dBm each at a Frequency Spacing of 30 kHz	5.12
5.3.1.2 Measuring the Modulation Depth of an AM-Modulated Carrier in the Frequency Domain	5.16
5.4 Measurements in the Time Domain	5.17
5.4.1 Measuring the Power Characteristic	5.18
5.4.1.1 Example – Measuring the Power of a GSM Burst During the Activation Phase.	5.18
5.4.2 Measuring the Power Characteristic of Burst Signals ..	5.20
5.4.2.1 Example - Measuring the Edges of a GSM Burst with High Time Resolution	5.20
5.4.3 Measuring the Signal-to-Noise Ratio of Burst Signals ..	5.23
5.4.3.1 Example - Signal-to-Noise Ratio of a GSM Signal ..	5.23
5.4.4 Measurement of AM-Modulated Signals	5.26
5.4.4.1 Example – Displaying the AF of an AM-Modulated Signal in the Time Domain	5.26
5.4.5 Measurement of FM-Modulated Signals	5.28
5.4.5.1 Example - Display of the AF of an FM-Modulated Carrier	5.28
5.5 Storing and Loading Instrument Settings	5.31
5.5.1 Storing an Instrument Configuration (without Traces) ..	5.31
5.5.1.1 Storing Traces	5.32
5.5.2 Loading an Instrument Configuration	5.32
5.5.2.1 Automatic Loading of a Data Record during Bootling	5.33
5.6 Printing Out the Measurement Results	5.34
5.6.1 Selecting the Color Setting for the Printout	5.35
5.7 Additional Measurement Examples	5.35
6 LAN Interface	6.1
6.1 Installing Additional Network Protocols & Services	6.3
6.2 Configuration Examples	6.6
6.3 Subsequent Changes to the Network Configuration	6.6
6.4 Configuring the Windows XP Firewall	6.8
6.5 Operating the Instrument without a Network	6.9
6.6 Operating the Instrument in a Network	6.9

6.6.1	Creating Users	6.9
6.6.2	Changing the User Password	6.11
6.6.3	NOVELL Network only: Configure NOVELL Client	6.13
6.6.4	Logging On to the Network	6.14
6.6.5	Deactivating the Automatic Login Mechanism	6.14
6.6.6	Reactivating the Automatic Login Mechanism	6.14
6.6.7	Using Network Drives	6.15
6.6.8	Installing a Network Printer	6.17
6.6.9	Sharing Directories (only with Microsoft Networks)	6.21
6.7	Manual Operation of the R&S FSP with XP Remote Desktop	6.24
6.7.1	Introduction	6.24
6.7.2	Configuring the R&S FSP for Use of XP Remote Desktop	6.24
6.7.3	Configuring the Controller	6.27
6.7.4	Connection Setup with the R&S FSP	6.30
6.7.5	Interrupting and Restoring the Remote Desktop Connection with the R&S FSP	6.33
6.7.6	Deactivating the R&S FSP from the Controller	6.34
7	Brief Introduction to Remote Control	7.1
7.1	Basic Steps in Programming using the VISA Interface	7.3
7.1.1	Linking the VISA Library for Visual Basic	7.3
7.1.1.1	Programming notes:	7.3
7.1.2	Initialization and Default State	7.4
7.1.2.1	Creating Global Variables	7.4
7.1.2.2	Initializing the Controller	7.5
7.1.2.3	Initializing the Instrument	7.5
7.1.2.4	Switching the Screen Display On and Off	7.5
7.1.2.5	Configuring the Power Save Function for the Display	7.6
7.1.3	Sending Simple Instrument Setting Commands	7.6
7.1.4	Reading Out Instrument Settings	7.7
7.1.5	Marker Positioning and Readout	7.7
7.1.6	Command Synchronization	7.8
7.1.6.1	Reading Output Buffers	7.9
7.1.6.2	Reading Error Messages	7.9

7.2 Detailed Programming Examples	7.9
7.2.1 Default Settings of the R&S FSP	7.9
7.2.1.1 Setting the IEC Bus Status Registers	7.10
7.2.1.2 Default Settings for Measurements	7.10
7.2.2 Using Markers and Delta Markers	7.12
7.2.2.1 Marker Search Functions, Restricting the Search Range	7.12
7.2.2.2 Frequency Counting	7.13
7.2.2.3 Working with a Fixed Reference Point (Reference Fixed)	7.14
7.2.2.4 Measuring Noise and Phase Noise	7.15
7.2.3 Reading Out Trace Data	7.16
7.2.4 Storing and Loading Instrument Settings	7.18
7.2.4.1 Storing Instrument Settings	7.18
7.2.4.2 Loading Instrument Settings	7.19
7.2.4.3 Setting the Data Record for Startup Recall	7.20
7.2.5 Configuring and Starting a Printout	7.20

Appendix

Appendix A: Printer Interface	A.1
A.1 Installing USB Printers	A.2
A.2 Installing Non-Plug&Play Printers	A.6
A.2.1 Local Printer	A.6
A.2.2 Network Printer	A.12
Appendix B: External Generator Control	B.1
B.1 List of Generator Types Supported by the R&S FSP	B.1

Index

Basic Safety Instructions

Always read through and comply with the following safety instructions!









All plants and locations of the Rohde & Schwarz group of companies make every effort to keep the safety standards of our products up to date and to offer our customers the highest possible degree of safety. Our products and the auxiliary equipment they require are designed, built and tested in accordance with the safety standards that apply in each case. Compliance with these standards is continuously monitored by our quality assurance system. The product described here has been designed, built and tested in accordance with the attached EC Certificate of Conformity and has left the manufacturer's plant in a condition fully complying with safety standards. To maintain this condition and to ensure safe operation, you must observe all instructions and warnings provided in this manual. If you have any questions regarding these safety instructions, the Rohde & Schwarz group of companies will be happy to answer them.







Furthermore, it is your responsibility to use the product in an appropriate manner. This product is designed for use solely in industrial and laboratory environments or, if expressly permitted, also in the field and must not be used in any way that may cause personal injury or property damage. You are responsible if the product is used for any intention other than its designated purpose or in disregard of the manufacturer's instructions. The manufacturer shall assume no responsibility for such use of the product.

The product is used for its designated purpose if it is used in accordance with its product documentation and within its performance limits (see data sheet, documentation, the following safety instructions). Using the product requires technical skills and a basic knowledge of English. It is therefore essential that only skilled and specialized staff or thoroughly trained personnel with the required skills be allowed to use the product. If personal safety gear is required for using Rohde & Schwarz products, this will be indicated at the appropriate place in the product documentation. Keep the basic safety instructions and the product documentation in a safe place and pass them on to the subsequent users.

Observing the safety instructions will help prevent personal injury or damage of any kind caused by dangerous situations. Therefore, carefully read through and adhere to the following safety instructions before and when using the product. It is also absolutely essential to observe the additional safety instructions on personal safety, for example, that appear in relevant parts of the product documentation. In these safety instructions, the word "product" refers to all merchandise sold and distributed by the Rohde & Schwarz group of companies, including instruments, systems and all accessories.





Symbols and safety labels

							
Notice, general danger location Observe product documentation	Caution when handling heavy equipment	Danger of electric shock	Warning! Hot surface	PE terminal	Ground	Ground terminal	Be careful when handling electrostatic sensitive devices

					
ON/OFF supply voltage	Standby indication	Direct current (DC)	Alternating current (AC)	Direct/alternating current (DC/AC)	Device fully protected by double (reinforced) insulation

Tags and their meaning

The following signal words are used in the product documentation in order to warn the reader about risks and dangers.

	indicates a hazardous situation which, if not avoided, will result in death or serious injury.
	indicates a hazardous situation which, if not avoided, could result in death or serious injury.
	indicates a hazardous situation which, if not avoided, could result in minor or moderate injury.
	indicates the possibility of incorrect operation which can result in damage to the product. In the product documentation, the word ATTENTION is used synonymously.

These tags are in accordance with the standard definition for civil applications in the European Economic Area. Definitions that deviate from the standard definition may also exist in other economic areas or military applications. It is therefore essential to make sure that the tags described here are always used only in connection with the related product documentation and the related product. The use of tags in connection with unrelated products or documentation can result in misinterpretation and in personal injury or material damage.

Operating states and operating positions

The product may be operated only under the operating conditions and in the positions specified by the manufacturer, without the product's ventilation being obstructed. If the manufacturer's specifications are not observed, this can result in electric shock, fire and/or serious personal injury or death. Applicable local or national safety regulations and rules for the prevention of accidents must be observed in all work performed.

1. Unless otherwise specified, the following requirements apply to Rohde & Schwarz products: predefined operating position is always with the housing floor facing down, IP protection 2X, pollution severity 2, overvoltage category 2, use only indoors, max. operating altitude 2000 m above sea level, max. transport altitude 4500 m above sea level. A tolerance of $\pm 10\%$ shall apply to the nominal voltage and $\pm 5\%$ to the nominal frequency.
2. Do not place the product on surfaces, vehicles, cabinets or tables that for reasons of weight or stability are unsuitable for this purpose. Always follow the manufacturer's installation instructions when installing the product and fastening it to objects or structures (e.g. walls and shelves). An installation that is not carried out as described in the product documentation could result in personal injury or death.
3. Do not place the product on heat-generating devices such as radiators or fan heaters. The ambient temperature must not exceed the maximum temperature specified in the product documentation or in the data sheet. Product overheating can cause electric shock, fire and/or serious personal injury or death.

Electrical safety

If the information on electrical safety is not observed either at all to the extent necessary, electric shock, fire and/or serious personal injury or death may occur.

1. Prior to switching on the product, always ensure that the nominal voltage setting on the product matches the nominal voltage of the AC supply network. If a different voltage is to be set, the power fuse of the product may have to be changed accordingly.
2. In the case of products of safety class I with movable power cord and connector, operation is permitted only on sockets with an earthing contact and protective earth connection.
3. Intentionally breaking the protective earth connection either in the feed line or in the product itself is not permitted. Doing so can result in the danger of an electric shock from the product. If extension cords or connector strips are implemented, they must be checked on a regular basis to ensure that they are safe to use.
4. If the product does not have a power switch for disconnection from the AC supply network, the plug of the connecting cable is regarded as the disconnecting device. In such cases, always ensure that the power plug is easily reachable and accessible at all times (corresponding to the length of connecting cable, approx. 2 m). Functional or electronic switches are not suitable for providing disconnection from the AC supply network. If products without power switches are integrated into racks or systems, a disconnecting device must be provided at the system level.
5. Never use the product if the power cable is damaged. Check the power cable on a regular basis to ensure that it is in proper operating condition. By taking appropriate safety measures and carefully laying the power cable, you can ensure that the cable will not be damaged and that no one can be hurt by, for example, tripping over the cable or suffering an electric shock.
6. The product may be operated only from TN/TT supply networks fused with max. 16 A (higher fuse only after consulting with the Rohde & Schwarz group of companies).
7. Do not insert the plug into sockets that are dusty or dirty. Insert the plug firmly and all the way into the socket. Otherwise, sparks that result in fire and/or injuries may occur.
8. Do not overload any sockets, extension cords or connector strips; doing so can cause fire or electric shocks.
9. For measurements in circuits with voltages $V_{\text{rms}} > 30 \text{ V}$, suitable measures (e.g. appropriate measuring equipment, fusing, current limiting, electrical separation, insulation) should be taken to avoid any hazards.
10. Ensure that the connections with information technology equipment, e.g. PCs or other industrial computers, comply with the IEC60950-1/EN60950-1 or IEC61010-1/EN 61010-1 standards that apply in each case.
11. Unless expressly permitted, never remove the cover or any part of the housing while the product is in operation. Doing so will expose circuits and components and can lead to injuries, fire or damage to the product.
12. If a product is to be permanently installed, the connection between the PE terminal on site and the product's PE conductor must be made first before any other connection is made. The product may be installed and connected only by a licensed electrician.
13. For permanently installed equipment without built-in fuses, circuit breakers or similar protective devices, the supply circuit must be fused in such a way that anyone who has access to the product, as well as the product itself, is adequately protected from injury or damage.

Basic Safety Instructions

14. Use suitable overvoltage protection to ensure that no overvoltage (such as that caused by a bolt of lightning) can reach the product. Otherwise, the person operating the product will be exposed to the danger of an electric shock.
15. Any object that is not designed to be placed in the openings of the housing must not be used for this purpose. Doing so can cause short circuits inside the product and/or electric shocks, fire or injuries.
16. Unless specified otherwise, products are not liquid-proof (see also section "Operating states and operating positions", item 1. Therefore, the equipment must be protected against penetration by liquids. If the necessary precautions are not taken, the user may suffer electric shock or the product itself may be damaged, which can also lead to personal injury.
17. Never use the product under conditions in which condensation has formed or can form in or on the product, e.g. if the product has been moved from a cold to a warm environment. Penetration by water increases the risk of electric shock.
18. Prior to cleaning the product, disconnect it completely from the power supply (e.g. AC supply network or battery). Use a soft, non-linting cloth to clean the product. Never use chemical cleaning agents such as alcohol, acetone or diluents for cellulose lacquers.

Operation

1. Operating the products requires special training and intense concentration. Make sure that persons who use the products are physically, mentally and emotionally fit enough to do so; otherwise, injuries or material damage may occur. It is the responsibility of the employer/operator to select suitable personnel for operating the products.
2. Before you move or transport the product, read and observe the section titled "Transport".
3. As with all industrially manufactured goods, the use of substances that induce an allergic reaction (allergens) such as nickel cannot be generally excluded. If you develop an allergic reaction (such as a skin rash, frequent sneezing, red eyes or respiratory difficulties) when using a Rohde & Schwarz product, consult a physician immediately to determine the cause and to prevent health problems or stress.
4. Before you start processing the product mechanically and/or thermally, or before you take it apart, be sure to read and pay special attention to the section titled "Waste disposal", item 1.
5. Depending on the function, certain products such as RF radio equipment can produce an elevated level of electromagnetic radiation. Considering that unborn babies require increased protection, pregnant women must be protected by appropriate measures. Persons with pacemakers may also be exposed to risks from electromagnetic radiation. The employer/operator must evaluate workplaces where there is a special risk of exposure to radiation and, if necessary, take measures to avert the potential danger.
6. Should a fire occur, the product may release hazardous substances (gases, fluids, etc.) that can cause health problems. Therefore, suitable measures must be taken, e.g. protective masks and protective clothing must be worn.
7. If a laser product (e.g. a CD/DVD drive) is integrated into a Rohde & Schwarz product, absolutely no other settings or functions may be used as described in the product documentation. The objective is to prevent personal injury (e.g. due to laser beams).

Repair and service

1. The product may be opened only by authorized, specially trained personnel. Before any work is performed on the product or before the product is opened, it must be disconnected from the AC supply network. Otherwise, personnel will be exposed to the risk of an electric shock.
2. Adjustments, replacement of parts, maintenance and repair may be performed only by electrical experts authorized by Rohde & Schwarz. Only original parts may be used for replacing parts relevant to safety (e.g. power switches, power transformers, fuses). A safety test must always be performed after parts relevant to safety have been replaced (visual inspection, PE conductor test, insulation resistance measurement, leakage current measurement, functional test). This helps ensure the continued safety of the product.

Batteries and rechargeable batteries/cells

If the information regarding batteries and rechargeable batteries/cells is not observed either at all or to the extent necessary, product users may be exposed to the risk of explosions, fire and/or serious personal injury, and, in some cases, death. Batteries and rechargeable batteries with alkaline electrolytes (e.g. lithium cells) must be handled in accordance with the EN 62133 standard.

1. Cells must not be taken apart or crushed.
2. Cells or batteries must not be exposed to heat or fire. Storage in direct sunlight must be avoided. Keep cells and batteries clean and dry. Clean soiled connectors using a dry, clean cloth.
3. Cells or batteries must not be short-circuited. Cells or batteries must not be stored in a box or in a drawer where they can short-circuit each other, or where they can be short-circuited by other conductive materials. Cells and batteries must not be removed from their original packaging until they are ready to be used.
4. Keep cells and batteries out of the hands of children. If a cell or a battery has been swallowed, seek medical aid immediately.
5. Cells and batteries must not be exposed to any mechanical shocks that are stronger than permitted.
6. If a cell develops a leak, the fluid must not be allowed to come into contact with the skin or eyes. If contact occurs, wash the affected area with plenty of water and seek medical aid.
7. Improperly replacing or charging cells or batteries that contain alkaline electrolytes (e.g. lithium cells) can cause explosions. Replace cells or batteries only with the matching Rohde & Schwarz type (see parts list) in order to ensure the safety of the product.
8. Cells and batteries must be recycled and kept separate from residual waste. Rechargeable batteries and normal batteries that contain lead, mercury or cadmium are hazardous waste. Observe the national regulations regarding waste disposal and recycling.

Transport

1. The product may be very heavy. Therefore, the product must be handled with care. In some cases, the user may require a suitable means of lifting or moving the product (e.g. with a lift-truck) to avoid back or other physical injuries.

2. Handles on the products are designed exclusively to enable personnel to transport the product. It is therefore not permissible to use handles to fasten the product to or on transport equipment such as cranes, fork lifts, wagons, etc. The user is responsible for securely fastening the products to or on the means of transport or lifting. Observe the safety regulations of the manufacturer of the means of transport or lifting. Noncompliance can result in personal injury or material damage.
3. If you use the product in a vehicle, it is the sole responsibility of the driver to drive the vehicle safely and properly. The manufacturer assumes no responsibility for accidents or collisions. Never use the product in a moving vehicle if doing so could distract the driver of the vehicle. Adequately secure the product in the vehicle to prevent injuries or other damage in the event of an accident.

Waste disposal

1. If products or their components are mechanically and/or thermally processed in a manner that goes beyond their intended use, hazardous substances (heavy-metal dust such as lead, beryllium, nickel) may be released. For this reason, the product may only be disassembled by specially trained personnel. Improper disassembly may be hazardous to your health. National waste disposal regulations must be observed.
2. If handling the product releases hazardous substances or fuels that must be disposed of in a special way, e.g. coolants or engine oils that must be replenished regularly, the safety instructions of the manufacturer of the hazardous substances or fuels and the applicable regional waste disposal regulations must be observed. Also observe the relevant safety instructions in the product documentation. The improper disposal of hazardous substances or fuels can cause health problems and lead to environmental damage.

Informaciones elementales de seguridad

Es imprescindible leer y observar las siguientes instrucciones e informaciones de seguridad!

El principio del grupo de empresas Rohde & Schwarz consiste en tener nuestros productos siempre al día con los estándares de seguridad y de ofrecer a nuestros clientes el máximo grado de seguridad. Nuestros productos y todos los equipos adicionales son siempre fabricados y examinados según las normas de seguridad vigentes. Nuestro sistema de garantía de calidad controla constantemente que sean cumplidas estas normas. El presente producto ha sido fabricado y examinado según el certificado de conformidad adjunto de la UE y ha salido de nuestra planta en estado impecable según los estándares técnicos de seguridad. Para poder preservar este estado y garantizar un funcionamiento libre de peligros, el usuario deberá atenerse a todas las indicaciones, informaciones de seguridad y notas de alerta. El grupo de empresas Rohde & Schwarz está siempre a su disposición en caso de que tengan preguntas referentes a estas informaciones de seguridad.

Además queda en la responsabilidad del usuario utilizar el producto en la forma debida. Este producto está destinado exclusivamente al uso en la industria y el laboratorio o, si ha sido expresamente autorizado, para aplicaciones de campo y de ninguna manera deberá ser utilizado de modo que alguna persona/cosa pueda sufrir daño. El uso del producto fuera de sus fines definidos o sin tener en cuenta las instrucciones del fabricante queda en la responsabilidad del usuario. El fabricante no se hace en ninguna forma responsable de consecuencias a causa del mal uso del producto.







Informaciones elementales de seguridad

Se parte del uso correcto del producto para los fines definidos si el producto es utilizado conforme a las indicaciones de la correspondiente documentación del producto y dentro del margen de rendimiento definido (ver hoja de datos, documentación, informaciones de seguridad que siguen). El uso del producto hace necesarios conocimientos técnicos y ciertos conocimientos del idioma inglés. Por eso se debe tener en cuenta que el producto solo pueda ser operado por personal especializado o personas instruidas en profundidad con las capacidades correspondientes. Si fuera necesaria indumentaria de seguridad para el uso de productos de Rohde & Schwarz, encontraría la información debida en la documentación del producto en el capítulo correspondiente. Guarde bien las informaciones de seguridad elementales, así como la documentación del producto, y entréguelas a usuarios posteriores.

Tener en cuenta las informaciones de seguridad sirve para evitar en lo posible lesiones o daños por peligros de toda clase. Por eso es imprescindible leer detalladamente y comprender por completo las siguientes informaciones de seguridad antes de usar el producto, y respetarlas durante el uso del producto. Deberán tenerse en cuenta todas las demás informaciones de seguridad, como p. ej. las referentes a la protección de personas, que encontrarán en el capítulo correspondiente de la documentación del producto y que también son de obligado cumplimiento. En las presentes informaciones de seguridad se recogen todos los objetos que distribuye el grupo de empresas Rohde & Schwarz bajo la denominación de "producto", entre ellos también aparatos, instalaciones así como toda clase de accesorios.

Símbolos y definiciones de seguridad

							
Aviso: punto de peligro general Observar la documentación del producto	Atención en el manejo de dispositivos de peso elevado	Peligro de choque eléctrico	Advertencia: superficie caliente	Conexión a conductor de protección	Conexión a tierra	Conexión a masa	Aviso: Cuidado en el manejo de dispositivos sensibles a la electrostática (ESD)

					
Tensión de alimentación de PUESTA EN MARCHA / PARADA	Indicación de estado de espera (Standby)	Corriente continua (DC)	Corriente alterna (AC)	Corriente continua / Corriente alterna (DC/AC)	El aparato está protegido en su totalidad por un aislamiento doble (reforzado)

Palabras de señal y su significado

En la documentación del producto se utilizan las siguientes palabras de señal con el fin de advertir contra riesgos y peligros.



PELIGRO identifica un peligro inminente con riesgo elevado que provocará muerte o lesiones graves si no se evita.



ADVERTENCIA identifica un posible peligro con riesgo medio de provocar muerte o lesiones (graves) si no se evita.



ATENCIÓN identifica un peligro con riesgo reducido de provocar lesiones leves o moderadas si no se evita.



AVISO indica la posibilidad de utilizar mal el producto y, como consecuencia, dañarlo.

En la documentación del producto se emplea de forma sinónima el término CUIDADO.

Las palabras de señal corresponden a la definición habitual para aplicaciones civiles en el área económica europea. Pueden existir definiciones diferentes a esta definición en otras áreas económicas o en aplicaciones militares. Por eso se deberá tener en cuenta que las palabras de señal aquí descritas sean utilizadas siempre solamente en combinación con la correspondiente documentación del producto y solamente en combinación con el producto correspondiente. La utilización de las palabras de señal en combinación con productos o documentaciones que no les correspondan puede llevar a interpretaciones equivocadas y tener por consecuencia daños en personas u objetos.

Estados operativos y posiciones de funcionamiento

El producto solamente debe ser utilizado según lo indicado por el fabricante respecto a los estados operativos y posiciones de funcionamiento sin que se obstruya la ventilación. Si no se siguen las indicaciones del fabricante, pueden producirse choques eléctricos, incendios y/o lesiones graves con posible consecuencia de muerte. En todos los trabajos deberán ser tenidas en cuenta las normas nacionales y locales de seguridad del trabajo y de prevención de accidentes.

1. Si no se convino de otra manera, es para los productos Rohde & Schwarz válido lo que sigue: como posición de funcionamiento se define por principio la posición con el suelo de la caja para abajo, modo de protección IP 2X, grado de suciedad 2, categoría de sobrecarga eléctrica 2, uso solamente en estancias interiores, utilización hasta 2000 m sobre el nivel del mar, transporte hasta 4500 m sobre el nivel del mar. Se aplicará una tolerancia de $\pm 10\%$ sobre el voltaje nominal y de $\pm 5\%$ sobre la frecuencia nominal.
2. No sitúe el producto encima de superficies, vehículos, estantes o mesas, que por sus características de peso o de estabilidad no sean aptos para él. Siga siempre las instrucciones de instalación del fabricante cuando instale y asegure el producto en objetos o estructuras (p. ej. paredes y estantes). Si se realiza la instalación de modo distinto al indicado en la documentación del producto, pueden causarse lesiones o incluso la muerte.
3. No ponga el producto sobre aparatos que generen calor (p. ej. radiadores o calefactores). La temperatura ambiente no debe superar la temperatura máxima especificada en la documentación del producto o en la hoja de datos. En caso de sobrecalentamiento del producto, pueden producirse choques eléctricos, incendios y/o lesiones graves con posible consecuencia de muerte.

Seguridad eléctrica

Si no se siguen (o se siguen de modo insuficiente) las indicaciones del fabricante en cuanto a seguridad eléctrica, pueden producirse choques eléctricos, incendios y/o lesiones graves con posible consecuencia de muerte.

1. Antes de la puesta en marcha del producto se deberá comprobar siempre que la tensión preseleccionada en el producto coincida con la de la red de alimentación eléctrica. Si es necesario modificar el ajuste de tensión, también se deberán cambiar en caso dado los fusibles correspondientes del producto.
2. Los productos de la clase de protección I con alimentación móvil y enchufe individual solamente podrán enchufarse a tomas de corriente con contacto de seguridad y con conductor de protección conectado.
3. Queda prohibida la interrupción intencionada del conductor de protección, tanto en la toma de corriente como en el mismo producto. La interrupción puede tener como consecuencia el riesgo de que el producto sea fuente de choques eléctricos. Si se utilizan cables alargadores o regletas de enchufe, deberá garantizarse la realización de un examen regular de los mismos en cuanto a su estado técnico de seguridad.
4. Si el producto no está equipado con un interruptor para desconectarlo de la red, se deberá considerar el enchufe del cable de conexión como interruptor. En estos casos se deberá asegurar que el enchufe siempre sea de fácil acceso (de acuerdo con la longitud del cable de conexión, aproximadamente 2 m). Los interruptores de función o electrónicos no son aptos para el corte de la red eléctrica. Si los productos sin interruptor están integrados en bastidores o instalaciones, se deberá colocar el interruptor en el nivel de la instalación.
5. No utilice nunca el producto si está dañado el cable de conexión a red. Compruebe regularmente el correcto estado de los cables de conexión a red. Asegúrese, mediante las medidas de protección y de instalación adecuadas, de que el cable de conexión a red no pueda ser dañado o de que nadie pueda ser dañado por él, p. ej. al tropezar o por un choque eléctrico.
6. Solamente está permitido el funcionamiento en redes de alimentación TN/TT aseguradas con fusibles de 16 A como máximo (utilización de fusibles de mayor amperaje solo previa consulta con el grupo de empresas Rohde & Schwarz).
7. Nunca conecte el enchufe en tomas de corriente sucias o llenas de polvo. Introduzca el enchufe por completo y fuertemente en la toma de corriente. La no observación de estas medidas puede provocar chispas, fuego y/o lesiones.
8. No sobrecargue las tomas de corriente, los cables alargadores o las regletas de enchufe ya que esto podría causar fuego o choques eléctricos.
9. En las mediciones en circuitos de corriente con una tensión $U_{\text{eff}} > 30 \text{ V}$ se deberán tomar las medidas apropiadas para impedir cualquier peligro (p. ej. medios de medición adecuados, seguros, limitación de tensión, corte protector, aislamiento etc.).
10. Para la conexión con dispositivos informáticos como un PC o un ordenador industrial, debe comprobarse que éstos cumplan los estándares IEC60950-1/EN60950-1 o IEC61010-1/EN 61010-1 válidos en cada caso.
11. A menos que esté permitido expresamente, no retire nunca la tapa ni componentes de la carcasa mientras el producto esté en servicio. Esto pone a descubierto los cables y componentes eléctricos y puede causar lesiones, fuego o daños en el producto.

12. Si un producto se instala en un lugar fijo, se deberá primero conectar el conductor de protección fijo con el conductor de protección del producto antes de hacer cualquier otra conexión. La instalación y la conexión deberán ser efectuadas por un electricista especializado.
13. En el caso de dispositivos fijos que no estén provistos de fusibles, interruptor automático ni otros mecanismos de seguridad similares, el circuito de alimentación debe estar protegido de modo que todas las personas que puedan acceder al producto, así como el producto mismo, estén a salvo de posibles daños.
14. Todo producto debe estar protegido contra sobretensión (debida p. ej. a una caída del rayo) mediante los correspondientes sistemas de protección. Si no, el personal que lo utilice quedará expuesto al peligro de choque eléctrico.
15. No debe introducirse en los orificios de la caja del aparato ningún objeto que no esté destinado a ello. Esto puede producir cortocircuitos en el producto y/o puede causar choques eléctricos, fuego o lesiones.
16. Salvo indicación contraria, los productos no están impermeabilizados (ver también el capítulo "Estados operativos y posiciones de funcionamiento", punto 1). Por eso es necesario tomar las medidas necesarias para evitar la entrada de líquidos. En caso contrario, existe peligro de choque eléctrico para el usuario o de daños en el producto, que también pueden redundar en peligro para las personas.
17. No utilice el producto en condiciones en las que pueda producirse o ya se hayan producido condensaciones sobre el producto o en el interior de éste, como p. ej. al desplazarlo de un lugar frío a otro caliente. La entrada de agua aumenta el riesgo de choque eléctrico.
18. Antes de la limpieza, desconecte por completo el producto de la alimentación de tensión (p. ej. red de alimentación o batería). Realice la limpieza de los aparatos con un paño suave, que no se deshilache. No utilice bajo ningún concepto productos de limpieza químicos como alcohol, acetona o diluyentes para lacas nitrocelulósicas.

Funcionamiento

1. El uso del producto requiere instrucciones especiales y una alta concentración durante el manejo. Debe asegurarse que las personas que manejen el producto estén a la altura de los requerimientos necesarios en cuanto a aptitudes físicas, psíquicas y emocionales, ya que de otra manera no se pueden excluir lesiones o daños de objetos. El empresario u operador es responsable de seleccionar el personal usuario apto para el manejo del producto.
2. Antes de desplazar o transportar el producto, lea y tenga en cuenta el capítulo "Transporte".
3. Como con todo producto de fabricación industrial no puede quedar excluida en general la posibilidad de que se produzcan alergias provocadas por algunos materiales empleados, los llamados alérgenos (p. ej. el níquel). Si durante el manejo de productos Rohde & Schwarz se producen reacciones alérgicas, como p. ej. irritaciones cutáneas, estornudos continuos, enrojecimiento de la conjuntiva o dificultades respiratorias, debe avisarse inmediatamente a un médico para investigar las causas y evitar cualquier molestia o daño a la salud.
4. Antes de la manipulación mecánica y/o térmica o el desmontaje del producto, debe tenerse en cuenta imprescindiblemente el capítulo "Eliminación", punto 1.

5. Ciertos productos, como p. ej. las instalaciones de radiocomunicación RF, pueden a causa de su función natural, emitir una radiación electromagnética aumentada. Deben tomarse todas las medidas necesarias para la protección de las mujeres embarazadas. También las personas con marcapasos pueden correr peligro a causa de la radiación electromagnética. El empresario/operador tiene la obligación de evaluar y señalar las áreas de trabajo en las que exista un riesgo elevado de exposición a radiaciones.
6. Tenga en cuenta que en caso de incendio pueden desprenderse del producto sustancias tóxicas (gases, líquidos etc.) que pueden generar daños a la salud. Por eso, en caso de incendio deben usarse medidas adecuadas, como p. ej. máscaras antigás e indumentaria de protección.
7. En caso de que un producto Rohde & Schwarz contenga un producto láser (p. ej. un lector de CD/DVD), no debe usarse ninguna otra configuración o función aparte de las descritas en la documentación del producto, a fin de evitar lesiones (p. ej. debidas a irradiación láser).

Reparación y mantenimiento

1. El producto solamente debe ser abierto por personal especializado con autorización para ello. Antes de manipular el producto o abrirlo, es obligatorio desconectarlo de la tensión de alimentación, para evitar toda posibilidad de choque eléctrico.
2. El ajuste, el cambio de partes, el mantenimiento y la reparación deberán ser efectuadas solamente por electricistas autorizados por Rohde & Schwarz. Si se reponen partes con importancia para los aspectos de seguridad (p. ej. el enchufe, los transformadores o los fusibles), solamente podrán ser sustituidos por partes originales. Después de cada cambio de partes relevantes para la seguridad deberá realizarse un control de seguridad (control a primera vista, control del conductor de protección, medición de resistencia de aislamiento, medición de la corriente de fuga, control de funcionamiento). Con esto queda garantizada la seguridad del producto.

Baterías y acumuladores o celdas

Si no se siguen (o se siguen de modo insuficiente) las indicaciones en cuanto a las baterías y acumuladores o celdas, pueden producirse explosiones, incendios y/o lesiones graves con posible consecuencia de muerte. El manejo de baterías y acumuladores con electrolitos alcalinos (p. ej. celdas de litio) debe seguir el estándar EN 62133.

1. No deben desmontarse, abrirse ni triturarse las celdas.
2. Las celdas o baterías no deben someterse a calor ni fuego. Debe evitarse el almacenamiento a la luz directa del sol. Las celdas y baterías deben mantenerse limpias y secas. Limpiar las conexiones sucias con un paño seco y limpio.
3. Las celdas o baterías no deben cortocircuitarse. Es peligroso almacenar las celdas o baterías en estuches o cajones en cuyo interior puedan cortocircuitarse por contacto recíproco o por contacto con otros materiales conductores. No deben extraerse las celdas o baterías de sus embalajes originales hasta el momento en que vayan a utilizarse.
4. Mantener baterías y celdas fuera del alcance de los niños. En caso de ingestión de una celda o batería, avisar inmediatamente a un médico.
5. Las celdas o baterías no deben someterse a impactos mecánicos fuertes indebidos.

Informaciones elementales de seguridad

6. En caso de falta de estanqueidad de una celda, el líquido vertido no debe entrar en contacto con la piel ni los ojos. Si se produce contacto, lavar con agua abundante la zona afectada y avisar a un médico.
7. En caso de cambio o recarga inadecuados, las celdas o baterías que contienen electrolitos alcalinos (p. ej. las celdas de litio) pueden explotar. Para garantizar la seguridad del producto, las celdas o baterías solo deben ser sustituidas por el tipo Rohde & Schwarz correspondiente (ver lista de recambios).
8. Las baterías y celdas deben reciclarse y no deben tirarse a la basura doméstica. Las baterías o acumuladores que contienen plomo, mercurio o cadmio deben tratarse como residuos especiales. Respete en esta relación las normas nacionales de eliminación y reciclaje.

Transporte

1. El producto puede tener un peso elevado. Por eso es necesario desplazarlo o transportarlo con precaución y, si es necesario, usando un sistema de elevación adecuado (p. ej. una carretilla elevadora), a fin de evitar lesiones en la espalda u otros daños personales.
2. Las asas instaladas en los productos sirven solamente de ayuda para el transporte del producto por personas. Por eso no está permitido utilizar las asas para la sujeción en o sobre medios de transporte como p. ej. grúas, carretillas elevadoras de horquilla, carros etc. Es responsabilidad suya fijar los productos de manera segura a los medios de transporte o elevación. Para evitar daños personales o daños en el producto, siga las instrucciones de seguridad del fabricante del medio de transporte o elevación utilizado.
3. Si se utiliza el producto dentro de un vehículo, recae de manera exclusiva en el conductor la responsabilidad de conducir el vehículo de manera segura y adecuada. El fabricante no asumirá ninguna responsabilidad por accidentes o colisiones. No utilice nunca el producto dentro de un vehículo en movimiento si esto pudiera distraer al conductor. Asegure el producto dentro del vehículo debidamente para evitar, en caso de un accidente, lesiones u otra clase de daños.

Eliminación

1. Si se trabaja de manera mecánica y/o térmica cualquier producto o componente más allá del funcionamiento previsto, pueden liberarse sustancias peligrosas (polveros con contenido de metales pesados como p. ej. plomo, berilio o níquel). Por eso el producto solo debe ser desmontado por personal especializado con formación adecuada. Un desmontaje inadecuado puede ocasionar daños para la salud. Se deben tener en cuenta las directivas nacionales referentes a la eliminación de residuos.
2. En caso de que durante el trato del producto se formen sustancias peligrosas o combustibles que deban tratarse como residuos especiales (p. ej. refrigerantes o aceites de motor con intervalos de cambio definidos), deben tenerse en cuenta las indicaciones de seguridad del fabricante de dichas sustancias y las normas regionales de eliminación de residuos. Tenga en cuenta también en caso necesario las indicaciones de seguridad especiales contenidas en la documentación del producto. La eliminación incorrecta de sustancias peligrosas o combustibles puede causar daños a la salud o daños al medio ambiente.

Qualitätszertifikat

Certificate of quality

Certificat de qualité

Certified Quality System
ISO 9001

Certified Environmental System
ISO 14001

Sehr geehrter Kunde,

Sie haben sich für den Kauf eines Rohde&Schwarz-Produktes entschieden. Hiermit erhalten Sie ein nach modernsten Fertigungsmethoden hergestelltes Produkt. Es wurde nach den Regeln unseres Qualitätsmanagementsystems entwickelt, gefertigt und geprüft. Das Rohde&Schwarz-Qualitätsmanagementsystem ist u.a. nach ISO9001 und ISO14001 zertifiziert.

Der Umwelt verpflichtet

- ▮ Energie-effiziente, RoHS-konforme Produkte
- ▮ Kontinuierliche Weiterentwicklung nachhaltiger Umweltkonzepte
- ▮ ISO 14001-zertifiziertes Umweltmanagementsystem

Dear Customer,

You have decided to buy a Rohde&Schwarz product. You are thus assured of receiving a product that is manufactured using the most modern methods available. This product was developed, manufactured and tested in compliance with our quality management system standards. The Rohde&Schwarz quality management system is certified according to standards such as ISO9001 and ISO14001.

Environmental commitment

- ▮ Energy-efficient products
- ▮ Continuous improvement in environmental sustainability
- ▮ ISO 14001-certified environmental management system

Cher client,

Vous avez choisi d'acheter un produit Rohde&Schwarz. Vous disposez donc d'un produit fabriqué d'après les méthodes les plus avancées. Le développement, la fabrication et les tests respectent nos normes de gestion qualité. Le système de gestion qualité de Rohde&Schwarz a été homologué, entre autres, conformément aux normes ISO9001 et ISO14001.

Engagement écologique

- ▮ Produits à efficience énergétique
- ▮ Amélioration continue de la durabilité environnementale
- ▮ Système de gestion de l'environnement certifié selon ISO 14001

Customer Support

Technical support – where and when you need it

For quick, expert help with any Rohde & Schwarz equipment, contact one of our Customer Support Centers. A team of highly qualified engineers provides telephone support and will work with you to find a solution to your query on any aspect of the operation, programming or applications of Rohde & Schwarz equipment.

Up-to-date information and upgrades

To keep your instrument up-to-date and to be informed about new application notes related to your instrument, please send an e-mail to the Customer Support Center stating your instrument and your wish. We will take care that you will get the right information.

USA & Canada

Monday to Friday (except US public holidays)
8:00 AM – 8:00 PM Eastern Standard Time (EST)

Tel. from USA 888-test-rsa (888-837-8772) (opt 2)
From outside USA +1 410 910 7800 (opt 2)
Fax +1 410 910 7801

E-mail CustomerSupport@rohde-schwarz.com

East Asia

Monday to Friday (except Singaporean public holidays)
8:30 AM – 6:00 PM Singapore Time (SGT)

Tel. +65 6 513 0488
Fax +65 6 846 1090

E-mail CustomerSupport@rohde-schwarz.com

Rest of the World

Monday to Friday (except German public holidays)
08:00 – 17:00 Central European Time (CET)

Tel. +49 89 4129 13774
Fax +49 (0) 89 41 29 637 78

E-mail CustomerSupport@rohde-schwarz.com



Customer Information Regarding Product Disposal

The German Electrical and Electronic Equipment (ElektroG) Act is an implementation of the following EC directives:

- 2002/96/EC on waste electrical and electronic equipment (WEEE) and
- 2002/95/EC on the restriction of the use of certain hazardous substances in electrical and electronic equipment (RoHS).

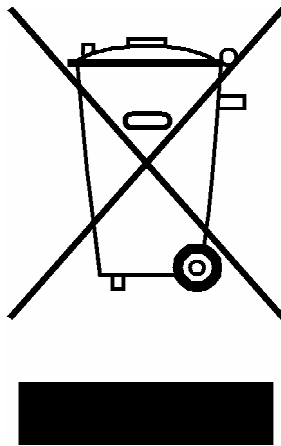

Product labeling in accordance with EN 50419

Once the lifetime of a product has ended, this product must not be disposed of in the standard domestic refuse. Even disposal via the municipal collection points for waste electrical and electronic equipment is not permitted.

Rohde & Schwarz GmbH & Co. KG has developed a disposal concept for the environmental-friendly disposal or recycling of waste material and fully assumes its obligation as a producer to take back and dispose of electrical and electronic waste in accordance with the ElektroG Act.

Please contact your local service representative to dispose of the product.





ROHDE & SCHWARZ
EC Certificate of Conformity



Certificate No.: 2003-22, Page 1

This is to certify that:

Equipment type	Stock No.	Designation
FSP3	1164.4391.03	Spectrum Analyzer
FSP7	1164.4391.07	
FSP13	1164.4391.13	
FSP30	1164.4391.30	
FSP31	1164.4391.31	
FSP40	1164.4391.40	

complies with the provisions of the Directive of the Council of the European Union on the approximation of the laws of the Member States

- relating to electrical equipment for use within defined voltage limits (2006/95/EC)
- relating to electromagnetic compatibility (2004/108/EC)

Conformity is proven by compliance with the following standards:

EN61010-1 : 2001-12
EN55011 : 1998 + A1 : 1999 + A2 : 2002, Class B
EN61326 : 1997 + A1 : 1998 + A2 : 2001 + A3 : 2003

For the assessment of electromagnetic compatibility, the limits of radio interference for Class B equipment as well as the immunity to interference for operation in industry have been used as a basis.

Affixing the EC conformity mark as from 2003

Munich, 2008-03-31

ROHDE & SCHWARZ GmbH & Co. KG
Mühldorfstr. 15, D-81671 München

Central Quality Management MF-QZ / Radde



Certificate No.: 2003-22, Page 2

This is to certify that:

Equipment type	Stock No.	Designation
FSP-B3	1129.6491.02	Audio Modulator AM/FM
FSP-B4	1129.6740.02	OCXO 10 MHz
FSP-B6	1129.8594.02	TV-Trigger
FSP-B9	1129.6991.02	Tracking Generator
FSP-B10	1129.7246.02/.03	External Generator Control
FSP-B15	1155.1006.02	Pulse Calibrator
FSP-B16	1129.8042.03	Lan Interface 10/1000 Base T
FSP-B18	1163.0892.02/.03	Removable Hard Disk
FSP-B19	1163.1124.02/.03	Second Hard Disk
FSP-B20	1155.1606.02/.06/.10	Extended Environmental Spec
FSP-B21	1155.1758.02	LO/IF Connections
FSP-B25	1129.7746.02	Electronic Attenuator
FSP-B28	1162.9915.02	Trigger Port
FSP-B29	1163.0663.07/.30/.40	20 Hz Frequency Extension
FSP-B30	1155.1158.02	DC Power Supply
FSP-B31	1155.1258.02	NIMH Battery Pack and Charger
FSP-B32	1155.1506.02	Spare Battery Pack (NIMH)
FSP-B70	1157.0559.02	Demodulator HW and Memory Extension

complies with the provisions of the Directive of the Council of the European Union on the approximation of the laws of the Member States

- relating to electrical equipment for use within defined voltage limits (2006/95/EC)
- relating to electromagnetic compatibility (2004/108/EC)

Conformity is proven by compliance with the following standards:

EN61010-1 : 2001-12
 EN55011 : 1998 + A1 : 1999 + A2 : 2002, Class B
 EN61326 : 1997 + A1 : 1998 + A2 : 2001 + A3 : 2003

For the assessment of electromagnetic compatibility, the limits of radio interference for Class B equipment as well as the immunity to interference for operation in industry have been used as a basis.

Affixing the EC conformity mark as from 2003

ROHDE & SCHWARZ GmbH & Co. KG
Mühdorfstr. 15, D-81671 München

Munich, 2008-03-31

Central Quality Management MF-QZ / Radde

Documentation Overview

The documentation of the R&S FSP consists of base unit manuals and option manuals. All manuals are provided in PDF format on the CD-ROM delivered with the instrument. Each software option available for the instrument is described in a separate software manual.

The base unit documentation comprises the following manuals and documents:

- [Quick Start Guide](#)
- [Operating Manual](#)
- [Service Manual](#)
- [Release Notes](#)

Apart from the base unit, these manuals describe the models and options of the R&S FSP Spectrum Analyzer that are listed in the documentation overview of the Operating Manual. All other options are described in separate manuals. These manuals are provided on the CD-ROM. For an overview of all options available for the R&S FSP visit the R&S FSP Spectrum Analyzer Internet site.

Quick Start Guide

This manual is delivered with the instrument in printed form and in PDF format on the CD-ROM. It provides the information needed to set up and start working with the instrument. Basic operations and basic measurements are described. Also a brief introduction to remote control is given. More detailed descriptions are provided in the Operating Manual. The Quick Start Guide includes general information (e.g. Safety Instructions) and the following chapters:

Chapter 1	Front and Rear Panel
Chapter 2	Preparing for Use
Chapter 3	Firmware-Update and Installation of Firmware Options
Chapter 4	Basic Operation
Chapter 5	Basic Measurement Examples
Chapter 6	LAN Interface
Chapter 7	Brief Introduction to Remote Control
Appendix A	Printer Interface
Appendix B	External Generator Control

Operating Manual

This manual is a supplement to the Quick Start Guide and is available in PDF format on the CD-ROM delivered with the instrument. To retain the familiar structure that applies to all Operating Manuals of Rohde&Schwarz Test & Measurement instruments, the chapters 1 and 3 exist, but only in form of references to the corresponding Quick Start Guide chapters.

The Operating Manual is subdivided into the following chapters:

- Chapter 1** Putting into Operation
see Quick Start Guide chapters 1 and 2.
- Chapter 2** Getting Started
gives an introduction to advanced measurement tasks of the R&S FSP which are explained step by step.
- Chapter 3** Manual Operation
see Quick Start Guide chapter 4
- Chapter 4** Instrument Functions
forms a reference for manual operation of the R&S FSP and contains a detailed description of all instrument functions and their application.
- Chapter 5** Remote Control - Basics
describes the basics for programming the R&S FSP, command processing and the status reporting system.
- Chapter 6** Remote Control - Description of Commands
lists all the remote-control commands defined for the instrument.
- Chapter 7** Remote Control - Programming Examples
contains program examples for a number of typical applications of the R&S FSP.
- Chapter 8** Maintenance and Instrument Interfaces
describes preventive maintenance and the characteristics of the instrument's interfaces.
- Chapter 9** Error Messages
gives a list of error messages that the R&S FSP may generate.
- Index** contains an index for the chapters 1 to 9 of the Operating Manual.

Service Manual

This manual is available in PDF format on the CD-ROM delivered with the instrument. It informs on how to check compliance with rated specifications, on instrument function, repair, troubleshooting and fault elimination. It contains all information required for repairing the R&S FSP by the replacement of modules. The manual includes the following chapters:

- Chapter 1** Performance Test
- Chapter 2** Adjustment
- Chapter 3** Repair
- Chapter 4** Software Update / Installing Options
- Chapter 5** Documents

Internet Site

The Internet site at: [R&S FSP Spectrum Analyzer](#) provides the most up to date information on the R&S FSP. The current operating manual at a time is available as printable PDF file in the download area. Also provided for download are firmware updates including the associated release notes, instrument drivers, current data sheets and application notes.

Release Notes

The release notes describe the installation of the firmware, new and modified functions, eliminated problems, and last minute changes to the documentation. The corresponding firmware version is indicated on the title page of the release notes. The current release notes are provided in the Internet.

1 Front and Rear Panel

1.1 Front View	1.2
1.2 Function Keys on the Front Panel	1.4
1.3 Front Panel Connections	1.6
1.4 Rear View	1.10
1.5 Rear Panel Connections	1.12

1.1 Front View

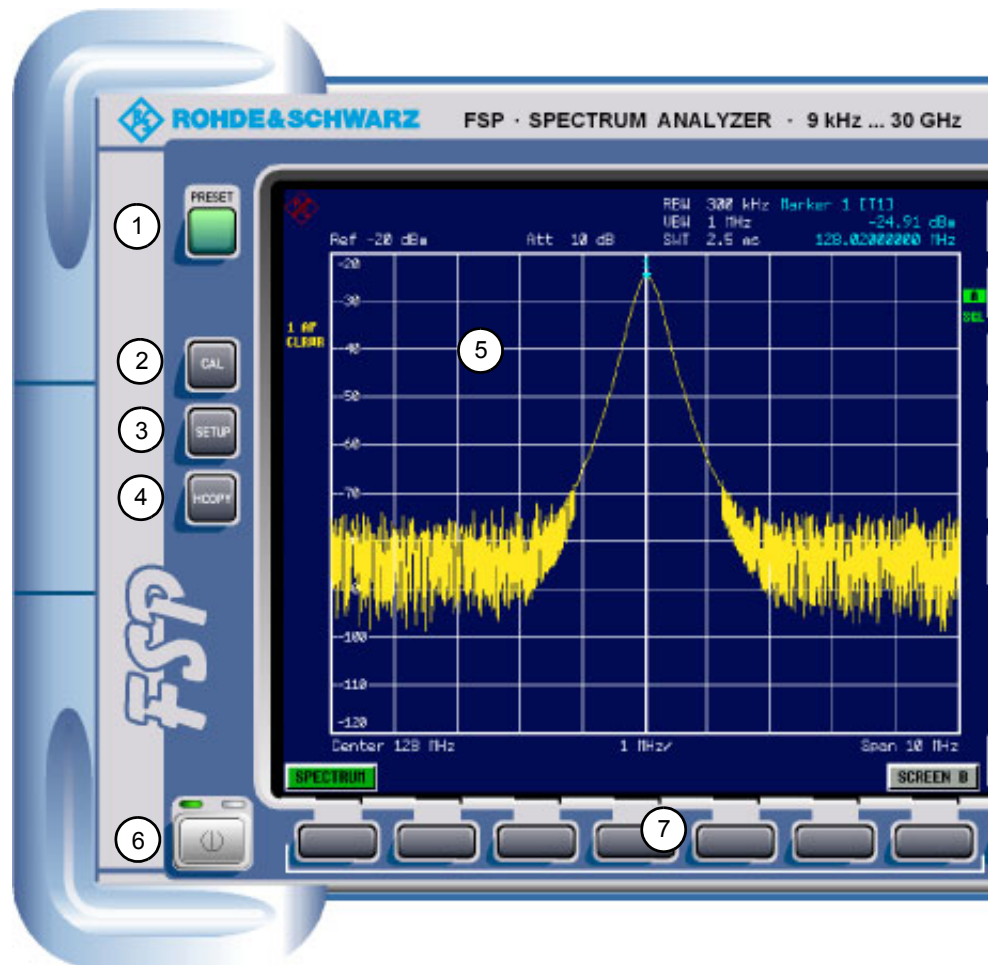
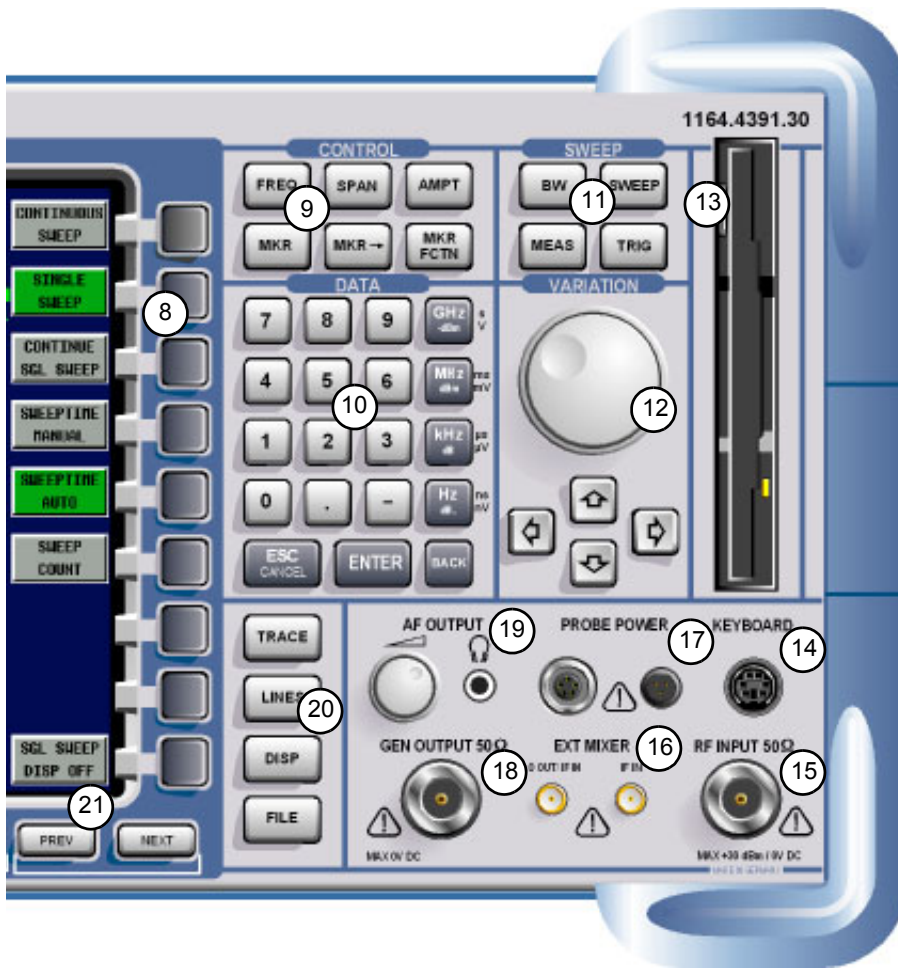

Fig. 1-1 Front view

Number in Fig. 1-1	Description
1	PRESET key (see "Function Keys on the Front Panel")
2	Calibration key (see "Function Keys on the Front Panel")
3	SETUP key (see "Function Keys on the Front Panel")
4	HCOPI key (see "Function Keys on the Front Panel")
5	screen
6	ON/standby switch (see "Function Keys on the Front Panel")
7	hotkeys
8	softkeys
9	function keys for frequency, level, and markers (see "Function Keys on the Front Panel")
10	numeric keypad, units and entry keys
11	function keys for bandwidth, sweep, trigger, and measurement functions (see "Function Keys on the Front Panel")



Number in Fig. 1-1	Description
12	rotary knob with enter function and arrow keys
13	3.5" disk drive, 1.44 MByte (see page 8); option R&S FSP-B18 replaces the disk drive by a compact flash card drive (see page 9)
14	PS/2 keyboard (see page 8)
15	RF input (see page 6)
16	external mixer (LO output, IF input), option R&S FSP-B21 (see page 6)
17	probe power connector - supply voltage for measurement accessories (see page 7)
18	tracking generator output, option R&S FSP-B9 (see page 6)
19	AF output with volume control, option R&S FSP-B3 (see page 7)
20	TRACE key, LINES key, DISP key, FILE key (see "Function Keys on the Front Panel")
21	PREVIOUS key, NEXT key (softkey side menus)

Function Keys on the Front Panel

1.2 Function Keys on the Front Panel

A detailed description of the corresponding menus and the other function keys is provided in the Operating Manual on CD-ROM.

Function key	Assigned functions
ON/STANDBY	Switches the instrument on and off.
PRESET	Resets the instrument to the default state.
FREQ	Sets the center frequency as well as the start and stop frequencies for the frequency band under consideration. This key is also used to set the frequency offset and the signal track function.
SPAN	Sets the frequency span to be analyzed.
AMPT	Sets the reference level, the displayed dynamic range, the RF attenuation and the unit for the level display. This key is also used to set the level offset and the input impedance.
MKR	Sets and positions the absolute and relative measurement markers (markers and delta markers). In addition, the following measurement functions are assigned under this key: <ul style="list-style-type: none"> • Frequency counter (<i>SIGNAL COUNT</i>) • Fixed reference point for relative measurement markers (<i>REFERENCE FIXED</i>) • Enlargement of the measurement area (<i>MARKER ZOOM</i>)
MKR->	Used for search functions of the measurement markers (maximum/minimum of the trace). Assigns the marker frequency to the center frequency, and the marker level to the reference level. Restricts the search area (<i>SEARCH LIMITS</i>) and characterizes the maximum points and minimum points (<i>PEAK EXCURSION</i>).
MKR FCTN	Provides additional analysis functions of the measurement markers: <ul style="list-style-type: none"> • Noise marker (<i>NOISE MEAS</i>) • Phase noise (<i>PHASE NOISE</i>) • n dB down function • AM/FM audio demodulation (with option R&S FSP-B3) • Peak list
BW	Sets resolution bandwidth, video bandwidth and the two ratios "resolution bandwidth/video bandwidth" and "span/resolution bandwidth" in the case of automatic coupling.
SWEEP	Sets the sweep time and the number of measurement points. Selects continuous measurement or single measurement.

Function Keys on the Front Panel

Function key	Assigned functions
MEAS	Used to perform complex measurement functions: <ul style="list-style-type: none"> • Measurement of time domain power (<i>TIME DOM POWER</i>) • Measurement of channel and adjacent channel power (<i>CHAN PWR ACP</i>) • Measurement of multicarrier adjacent channel power (<i>MULT CARR ACP</i>) • Occupied bandwidth (<i>OCCUPIED BANDWIDTH</i>) • Signal statistics (<i>SIGNAL STATISTIC</i>): amplitude probability distribution (APD) and cumulative complementary distribution function (CCDF) • Carrier to noise spacing (<i>C/N C/No</i>) • AM modulation depth (<i>MODULATION DEPTH</i>) • Spurious emissions (<i>SPURIOUS EMISSIONS</i>) • Third-order intercept point (<i>TOI</i>)
TRIG	Sets trigger source, trigger threshold, trigger delay, and gate configuration in the case of gated sweep.
TRACE	Configures measured data acquisition (<i>CLR/WRITE</i> ; <i>AVERAGE</i> , <i>MAXHOLD</i> ; <i>MINHOLD</i> , <i>VIEW</i>). Configures the analysis of the measurement data (<i>DETECTOR</i>) and the mathematical linking of traces (<i>TRACE MATH</i>).
LINES	Configures display lines and limit lines.
DISP	Configures the screen layout (one/two diagrams) and the diagram contents. This key can also be used to configure the screen colors.
FILE	Provides the functions for storing/loading instrument settings and for managing stored files.
CAL	Used to perform instrument self-calibration.
SETUP	Used to set or display the following the default settings of the instrument: <ul style="list-style-type: none"> • Reference frequency, noise source, preamplifier, level correction values (<i>TRANSDUCER</i>), date, time, GPIB, RS-232-C interface, LAN interface • Firmware update and enabling of options • Information about instrument configuration (<i>SYSTEM INFO</i>) incl. firmware version, module data and system error messages • Service support functions
HCOPY	Configures the screen printout, and selects and configures the printer.

1.3 Front Panel Connections

This section describes the front connectors and interfaces of the R&S FSP. Optional connectors and interfaces are indicated by the option name in brackets.

RF INPUT

The RF input is to be connected to the DUT via a cable equipped with an appropriate connector. Be sure not to overload the input. The maximum continuous power at the RF input is +30 dBm (1 W).

NOTICE

For R&S FSP devices with an upper frequency limit of 8 GHz or less, the RF input is AC-coupled. For all other R&S FSP devices (upper frequency limit > 8 GHz), the RF input is DC-coupled.

For AC-coupling, a DC input voltage of 50 V must never be exceeded. For DC-coupling, DC voltage must not be applied at the input.

In both cases, noncompliance will destroy the input mixers.

Connections for External Mixers (*EXT MIXER*, Option *R&S FSP-B21*)

External mixers can be connected at the LO OUT/IF IN and IF IN female connectors (option R&S FSP-B21).

Two-port mixers can simply be connected to the LO OUT / IF IN female connector. In the case of three-port mixers, the LO input of the mixer must be connected to the LO OUT / IF IN female connector, and the IF output of the mixer to the IF IN female connector.

Connect the remaining mixer connector to the DUT.

Tracking Generator Output (*GEN OUTPUT 50Ω*, Option *R&S FSP-B9*)

The output of the tracking generator is to be connected to the DUT via a cable equipped with a male N connector.



In the case of DUTs with sensitive HF characteristics with regard to matching (VSWR) at the input, insert a 20 dB attenuator between the DUT and the tracking generator.

The female connector is available only with the tracking generator option (R&S FSP-B9).

AF OUTPUT

Headphones equipped with a miniature jack plug can be connected at the AF OUTPUT female connector.

The internal impedance is 10 Ω . The output voltage can be set by using the volume control to the left of the female connector. If a plug is connected, the internal loudspeaker will automatically be switched off.

The female connector and volume control are available only with the audio demodulator option (R&S FSP-B3).

⚠ CAUTION

Check the volume setting carefully before putting on the headphones in order to protect your hearing.

PROBE POWER

To allow you to connect transducers, the R&S FSP provides two PROBE POWER supply connectors.

The left-hand connector supplies the ± 10 V supply voltages and ground, making it suitable for attaching R&S transducers.

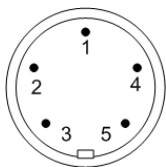

Pin	Signal
1	GND
2	-10 V, max. 200 mA
3	-
4	+10 V, max. 200 mA
5	-

Fig. 1-2 Pin assignments of left-hand PROBE POWER connector

The right-hand connector supplies the +15 V and -12.6 V supply voltages and ground. This connector is suitable for supplying high-impedance probes from Agilent.

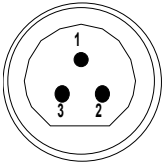

Pin	Signal
1	GND
2	-12.6 V; max. 150 mA
3	+15 V; max. 150 mA

Fig. 1-3 Pin assignments of right-hand PROBE POWER connector

KEYBOARD

The front panel provides a 6-pin PS/2 KEYBOARD female connector for connecting a keyboard.

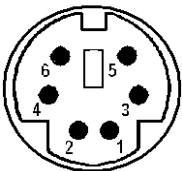

Pin	Signal
1	KEYBOARDDATA
2	MOUSEDATA
3	GND
4	5V, KEYBOARD
5	KEYBOARDCLK
6	MOUSECLK

Fig. 1-4 Pin assignments of the KEYBOARD connection

Disk Drive

The front panel provides a 3.5" disk drive for 1.44 MByte floppy disks.

Removable Hard Disk (CF CARD, Option R&S FSP-B18)

The option R&S FSP-B18 replaces the internal hard disk by a removable compact flash card. The option (see Fig. 1-5) is installed instead of the floppy disk drive. The compact flash card is inserted at the front panel of the instrument. Option R&S FSP-B19 provides a spare hard disk.

NOTICE

To ensure failure-free operation, it is recommended to avoid placing external cables close to the compact flash card.

Switch off the instrument before removing the compact flash card to avoid malfunctions.

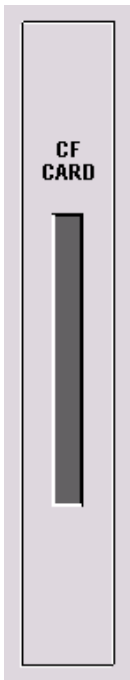

Fig. 1-5 Compact flash card drive, option R&S FSP-B18



In the Windows Explorer, the removable compact flash card is displayed as C: (operating system) and D: (data) drives. The A: drive is still displayed, but is no longer available.

1.4 Rear View

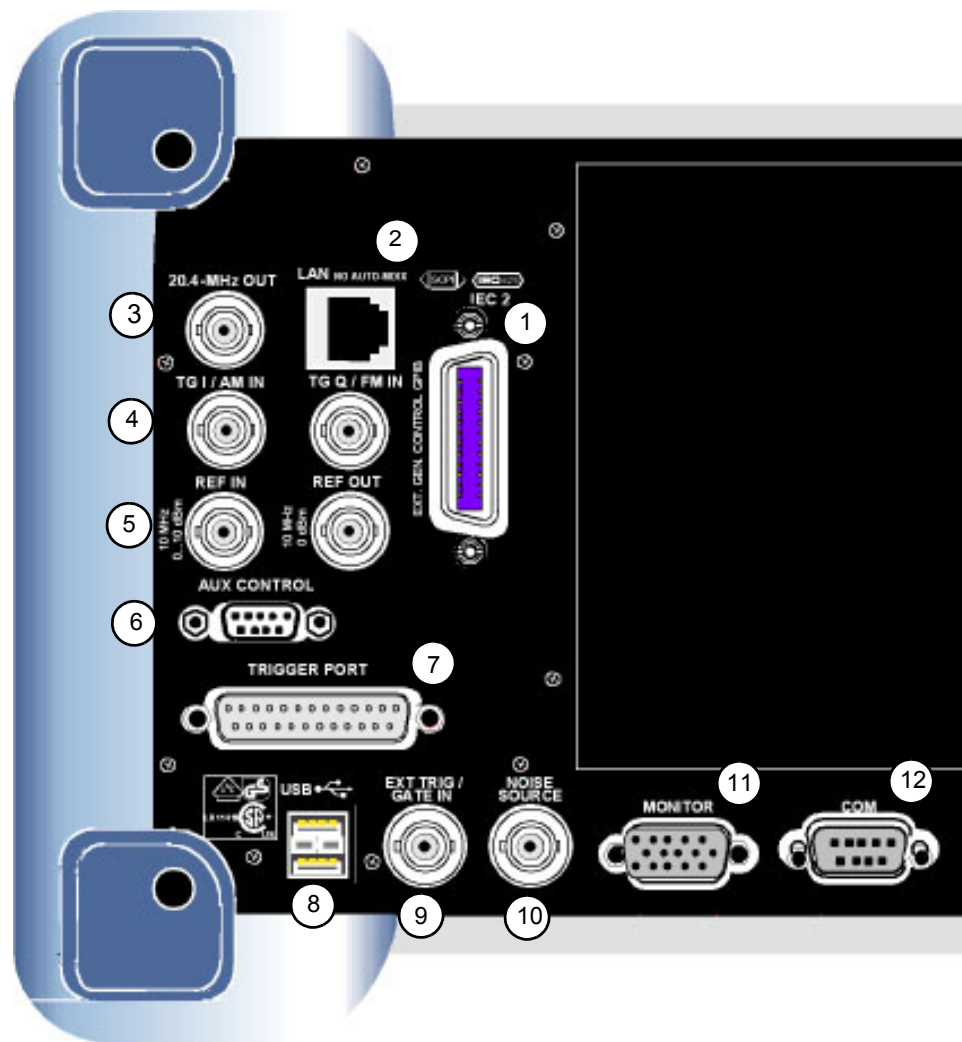
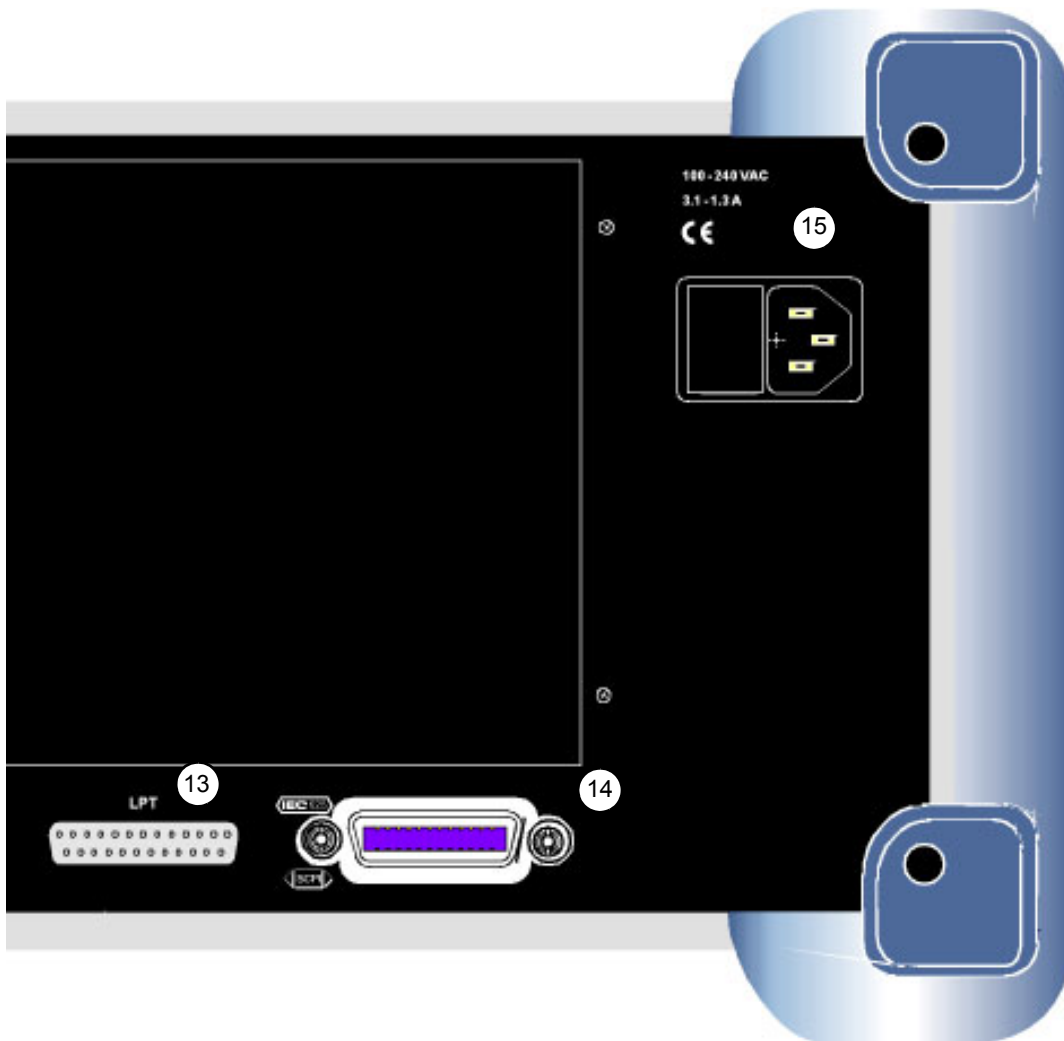

Fig. 1-6 Rear view

Number in Fig. 1-6	Description
1	second GPIB interface for external generator control, option R&S FSP-B10 (see page 16)
2	LAN interface, option R&S FSP-B16 (see page 16)
3	IF output 20.4 MHz (see page 15); with option R&S FSP-B6, this output is replaced by the switchable CCVS input/output (see page 16)
4	I/Q input for tracking generator, option R&S FSP-B9 (see page 16)
5	input/output for external/internal reference (see page 15)
6	external generator control, option R&S FSP-B10 (see page 17)
7	trigger port, option R&S FSP-B28 (see page 14)
8	double USB interface (see page 14)



Number in Fig. 1-6	Description
9	trigger/gate interface (see page 13)
10	noise source supply voltage (see page 13)
11	VGA interface for external monitor (see page 13)
12	RS232-C interface (see page 12)
13	LPT printer interface (see page 12)
14	GPIB interface for remote control (see page 12)
15	AC power supply connector with on/off switch (see page 12)

1.5 Rear Panel Connections

This section describes the rear connectors and interfaces of the R&S FSP. Optional connectors and interfaces are indicated by the option name in brackets.

AC Power Supply Connection and Main Power Switch

An AC power supply connector and main power switch are located in a unit on the rear panel of the instrument.

Main power switch function:

- Position I** After being switched on, the instrument will be either in standby mode or in operation depending on the setting of the ON/STANDBY switch on the front panel of the instrument.
- Position O** Switching the instrument off disconnects the entire instrument from the AC power supply.



The main power switch also interrupts the power supply of the OCXO located in the instrument. When you switch the instrument back on, be sure to comply with the extended warm-up phase specified in the data sheet.

GPIB Interface

The instrument comes with a GPIB interface in compliance with IEEE488. A controller for remote control can be connected via this interface. Use a shielded cable to set up the connection. For further information refer to the Operating Manual, chapter 8.

Printer Interface (LPT)

The 25-pin female LPT connector on the rear panel of the R&S FSP is provided for connecting a printer. The interface is compatible with the CENTRONICS interface. For further information refer to the Operating Manual, chapter 8.

RS-232-C Interface (COM)

The instrument comes with an RS-232-C interface. The interface can be manually activated and configured for remote control by defining the parameters in the *COM INTERFAC* table, which is accessed from the *SETUP - GENERAL SETUP* menu. For further information refer to the Operating Manual, chapter 8.

R&S Monitor Connection (MONITOR)

The 15-pin VGA monitor connection is used to display the screen contents on an external screen. The procedure for putting the external monitor into operation is described in the section “[Connecting an External Monitor](#)” on page 2.12.

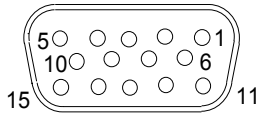

Pin	Signal	Pin	Signal
1	R	9	GND
2	G	10	GND
3	B	11	(NC)
4	(NC)	12	(NC)
5	GND	13	HSYNC
6	GND	14	VSYNC
7	GND	15	(NC)
8	GND		

Fig. 1-7 Pin assignments of the MONITOR connection

Noise Source Control (NOISE SOURCE)

The NOISE SOURCE female connector is used to switch an external noise source on and off in order, for example, to measure the noise figure of DUTs.

Conventional noise sources require a voltage of +28 V in order to be switched on. They are switched off at 0 V. The female connector supplies these switching voltages. The output supports a maximum load of 100 mA.

Input for External Trigger (EXT TRIG/GATE IN)

The EXT TRIG/GATE IN female connector is used to control the measurement by means of an external signal.

The voltage levels are adjustable (0.5 V to 3.5 V). The typical input impedance is 10 k Ω .

USB Interface

The R&S FSP provides a USB female connector at the rear panel for connecting two USB devices (upper connector USB 1.1, lower connector USB 2.0).

NOTICE

Use suitable double shielded cables. Passive USB connecting cables must not exceed 1 m in length.

Use only USB devices that keep the permissible EMI limits.

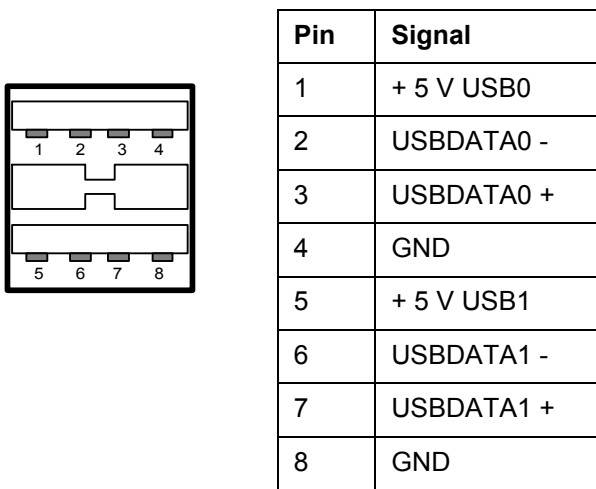
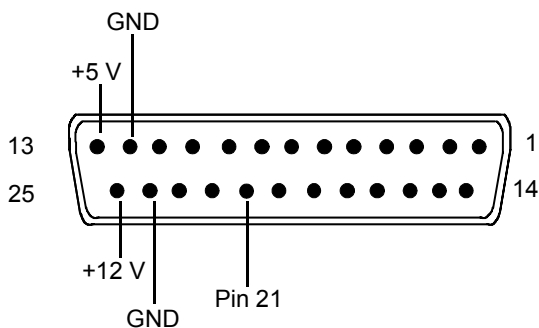

Fig. 1-8 USB connector assignment

Trigger Port (Option R&S FSP-B28)

The 25-pin trigger port female connector (option R&S FSP-B28) provides a signal at pin 21 that signals that the instrument is ready to receive a trigger pulse. This signal takes into consideration the instrument's internal waiting and settling times.



Pin	Signal	Range of values
1 to 11	not used	
12	ground	
13	+5 V supply voltage	5.2 V \pm 0.5 V, max. 30 mA
14 to 20	reserved	
21	ready-for-trigger output signal	HIGH: \geq 1.4 V, LOW: \leq 0.7 V
22 to 23	not used	
24	ground	
25	+12 V supply voltage	+12 V \pm 0.5 V, max. 10 mA

Reference Input and Output (REF IN and REF OUT)

The REF IN female connector is used as an input for a 10 MHz reference signal. The required input level is 0 to 10 dBm. The REF OUT female connector provides the internal 10 MHz reference signal with a 0 dBm output level for other devices.

The *SETUP* menu is used to select between the internal and external references.

If an external reference is used for operation, the external reference signal from REF IN is looped through to REF OUT.

NOTICE

Use suitable double shielded cables.

20.4 MHz IF Output

The 20.4 MHz IF signal of the R&S FSP is provided at the 20.4 MHz OUT female BNC connector. For resolution bandwidths between 100 kHz and 10 MHz, the bandwidth corresponds to the selected bandwidth. For bandwidths \leq 100 kHz, the bandwidth of the output is equal to 2.6 * resolution bandwidth, where the minimum value is 2.6 kHz (non-FFT). In the analyzer mode, the level at the IF output in the case of a signal at the reference level is 0 dBm if the resolution bandwidth is \geq 100 kHz; if the resolution bandwidth is $<$ 100 kHz, the level is -10 dBm (for mixer levels \geq -60 dBm).

NOTICE

Use suitable double shielded cables.



With option R&S FSP-B6, this output is replaced by the CCVS IN/ OUT connector.

CCVS Output and Input (CCVS IN/OUT, Option R&S FSP-B6)

The CCVS IN/OUT female BNC connector is a switchable CCVS input/output. If TV triggering is activated and triggering occurs in response to the internal demodulator signal (CCVS INT), the demodulated TV signal is provided for operating an CCVS monitors. If triggering occurs in response to an externally supplied CCVS signal (CCVS EXT), the female connector serves as an input.

TG I / AM IN; TG Q / FM IN (Option R&S FSP-B9)

The two female connectors TG I /AM IN and TG Q /FM IN are used to modulate the tracking generator (option R&S FSP-B9) by means of an external signal.

The input voltage range is ± 0.5 V; the input impedance is 50 Ω .

LAN Interface (Option R&S FSP-B16)

The LAN interface can be used to connect to a local network. The assignment of the RJ-45 connector supports twisted-pair category 5 UTP/STP cables in a star configuration (UTP stands for “unshielded twisted pair”, and STP for “shielded twisted pair”).

Second GPIB Interface IEC2 (Option R&S FSP-B10)

When equipped with option R&S FSP-B10 (external generator control), the instrument provides a second GPIB interface for using external generators.

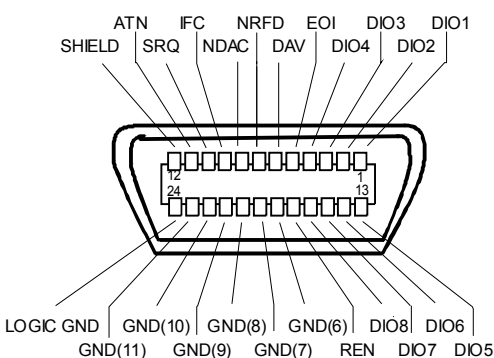

Fig. 1-9 Pin assignment of the second IEC interface



The R&S FSP remote control is not supported via the second GPIB interface.

AUX CONTROL (Option R&S FSP-B10)

If option R&S FSP-B10 (external generator control) is built in, the R&S FSP provides a female connector that allows measurement data acquisition to be synchronized with the output signal of a Rohde & Schwarz generator.

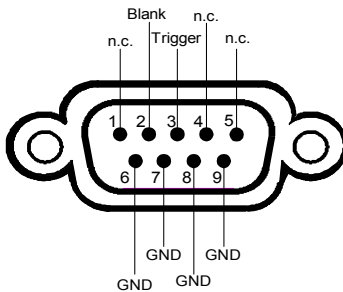

Pin	Signal	Description
1	n.c.	not connected
2	BLANK	Return signalling from the signal generator indicating that frequency setting is completed
3	TRIGGER	Trigger signal for switching to the next frequency
6...9	GND	Ground

Fig. 1-10 Pin assignment of the AUX CONTROL connector

2 Preparing for Use

2.1 Preparing for Operation	2.4
2.1.1 Unpacking the Instrument	2.4
2.1.2 Setting Up the Instrument	2.4
2.1.3 Installation in a 19" Rack	2.5
2.1.4 Connecting the Instrument to the AC Power Supply	2.6
2.1.5 Switching On the R&S FSP	2.6
2.1.6 Functional Test	2.6
2.1.7 Switching Off the R&S FSP	2.7
2.1.8 Cleaning the Outside	2.8
2.2 Instrument Drive Usage	2.8
2.3 Connecting External Devices	2.9
2.3.1 Connecting an External Keyboard	2.9
2.3.2 Connecting a Mouse	2.11
2.3.3 Connecting an External Monitor	2.12
2.3.4 Connecting a Printer	2.13
2.3.5 Connecting USB Devices (e.g. a Power Meter)	2.13

2.3.6	Connecting External Generators	2.15
2.3.6.1	Connecting the R&S FSP to the Generator	2.16
2.3.6.2	Configuring the Generator on the R&S FSP	2.16
2.3.6.3	Activating the Generator Configuration and Setting the Output Level	2.17
2.3.6.4	Using an External Generator as a Tracking Generator	2.18
2.4	Setup	2.19
2.4.1	Selecting the Frequency Reference	2.19
2.4.2	Setting the Date and Time	2.19
2.4.3	Setting the GPIB Interface	2.20
2.4.3.1	GPIB Address	2.20
2.4.3.2	GPIB Language	2.21
2.4.3.3	ID Response String	2.22
2.4.4	Setting the Screen Colors	2.23
2.4.5	Automatically Switching Off the Internal Screen	2.24
2.4.6	File and Path Selection Using the Front Panel Keys	2.25
2.4.7	Selecting and Configuring Printers	2.27
2.4.7.1	Selecting Alternative Printer Configurations	2.28
2.4.7.2	Selecting Printer Colors	2.28
2.4.8	Installing Plug&Play Printers	2.29
2.4.9	Installing Non-Plug&Play Printers	2.30
2.5	Configuring the LAN Interface (Option R&S FSP-B16 only)	2.30
2.5.1	Connecting the Instrument to the Network	2.30
2.5.2	Configuring the Network Card	2.30
2.5.2.1	Driver Installation	2.30
2.5.2.2	Configuring the Interface	2.31
2.5.2.3	Configuring Existing Network Protocols (TCP/IP Protocol)	2.31
2.5.2.4	Installing Additional Network Protocols and Services	2.35
2.5.3	Login	2.35
2.6	LXI Configuration	2.36
2.6.1	LXI Configuration Dialog	2.37
2.6.2	LXI Browser Interface	2.37

2.6.3 LAN Configuration website	2.38
2.6.4 Ping	2.38
2.7 Operating System Properties	2.39
2.7.1 Properties Specific to Windows XP	2.39
2.7.1.1 Windows XP Service Packs	2.39
2.7.1.2 Opening the Windows XP Start Menu	2.40
2.7.1.3 Windows XP Software Approved for the Instrument	2.40

2.1 Preparing for Operation

This section describes how to put the instrument into operation.

NOTICE

Before putting the instrument into operation, make sure that the following requirements have been met:

- The air vents are not blocked.
- No signal voltage levels exceeding the permitted limits are present at the inputs.
- The instrument's outputs are neither overloaded nor incorrectly connected.

Not complying with these requirements can result in damage to the instrument.

2.1.1 Unpacking the Instrument

- Remove the instrument from its packaging and check the equipment for completeness using the delivery note and the accessory lists for the various items.
- First, pull off the polyethylene protection pads from the instrument's rear feet and then carefully remove the pads from the instrument handles at the front.
- Pull off the corrugated cardboard cover that protects the rear of the instrument.
- Carefully unthread the corrugated cardboard cover at the front that protects the instrument handles and remove it.
- Check the instrument for any damage. If there is damage, immediately contact the carrier who delivered the instrument. In this case, make sure not to discard the box and packing material.

It is advisable to keep the original packing material in order to prevent control elements and connectors from being damaged in case the instrument is to be transported or shipped at a later date.

Protective plastic caps for the front panel and the rear panel can be ordered additionally (order number 1096.7095.00). Please note that you need to order 2 covers for 1 instrument.

2.1.2 Setting Up the Instrument

The instrument is intended for indoor use. Note the following in this regard:

- The ambient temperature must comply with the range specified in the data sheet.
- Air inflow and outflow via the air vents on the rear panel and through the lateral perforations must not be obstructed. Clearance from walls must be at least 10 cm.
- The mounting surface must be even.

NOTICE**Risk of damaging electronic components**

To avoid damage of electronic components, the operational site must be protected against electrostatic discharge (ESD).

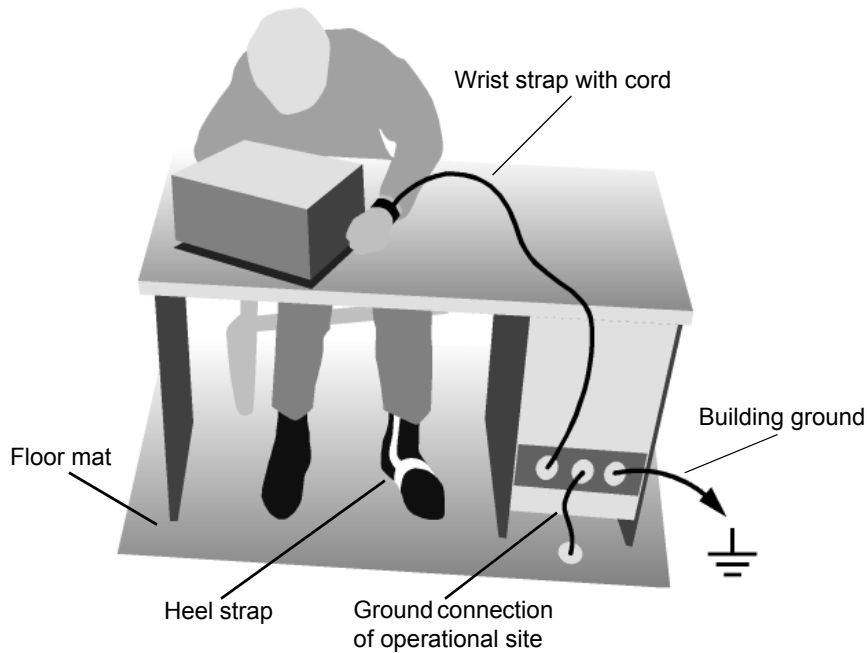

The following two methods of ESD protection may be used together or separately:

- Wrist strap with cord to ground connection
- Conductive floor mat and heel strap combination

2.1.3 Installation in a 19" Rack

The instrument can be installed in a 19" rack by using a rack adapter (see data sheet for order number). The installation instructions are included with the adapter.

NOTICE

When the instrument is installed in a rack, make sure that the vents for air inflow on the side panel and the air outlets on the rear panel are not obstructed.

2.1.4 Connecting the Instrument to the AC Power Supply

The R&S FSP is equipped with a mechanism for detecting AC power voltage and automatically sets itself to use the available AC power voltage (range: AC voltage 100 V to 240 V; 50 Hz to 400 Hz). The AC power connector is located on the rear panel of the instrument.

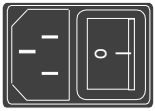

AC power connector

- Connect the R&S FSP to the AC power supply, using the power cable that is supplied.

Since the instrument is assembled in line with the specifications for safety class EN61010, it may only be connected to an outlet that has a ground contact.

2.1.5 Switching On the R&S FSP

- Press the power switch on the rear panel to change it to position I.
- Press the ON/STANDBY key on the front panel. The green LED will light up.

NOTICE

Do not switch off the instrument while it is booting.
Switching it off prematurely can lead to serious data changes on the instrument's hard disk.

After being switched on, the R&S FSP displays the following information:

```
Rohde & Schwarz GmbH & Co. KG
Analyzer BIOS      Vx.y
```

A self test of the computer hardware will be carried out. Windows XP then starts, and the measurement screen will automatically appear with the settings that were present when the instrument was last switched off.



If you want the instrument to automatically load different settings when it is switched on, define the required configuration in the *FILE - STARTUP RECALL* menu.

2.1.6 Functional Test



The functional test should only be performed when the operating temperature is reached (approx. 15 minutes after the instrument is switched on).

- Call self alignment with the *CAL* key, *CAL TOTAL* softkey. Once the system correction values have been calculated successfully, the message *Calibration Passed* will appear.

Preparing for Operation

- Start the self test with the *SETUP* key, *SERVICE – SELFTEST* softkeys. Once the instrument modules have been checked successfully, the message *Selftest Passed* will appear.

Once both steps have been completed successfully, the instrument will be ready for operation.



The self alignment does not need to be repeated every time the instrument is switched on, because the instrument saves the values and loads them during booting automatically. A self alignment is recommended if the instrument is used at a temperature that differs considerable (more than 10°C) from the temperature present at the last self alignment.

The self test also does not need to be repeated every time the instrument is switched on. It is necessary only when instrument malfunction is suspected.

2.1.7 Switching Off the R&S FSP

- Press the ON/STANDBY key on the front panel.

The R&S FSP will store the current settings on the hard disk and then shut down the software. Once the operation has been completed, the power supply unit will be switched to STANDBY and the yellow LED will come on.

WARNING

Shock hazard

In standby mode, the AC supply voltage is still present on the instrument.

- To completely disconnect the instrument from the AC power supply, change the power switch on the rear panel to position O.



- The main power switch on the rear panel also interrupts the power supply of the OCXO (optional) inside the instrument. When you switch the instrument back on, be sure to adhere to the extended warm-up phase.
- If you switch off the instrument by using the power switch or by disconnecting the power supply connector, it is not possible to save the current instrument settings on the hard disk. In this case, the last settings that were stored on the hard disk will be loaded when you switch the instrument back on.

2.1.8 Cleaning the Outside

The outside of the instrument is suitably cleaned using a soft, line-free dust cloth. Make sure that the air vents are not obstructed.

NOTICE

Cleaning agents contain substances that may damage the instrument, e.g. solvent-containing cleaning agents may damage the front panel labeling or plastic parts.

Never use cleaning agents such as solvents (thinners, acetone, etc.), acids, bases, or other substances.

2.2 Instrument Drive Usage

The harddisk space is divided in 3 logical drives.

C:

Contains the operating system Windows XP, printer driver, network driver,...

Other user programs, applications, driver should be stored/installed on drive C:.

D:

Contains instrument's firmware and related data sets (limit lines, transducers,...)

D:\user\config is the default location for customized instrument settings

D:\R_S\instr\temp is the default directory for hardcopy files.

Other user data should be stored on drive D:.

E:

Backup storage location for Windows XP. Here a copy of the operating system is saved.

This drive is used to restore Windows XP using "Analyzer Firmware Backup" function on Power On. A copy of the currently installed update sets are located on this drive, too.

No additional data should be stored on this drive.

2.3 Connecting External Devices

2.3.1 Connecting an External Keyboard

NOTICE

Do not connect the keyboard unless the instrument is switched off (STANDBY). Otherwise, proper functioning cannot be ensured due to interactions with the firmware.

An external PC keyboard can be connected to the 6-pin PS/2 KEYBOARD connector on the front panel of the R&S FSP or to the USB interface on the rear panel.



The keyboard simplifies instrument operation and the entry of comments, file names, etc.

Keyboards and mouse devices conform to USB Standards 1.1 or 2.0 are suitable for connection to the USB interface.

After being connected, the keyboard is automatically detected. The default keyboard language setting is US English. Special settings such as refresh rate, etc. can be made in the Windows XP Start menu by selecting *START - SETTINGS - CONTROL PANEL - KEYBOARD*.

International Keyboard Support

As of firmware version 4.3x, the following international keyboard drivers are supported.

- French Keyboards
- German Keyboards
- Italian Keyboards
- Portuguese Keyboards
- Spanish Keyboards

These drivers are already installed on the R&S FSP, if it is shipped with firmware version 4.3x or later. A separate installer file is available on the [R&S FSP internet site](#).

To change the keyboard driver language proceed as follows:

1. Start Windows Explorer
2. Start the installation procedure with double click onto the file *FsxInternationalKeyboards.msi*.
3. Reboot the analyzer.
4. Now open the windows start menu by pressing the windows key or <CTRL> <ESC>.

5. Select *Settings - Control Panel - Regional and Language Options - Languages*.

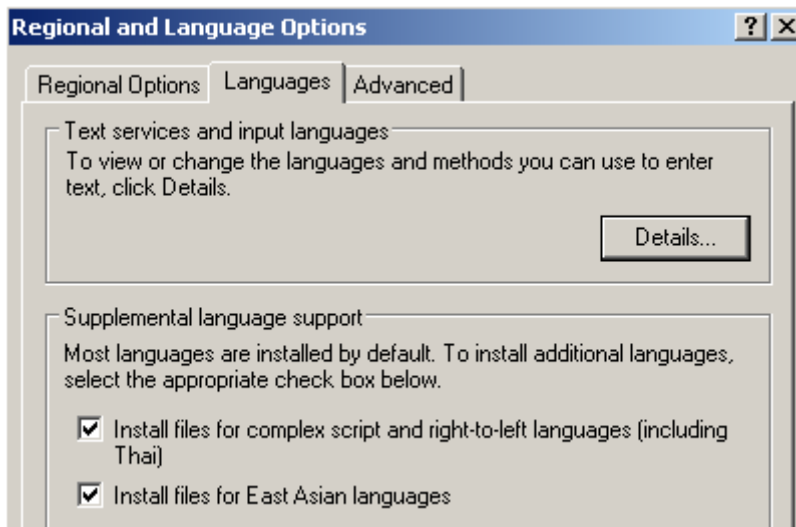

6. Select *Details*

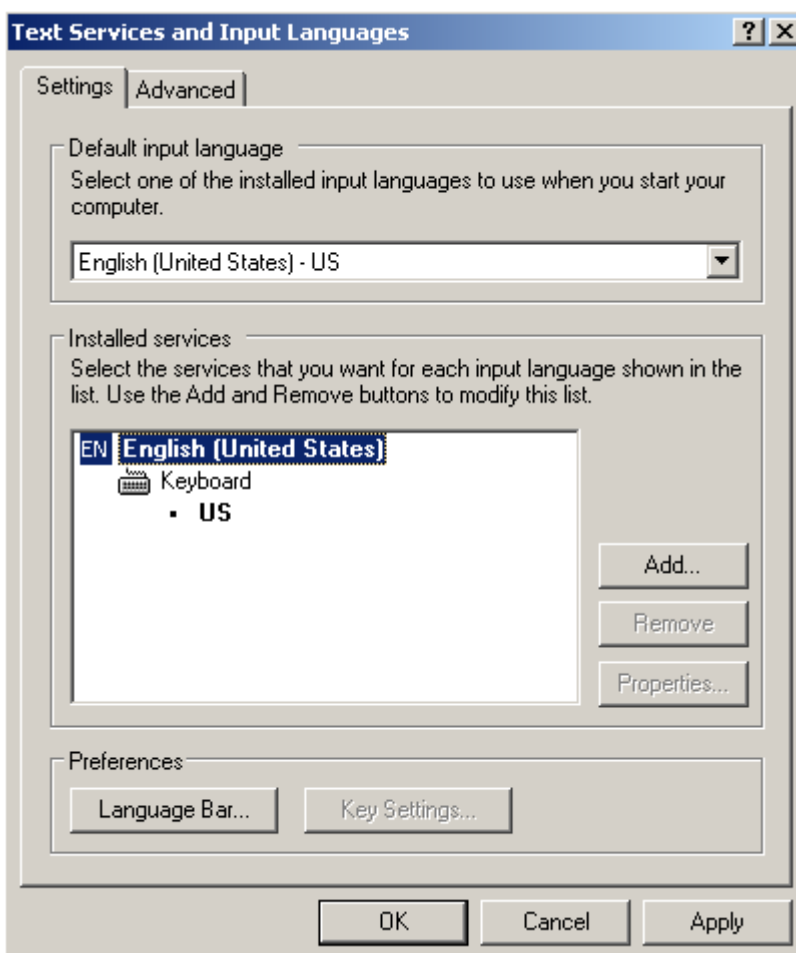

7. Select *Add* and choose one of the available languages.
Confirm your selection with OK.

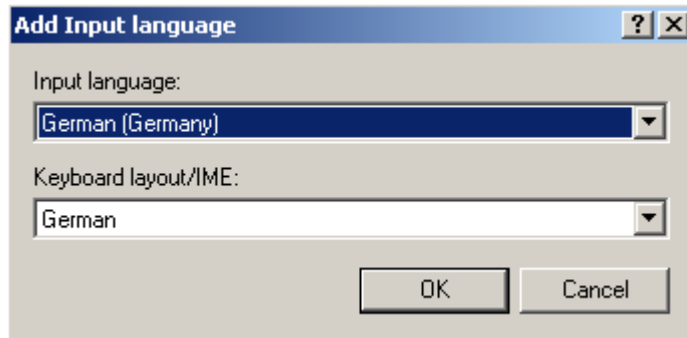

8. Change the Default input language as you like in the *Default Input Language* pane and close all open dialogs with OK.
9. Reboot the R&S FSP

2.3.2 Connecting a Mouse

To simplify Windows XP operation, the R&S FSP allows you to connect a mouse to the USB interface on the rear panel.

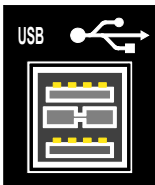

Mouse devices from Microsoft and Logitech are supported.



If you use a keyboard that contains a trackball for mouse operations, connecting an external mouse in addition may lead to malfunctions.

After being connected, the mouse is automatically detected. Special settings such as mouse cursor speed, etc. can be made in the Windows XP Start menu by selecting *START - SETTINGS - CONTROL PANEL - MOUSE*.

2.3.3 Connecting an External Monitor

NOTICE

Do not connect a monitor unless the instrument is switched off (STANDBY). Otherwise, you run the risk of damaging the monitor.

You can connect an external monitor at the MONITOR connector on the instrument's rear panel.

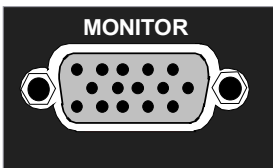

After connecting the external monitor, restart the instrument to detect the monitor. The measurement display will then appear on both the external screen and on the instrument. No further settings are necessary.

If the external monitor is not recognized by the instrument, you have to activate it. This requires a mouse and an external keyboard (the connection is described in sections “[Connecting a Mouse](#)” on page 2.11 and “[Connecting an External Keyboard](#)” on page 2.9).

- Make sure that the external monitor is connected.
- Press the *CTRL+ESC* key combination to display the taskbar.
- On the right side of the taskbar, click the monitor icon.
- Select *Graphics Options - Output To - Intel(R) Dual Display Clone - Monitor + Digital Display*.

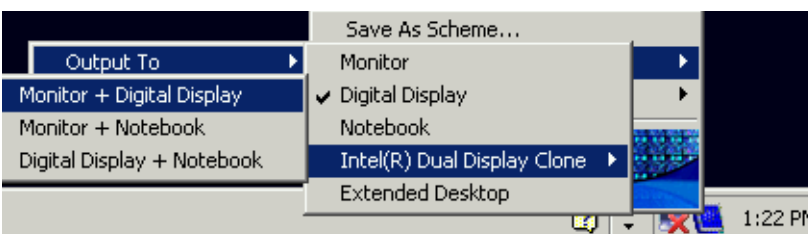
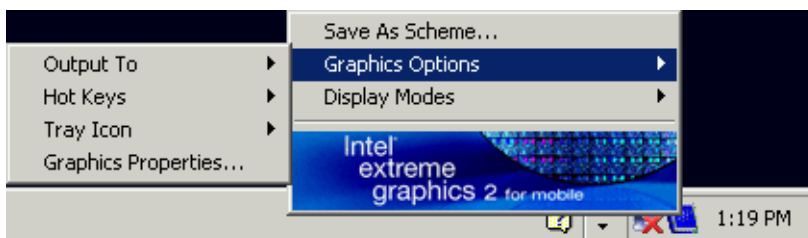

When the instrument is switched on later without a monitor, the activation of the external monitor is reset.

2.3.4 Connecting a Printer

A printer can be connected during operation.

The R&S FSP allows you to create two different printer configurations for printing out a hardcopy of the screen and you can toggle between them by pressing a button. The *DEVICES* table in the *HCOPY* menu lists the available installed printers.

The LPT printer interface is located on the rear panel. Alternatively, one of the USB interfaces on the front or rear panel can be used.

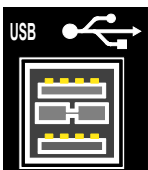
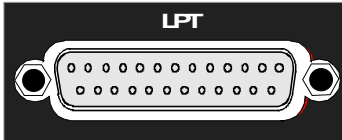

2.3.5 Connecting USB Devices (e.g. a Power Meter)

The USB interface on the rear panel of the R&S FSP allows you to connect up to two USB devices directly to the R&S FSP. This number can be increased as necessary by inserting USB hubs.

Due to the large number of available USB devices, there is almost no limit to the expansions that are possible with the R&S FSP. The following list shows various USB devices that can be useful for the R&S FSP:

- Power sensors of the R&S NRP-Zxx series (require adapter cable R&S NRP-Z4)
- Memory stick for easy transfer of data to/from a PC (e.g. firmware updates)
- CD-ROM drives for easy installation of firmware applications
- PC keyboard for entering comments, file names, etc.
- Mouse for easy operation of Windows XP dialog boxes
- Printer for printing out measurement results
- Modem for remote control of the R&S FSP over large distances

Installing USB devices is easy under Windows XP, because all USB devices are plug&play. All USB devices can be connected to or disconnected from the R&S FSP during operation.

After a device is connected to the USB interface of the R&S FSP, Windows XP automatically searches for a suitable device driver.

If Windows XP does not find a suitable driver, it will prompt you to specify a directory that contains the driver software. If the driver software is on a CD, connect a USB CD-ROM drive to the R&S FSP before proceeding.

When a USB device is subsequently disconnected from the R&S FSP, Windows XP immediately detects the change in hardware configuration and deactivates the corresponding driver.

Example:

Connect a memory stick to the R&S FSP:

1. When you connect the pendrive at the USB interface, Windows XP detects the new hardware:

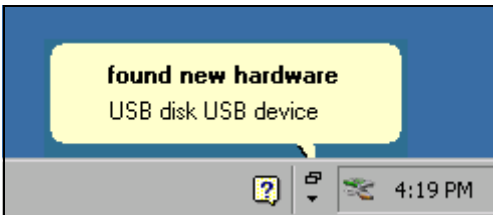

2. Windows XP installs the corresponding driver.

If installation is successful, Windows XP informs you that the device is ready to use:

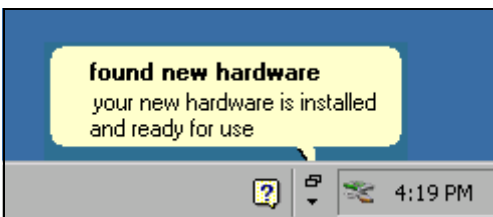

The memory stick is made available as a new drive and is displayed in the Windows Explorer:

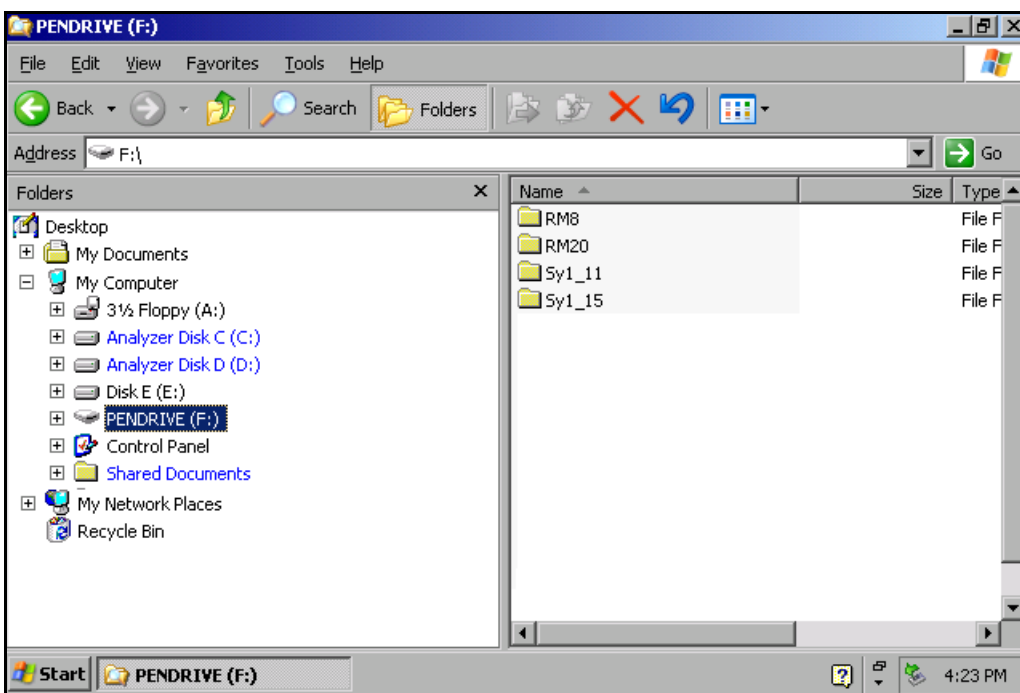

The memory stick can be used like a normal drive to load or store data.

Connecting External Devices

- If you no longer need the memory stick or if you want to transfer files to another computer, simply disconnect the memory stick. Windows XP will automatically deactivate the driver. If the drive is still selected in Explorer, an error message will appear indicating that the drive is no longer available.

2.3.6 Connecting External Generators

The External Generator Control option (R&S FSP-B10) allows you to operate a number of commercially available generators as a tracking generator on the R&S FSP. When suitable generators are used, the R&S FSP thus allows scalar network analysis to be performed also outside the frequency range of the internal tracking generator. Appendix [“External Generator Control”](#) provides a list of generators supported by the option R&S FSP-B10.

The following figure shows the test setup:

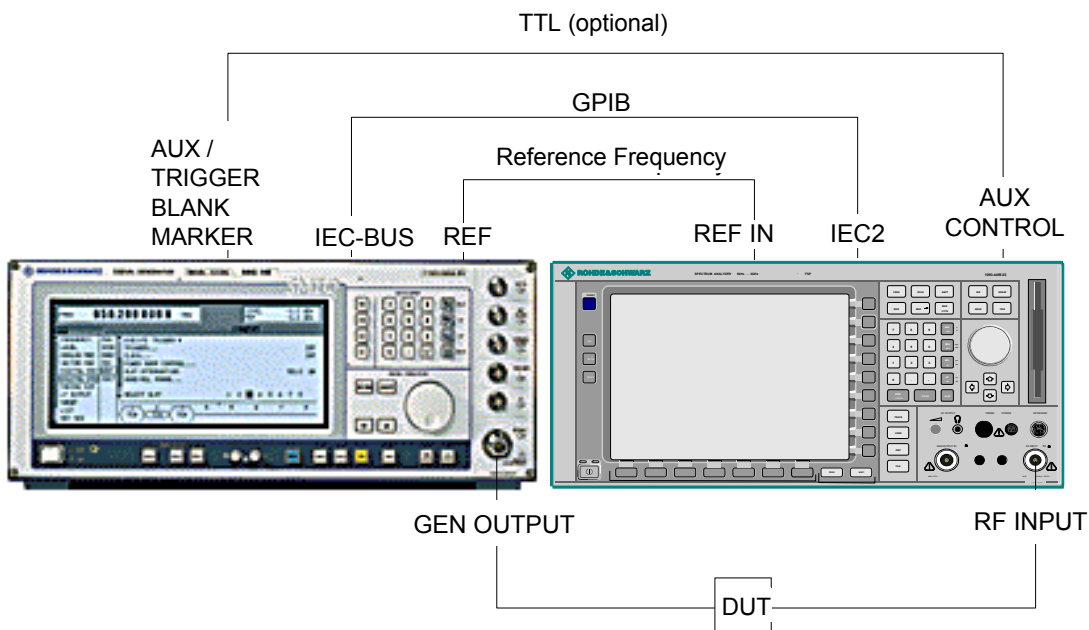

The generator is controlled via the – optional – second GPIB interface of the R&S FSP (= IEC2, supplied together with the option). With some Rohde & Schwarz generators, it is also controlled via the TTL synchronization interface that is contained in the AUX CONTROL interface of the R&S FSP.



- Using the TTL interface allows you to attain significantly higher speeds than possible with a pure GPIB control, because the frequency switching mechanism of the R&S FSP is directly coupled to the frequency switching mechanism of the generator.
- To increase measurement accuracy, use a shared reference frequency to operate the R&S FSP and the generator. If no independent 10 MHz reference frequency is available, connect the reference output of the generator to the reference input of the R&S FSP and use *SETUP – REFERENCE EXT* to configure the R&S FSP to implement the external reference.

2.3.6.1 Connecting the R&S FSP to the Generator

To couple the frequency setting and level setting of the generator to the R&S FSP, set up the following connections:

1. Connect the GPIB interface of the generator to the IEC2 connector on the rear panel of the R&S FSP.
2. (Optional:) Connect the TTL interface of the generator and the R&S FSP.
 - Alternative 1 (R&S SMR, R&S SMU):
Connect the AUX CONTROL connector of the R&S FSP to the corresponding AUX connector on the rear panel of the generator (the connection cable is supplied together with the option R&S FSP-B10).
 - Alternative 2 (R&S SME, R&S SMP, R&S SMIQ):
Connect the AUX CONTROL connector of the R&S FSP to the TRIGGER, MARKER and BLANK connectors on the rear panel of the generator (the connection cable is also supplied together with the option R&S FSP-B10). Note the labelling on the TRIGGER, MARKER and BLANK lines.
 - Alternative 3 (R&S SML, R&S SMG/SMGU, R&S SMH/SMHU, R&S SMX/SMY, generators from other manufacturers):
No TTL connection possible.

The generator type determines which one of the possible connections is suitable for the generator. For more information, refer to the Operating Manual for the generator.

3. Connect the reference frequency output of the generator to the reference frequency input (*REF IN*) of the R&S FSP.
or
Connect the reference frequency inputs of the two instruments to an external frequency standard.

2.3.6.2 Configuring the Generator on the R&S FSP

To configure the generator, press the *NETWORK* hotkey located in the hotkey bar at the lower edge of the screen.

SPECTRUM

NETWORK



SCREEN B

Perform the following steps:

1. Press the *EXT SOURCE* softkey. The submenu for configuring generators will open
2. Select and configure the generator:
 - Press the *SELECT GENERATOR* softkey.
The table containing the generator settings will open. The selection bar will be located in the row *SRC 1* under the column *TYPE*.

SELECT GENERATOR									
SRC	TYPE	IFC	GPIB ADDR	MODE	F MIN	F MAX	P MIN	P MAX	
1	SME03	TTL	28	REMOTE	5kHz	3GHz	-144dBm	16dBm	
2	SMIQ03	GPIB	28	LOCAL	300kHz	3.3GHz	-140dBm	13dBm	

Connecting External Devices

- Press the *ENTER* key.
The list of available generators will open.
- Using the rotary knob, select the desired generator and activate *ENTER* by pressing the rotary knob.
The generator list will close, and the selected generator will then appear in the *SELECT GENERATOR* table. Simultaneously, the limits for frequency and output power which you can set on the generator will appear in the F MIN, F MAX, P MIN and P MAX fields.
- Using the  key, move the selection bar to the IFC column and press the *ENTER* key.
The list of available control interfaces will appear.
- If the TTL interfaces from the R&S FSP and generator are connected, select *TTL* by using the rotary knob and then activate it by pressing the rotary knob.
- If no TTL interface is provided or if the TTL interfaces are not connected, select *GPIB* by using the rotary knob and then activate it by pressing the rotary knob.
- Using the  key, move the selection bar to the GPIB ADDR column and press the *ENTER* key.
The entry field for the GPIB address of the generator will open.
- Enter the GPIB address of the generator and confirm with *ENTER*.
The specified address will be added to the table.

3. Select the reference frequency for the generator:

- If you want to operate the generator using its internal reference, change the *GEN REF* softkey to the state *INT*.
- If you want to operate the generator using an external reference, change the *GEN REF* softkey to the state *EXT*.

This concludes the procedure for defining the default setting for the generator.



A second generator configuration can be inserted in advance by repeating the settings in the line SRC 2. This makes it easy to switch from one generator type to another.



2.3.6.3 Activating the Generator Configuration and Setting the Output Level

To select the active generator configuration, press the *FREQUENCY SWEEP* softkey. The *FREQUENCY SWEEP* table will open, and the selection bar will be located under the *STATE* column in the *SRC 1* row.

FREQUENCY SWEEP						
SOURCE FREQ = REC FREQ * NUM/DEN + OFFSET						
SRC	STATE	POWER[dBm]	NUM	DEN	OFFSET	RESULT
1	<input checked="" type="checkbox"/>	-30dBm	1	1	0Hz	0Hz..3GHz *
2	<input type="checkbox"/>	-30dBm	1	1	0Hz	0Hz..3.2GHz

- If you want to use the *SRC 1* generator configuration, insert a checkmark in the field by pressing the *ENTER* key.

Connecting External Devices

- If you want to use the *SRC 2* generator configuration, move the selection bar to the lower line of the table by using the  key. Then activate the generator configuration by pressing the *ENTER* key and set the checkmark in line 2 under the *STATE* column.
- Using the  key, move the selection bar to the *POWER [dBm]* column and press the *ENTER* key.
- Enter the desired output power and confirm with the *dBm* key. The power you entered will appear in the table.



You can also change the output power of the generator by using the *SOURCE POWER* softkey located in the *NETWORK* menu.

The remaining columns of the table are used to configure frequency-converting measurements. For more information, refer to the Operating Manual, section "External Generator Control - Option R&S FSP-B10".

This concludes the procedure for configuring the generator.

2.3.6.4 Using an External Generator as a Tracking Generator

To activate the external generator as a tracking generator, do the following:

- Switch on the external generator.
- Press the *NETWORK* hotkey on the R&S FSP.
- Press the *EXT SOURCE* softkey.

Tracking generator operation using an external generator will be activated. The external generator will switch to remote control and can be used like an internal tracking generator. For more information about measurements with an external tracking generator, refer to the Operating Manual, section "External Generator Control - Option R&S FSP-B10".

Switching off the tracking generator:

- Press the *NETWORK* hotkey on the R&S FSP.
- Press the *EXT SOURCE* softkey.
- Change the *EXT SRC* softkey to *OFF* by pressing it.



When you switch off tracking generator operation using an external generator, control on the IEC2 is automatically released and the generator is returned to *LOCAL* mode.

2.4 Setup

2.4.1 Selecting the Frequency Reference

You can switch the reference signal for frequency processing of the R&S FSP between the internal reference and an external reference signal at 10 MHz as follows:

- Press the *SETUP* key.
The *SETUP* menu will open.
- Press the *REFERENCE INT/EXT* softkey until it is in the desired state.



If the reference signal is missing when switchover to the external reference occurs, *EXREF* is displayed after a few moments, indicating that synchronization has not taken place.

When switchover to an internal reference occurs, note that the external reference signal is removed in order to avoid any interactions with the internal reference signal.

IEC bus command: `ROSC:SOUR INT`

2.4.2 Setting the Date and Time

- Press the *SETUP* key.
The *SETUP* menu will open.
- Press the *GENERAL SETUP* softkey.
The submenu with general settings will open.

The *TIME+DATE* softkey activates the *TIME AND DATE* table for entering the time and date for the internal real-time clock.

TIME AND DATE	
Time	12 : 30
Date	11 MAR 2008

Entering the time

Hours and minutes can be entered independently of each other in the entry field:

TIME	
TIME	12 : 30

IEC bus command: `SYST:TIME 12,30`

Entering the date

The day, month and year can be entered independently of each other in the entry field:

DATE			
DATE	11	Mar	2004

To select the month, use the units key to open a list containing the month names. You can then select the month from the list.

MONTH
JAN
FEB
✓MAR
APR
MAY
JUN
JUL
AUG
SEP
OCT
NOV
DEC

IEC bus command: `SYST:DATE 2002,03,11`

2.4.3 Setting the GPIB Interface

- Press the *SETUP* key.
The *SETUP* menu will open.
- Press the *GENERAL SETUP* softkey.
The submenu with general settings will open.
- Press the *GPIB* softkey.
The submenu for setting the parameters of the remote control interface will open.

2.4.3.1 GPIB Address

- Press the *GPIB ADDRESS* softkey.
The entry field for the GPIB address will open.

The setting range is from 0 to 30. The default address is 20 if SCPI is selected as the GPIB language or 18 if an 85xx emulation is selected.

IEC bus command: `SYST:COMM:GPIB:ADDR 20`

2.4.3.2 GPIB Language

- Press the *GPIB LANGUAGE* softkey.
The list of available remote control languages will open.

The following languages are available:

- *SCPI*
- HP mode:
8560E, 8561E, 8562E, 8563E, 8564E, 8565E
8566A, 8566B, 8568A, 8568B, 71100C, 71200C, 71209A
8591E, 8594E



If entries of the HP mode are selected, the command recognition uses syntax rules which are different from syntax rules of the *SCPI* mode. Correspondingly, proper detection of *SCPI* commands is not ensured in this mode.



For 8566A/B, 8568A/B and 8594E, command sets A and B are available. Command sets A and B differ in the rules regarding the command structure.

Selecting a language different from "SCPI" will set the GPIB address to 18 if it was 20 before.

Start / stop frequency, reference level and # of sweep points will be adapted to the selected instrument model.

8568A_DC and 8568B_DC are using DC input coupling as default if it is supported by the instrument.

The HP model 8591E is compatible to HP model 8594E, the HP models 71100C, 71200C, and 71209A are compatible to HP models 8566A/B.

When the selection is changed, the following settings are changed:

SCPI:

- The instrument will perform a preset.

71100C, 71200C, 71209A, 856xA/B, 856xE, 8591E, 8594E:

- The instrument will perform a preset.
The following instrument settings will then be changed:

Model	# of Trace Points	Start Freq.	Stop Freq.	Ref Level	Input Coupling
8560E	601	0 Hz	2.9 GHz	0 dBm	AC
8561E	601	0 Hz	6.5 GHz	0 dBm	AC
8562E	601	0 Hz	13.2 GHz	0 dBm	AC

Model	# of Trace Points	Start Freq.	Stop Freq.	Ref Level	Input Coupling
8563E	601	0 Hz	26.5 GHz	0 dBm	AC
8564E	601	0 Hz	40 GHz	0 dBm	AC
8565E	601	0 Hz	50 GHz	0 dBm	AC
8566A/B	1001	2 GHz	22 GHz	0 dBm	DC (R&S FSU family) AC (R&S FSP)
8568A/B	1001	0 Hz	1.5 GHz	0 dBm	AC
8591E	401	0 Hz	3 GHz	0 dBm	AC
8594E	401	0 Hz	3 GHz	0 dBm	AC
71100C	1001	2 GHz	22 GHz	0 dBm	DC (R&S FSU family) AC (R&S FSP)
71200C	1001	2 GHz	22 GHz	0 dBm	DC (R&S FSU family) AC (R&S FSP)
71209A	1001	2 GHz	22 GHz	0 dBm	DC (R&S FSU family) AC (R&S FSP)



Note regarding the selection of 856x for the R&S FSP:

- The # of trace points is not switched over until the state changes to REMOTE. In the case of switchover to manual operation (*LOCAL* key), the number of sweep points is always changed to 501.
- If necessary, the stop frequency specified in the table is restricted to the corresponding frequency range of the R&S FSP.

```
IEC bus command: SYST:LANG "SCPI" | "8560E" |
                  "8561E" | "8562E" | "8563E" |
                  "8564E" | "8565E" | "8566A" |
                  "8566B" | "8568A" | "8568A_DC" |
                  "8568B" | "8568B_DC" | "8591E" |
                  "8594E" | "71100C" | "71200C" |
                  "71209A"
```

2.4.3.3 ID Response String

- The *ID STRING FACTORY* softkey selects the default response to the command *IDN?.

IEC bus command: --

- The *ID STRING USER* softkey opens the editor for entering a user-defined response to the command *IDN?. The max. length of the output string is 36 characters.

IEC bus command: --

2.4.4 Setting the Screen Colors

- Press the *DISP* key.
The *DISPLAY* menu will open.
- Press the *CONFIG DISPLAY* softkey.
The submenu for configuring the screen will open.
- The *DEFAULT COLORS 1 and 2* softkeys set the default setting for brightness, tint and color saturation of all screen objects. The color schemes are selected in such a manner that all screen elements will be optimally visible regardless whether viewed from above or below. In the instrument's default setting, *DEFAULT COLORS 1* is active.

IEC bus command: `DISP:CMAP:DEF1`
`DISP:CMAP:DEF2`

The procedure for setting screen colors and brightness is as follows:

- Press the *NEXT* key.
The side menu for changing the screen colors will open.

The *SELECT OBJECT* softkey activates the selection of screen elements for which the color setting needs to be changed. Once this selection is made, the *PREDEFINED COLORS*, *BRIGHTNESS*, *TINT* and *SATURATION* softkeys can be used to change the overall color or the brightness, tint and color saturation of the selected element.

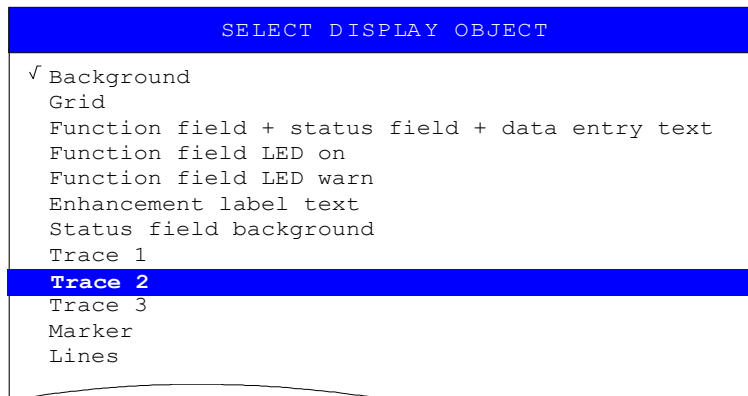

The *BRIGHTNESS* softkey activates entry of the brightness of the selected graphics element.

The entry value is between 0% and 100%.

IEC bus command: `DISP:CMAP5:HSL <hue>,<sat>,<lum>`

The *TINT* softkey activates entry of the tint for the selected graphics element. The percent value that is entered refers to a continuous color spectrum that ranges from red (0%) to blue (100%).

IEC bus command: `DISP:CMAP5:HSL <hue>,<sat>,<lum>`

The *SATURATION* softkey activates entry of the color saturation of the selected element. The entry value is between 0% and 100%.

IEC bus command: `DISP:CMAP5:HSL <hue>,<sat>,<lum>`

The *PREDEFINED COLORS* softkey opens a list for selecting predefined colors for the screen objects:



IEC bus command: `DISP:CMAP1 ... 26:PDEF <color>`

2.4.5 Automatically Switching Off the Internal Screen

The R&S FSP provides a feature for automatically switching off the screen after a user-defined period of time. The background lighting will be disabled if no entries are made from the front panel after the selected response time (key, softkey or hardkey and rotary knob).

To activate automatic switch-off:

- Press the *DISP* key.
- Press the *CONFIG DISPLAY* softkey.
- Press the *DISPLAY PWR SAVE* softkey.
The softkey will have a color background, indicating that the power save mode is active. At the same time, the input window for the response time will open.
- Enter the desired response time in minutes and confirm the entry with the *ENTER* key.
The screen will be disabled (turn dark) after the selected period of time.

To deactivate automatic switch-off:

- Press the *DISP* key.
- Press the *CONFIG DISPLAY* softkey.
- Press the *DISPLAY PWR SAVE* softkey twice.
The color background of the softkey will disappear.
The power save mode is now switched off.

2.4.6 File and Path Selection Using the Front Panel Keys

As of firmware version 4.3x the base system firmware supports new dialog boxes to select a folder and/or a file, e.g. for trace export.

The following section describes the usage of the instrument's front panel keys using TRACE EXPORT as an example.

- Press the *TRACE* key and then the *NEXT* softkey.
- Press the *ASCII FILE EXPORT* softkey to open the corresponding dialog box.

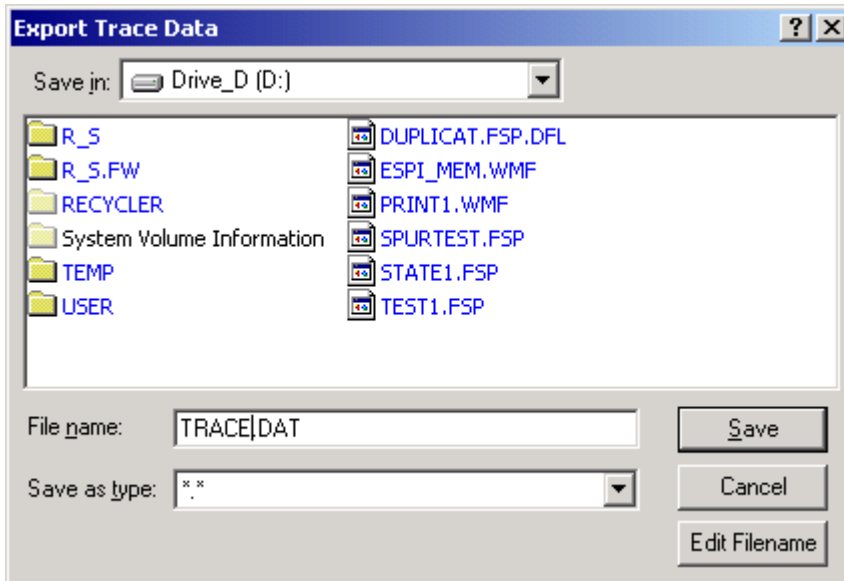

The focus is on the *File Name* field so you can directly edit the file name using the numeric keys, the cursor keys or the *BACK* key.

You can also use alphanumeric characters in the file name.

- To enter alphanumeric characters, select the *EDIT FILENAME* button. Confirm the selection with the ENTER key to open an online keyboard.

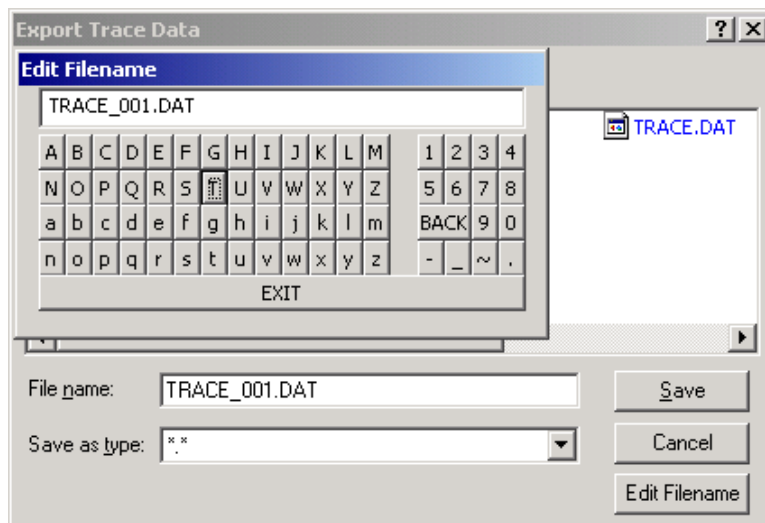

Select the characters with the rotary knob or the cursor keys and confirm with the ENTER key.

- Drive usage is checked according to the following rules:
 - first, the R&S FSP checks for a connected memory stick
 - if a memory stick is not recognized, then the R&S FSP uses the floppy drive
 - if the R&S FSP doesn't recognize a floppy drive or there is no floppy in the drive, the R&S FSP uses the internal hard disk.

Note that the path and file name are reset to their default values after an instrument *PRESET*.

- Change the drive by moving the rotary knob until the focus is on the *Save In* field.



- Press the *CURSOR RIGHT* key to open the dropdown menu and select the drive you want to save the file to with the *CURSOR UP* and *CURSOR DOWN* keys. Confirm your selection by pressing the *ENTER* key.
- Select a subfolder by moving the rotary knob until the file / subfolder list is in focus. The selected file or subfolder in focus is framed by dotted line.

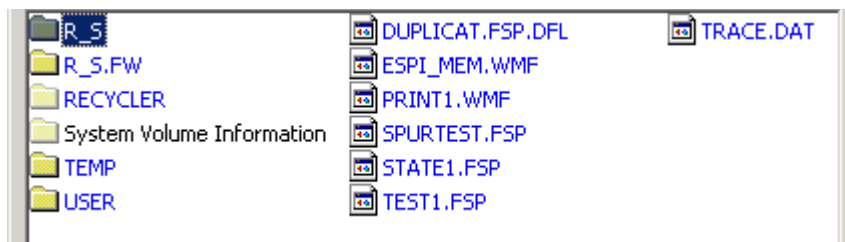

- Use the *CURSOR UP* or *CURSOR DOWN* keys to select a specific folder or file. To change the path or select a file, confirm your selection with the *ENTER* key.

Note that the R&S FSP overwrites existing files with the new data.

2.4.7 Selecting and Configuring Printers

- Press the *HCOPY* key.
The *HARDCOPY* menu will open.
- Press the *DEVICE SETUP* softkey.
The dialog box for selecting the file format and printer will open:

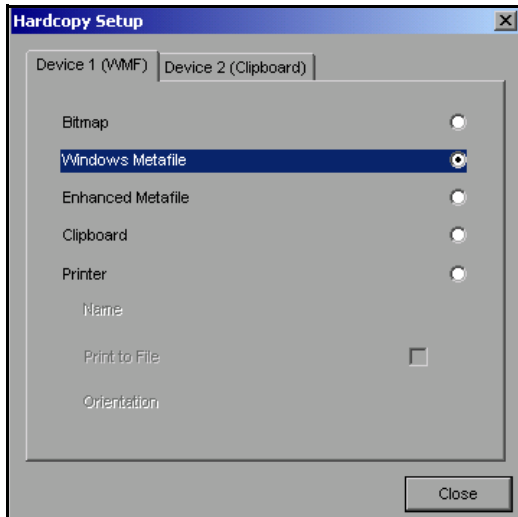

- You can select a connected printer (including a pre-configured network printer) by positioning the selection bar on the *Printer* entry by turning the rotary knob and then confirming the selection by pressing the rotary knob or the *ENTER* key.

After you confirm the selection, the entries *Name*, *Print to File* and *Orientation* will be made available and can also be accessed with the rotary knob.

- To select the printer type, open the selection list by pressing the rotary knob or the *ENTER* key after you access the *Name* field.

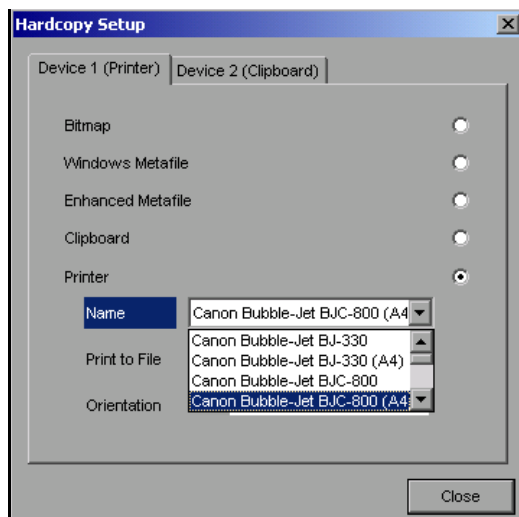

From the selection list, you can now select the printer you want (in the example, this is *Canon Bubble-Jet BJC800 (A4)*) by using the rotary knob again and then confirming your selection with *ENTER* or by pressing the rotary knob. The selection list will then disappear and the entry cursor will return to the *Name* field.

- You can also redirect the output to a file rather than to a printer. To do this, select the field *Print to File* by using the rotary knob and then mark the appropriate selection box or cancel the marking by pressing either the rotary knob or the *ENTER* key:



- You can select orientation for paper printout by using the *Orientation* field. To open the selection list, press the rotary knob or *ENTER*:

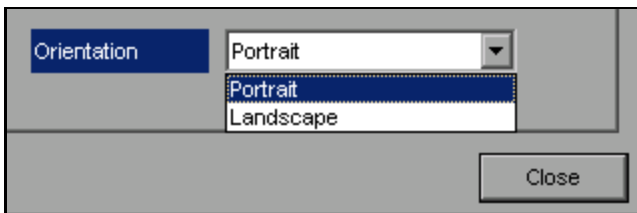

From the selection list, you can now select the orientation you want (*Portrait* in the preceding figure) by using the rotary knob again and then confirm with *ENTER* or by pressing the rotary knob. The selection list will then close and the entry cursor will return to the *Orientation* field.

You can now close the dialog box by pressing the *ESC* key or by selecting and confirming the *Close* button.

2.4.7.1 Selecting Alternative Printer Configurations

The R&S FSP can support two independent hardcopy settings. This allows you to quickly switch between output to a file and a printer.

- To make a selection, use the *DEVICE 1 / 2* softkey, which simultaneously shows the associated setting when the *Hardcopy Setup* dialog box is open.

IEC bus command: -

2.4.7.2 Selecting Printer Colors

- The *COLORS* softkey opens the submenu for selecting the colors for the printout. To make it easier for you to select colors, the selected hardcopy color combination is displayed on screen when you access the menu. When you exit the menu, the system switches back to the previous color combination.
- The *COLOR ON OFF* softkey switches from color output to black-and-white printout. In this case, all background colors will be printed out in white and all color lines in black. This allows you to improve contrast on the printout. The basic setting is *COLOR ON*.

IEC bus command: `HCOP:DEV:COL ON`

- The *SCREEN COLORS* softkey selects the current screen colors for the printout.



The background will always be printed out in white and the grid in black.

IEC bus command: `HCOP:CMAP:DEF1`

- The *OPTIMIZED COLORS* softkey selects an optimized color setting for the printout in order to improve color clarity on the printout.

With this selection, trace 1 will be printed out in blue, trace 2 in black, trace 3 in green and the markers in turquoise.

The other colors correspond to the screen colors of the *DISP – CONFIG DISPLAY - DEFAULT COLORS 1* softkey.



The background will always be printed out in white and the grid in black.

IEC bus command: `HCOP:CMAP:DEF2`

- The *USER DEFINED* softkey opens a submenu for user-defined color selection (see the *USER DEFINED COLORS* submenu).

The procedure for making the settings is similar to that for setting the screen colors.

IEC bus command: `HCOP:CMAP:DEF3`

2.4.8 Installing Plug&Play Printers

Plug&play printers can be easily installed under Windows XP:

After you connect and switch on a printer, Windows XP automatically detects the printer and installs the associated driver, provided that the driver is contained in the Windows XP installation.

If Windows XP does not find the printer driver, it will prompt you to enter a path for the associated installation files. In addition to the pre-installed drivers, a number of additional printer drivers are found in the D:\I386 directory.

You can find a detailed step-by-step procedure in Appendix A, section “[Installing Non-Plug&Play Printers](#)” on page A.6.



When you install printer drivers that are not pre-installed on the instrument, the installation process will prompt you to specify the path containing the new driver. This can be a disk in drive A. Alternatively, the driver can also be loaded from a memory stick or USB CD-ROM drive (see the section “[Connecting USB Devices \(e.g. a Power Meter\)](#)” on page 2.13).

Configuring the LAN Interface (Option R&S FSP-B16 only)

2.4.9 Installing Non-Plug&Play Printers

The procedure for installing non-plug&play printers is described in appendix A, section “Installing Non-Plug&Play Printers” on page A.6.

2.5 Configuring the LAN Interface (Option R&S FSP-B16 only)

The instrument can be connected to an Ethernet LAN (local area network) using the LAN interface connector on the rear panel. This makes it possible to transfer data over the network and to use network printers. In addition, the instrument can be remote-controlled via the network. The network card can be operated with a 10 MHz Ethernet IEEE 802.3 or a 100 MHz Ethernet IEEE 802.3u interface.

2.5.1 Connecting the Instrument to the Network

NOTICE

Before connecting the instrument to the network, consult your network administrator, particularly in the case of large LAN installations. Connection errors may affect the entire network.

Connect a conventional RJ-45 cable (not supplied) to the rear panel of the instrument and a network hub of the required LAN segment. Since the RJ-45 involves star configuration rather than bus cabling, no special measures need to be taken.



Setting up the connection does not cause any problems on the network. Likewise, disconnecting the instrument from the network does not cause any problems as long as no data traffic to and from the instrument is in progress.

2.5.2 Configuring the Network Card

2.5.2.1 Driver Installation

Under Windows XP, network card drivers do not need to be installed separately if the option R&S FSP-B16 has been factory-installed.

All you need to do is connect the network cable to the LAN-Interface connector on the instrument rear panel. Windows XP automatically detects the network connection and activates the required drivers.

Configuring the LAN Interface (Option R&S FSP-B16 only)

2.5.2.2 Configuring the Interface

To configure the interface, do the following:

- Press the SETUP key.
The SETUP menu will open.
- Press the GENERAL SETUP softkey.
The submenu with all general settings will open.
- Press the *CONFIGURE NETWORK* softkey.
The dialog box with the network settings will open.

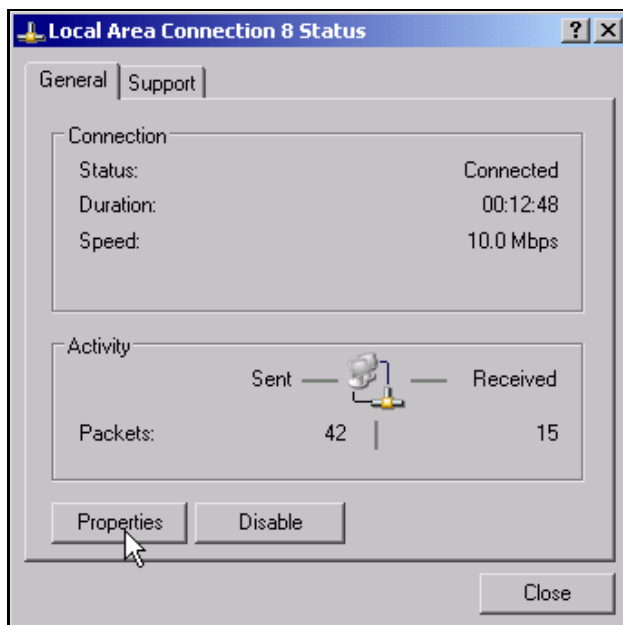

This softkey allows you to change the existing network configuration depending on the selection of the affected registration cards (see section “[Configuring Existing Network Protocols \(TCP/IP Protocol\)](#)” on page 2.31).

IEC bus command: -



Before you can configure network support, a PC keyboard with a trackball (or an additional mouse rather than a trackball) must be connected.

2.5.2.3 Configuring Existing Network Protocols (TCP/IP Protocol)

Before starting, check whether your network a DHCP server. If necessary, ask your network administrator.

- If your network has a DHCP server, the IP address is to be requested from a DHCP server automatically. This is the default setting and no change of configuration is necessary.
- If your network has no DHCP server, change the settings according to the following step-by-step instructions. Use IP addresses and subnet masks suitable for your network. If necessary, contact your network administrator.

Configuring the LAN Interface (Option R&S FSP-B16 only)

- Open the Windows XP Start menu by pressing the Windows key or *CTRL+ESC*.
- Click *Settings - Network Connections - Local Area Connection*.

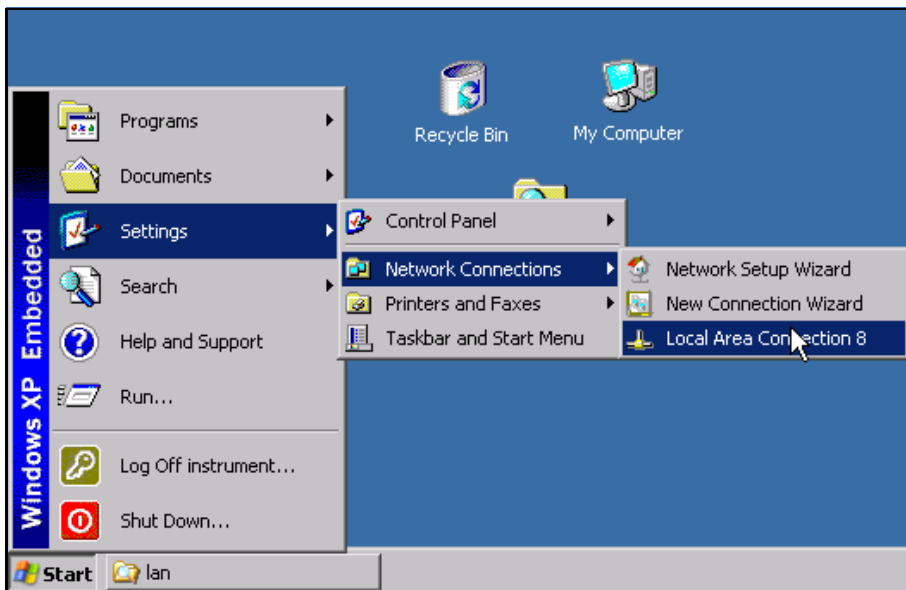

The *Local Area Connection Status* dialog box will open.

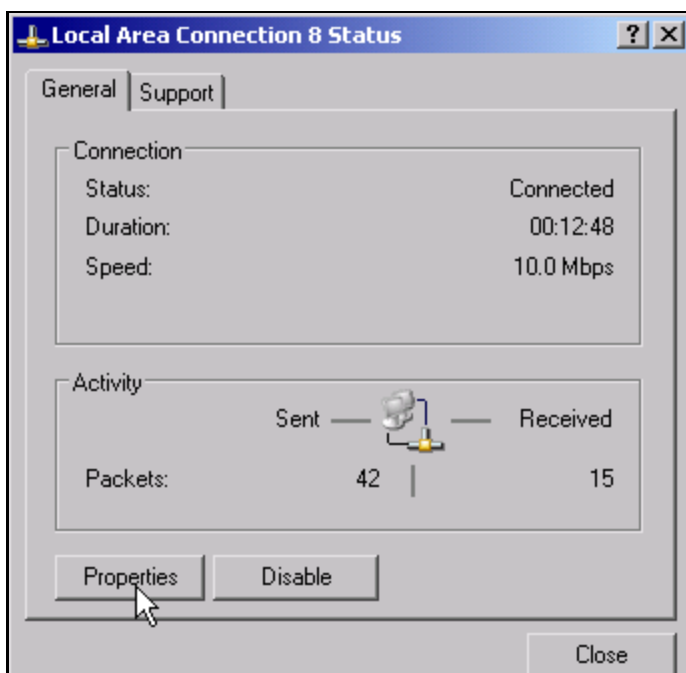

Windows XP automatically appends numbers to the name Local Area Connection Status (e.g. Local Area Connection Status 8) if the configuration is set up using the New Connection wizard. These numbers are not important in the following configuration steps and are therefore omitted.

Configuring the LAN Interface (Option R&S FSP-B16 only)

- Click the *Properties* button.
The window with the available network protocols opens.

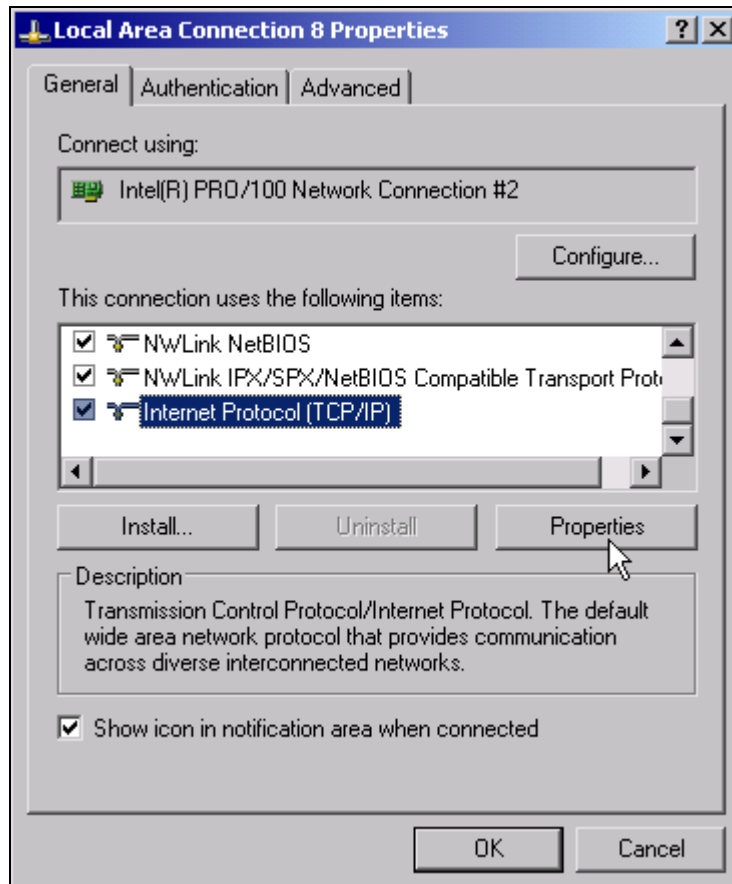

- Click the network protocol you want (TCP/IP in the example).
- Click the *Properties* button.
The dialog box with the settings for the selected network protocol will open. By default, *Obtain an IP address automatically* is selected.

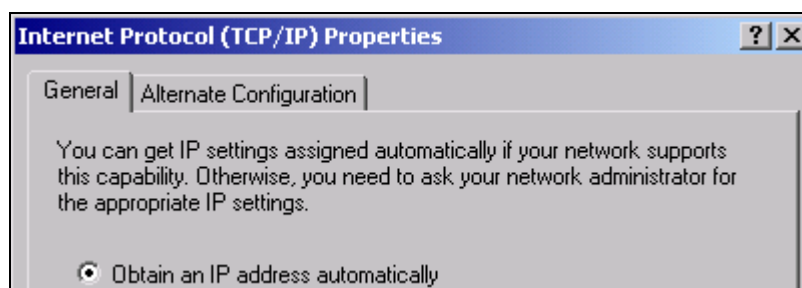

- Select *Use the following IP address* to enter a predefined IP address.

Configuring the LAN Interface (Option R&S FSP-B16 only)

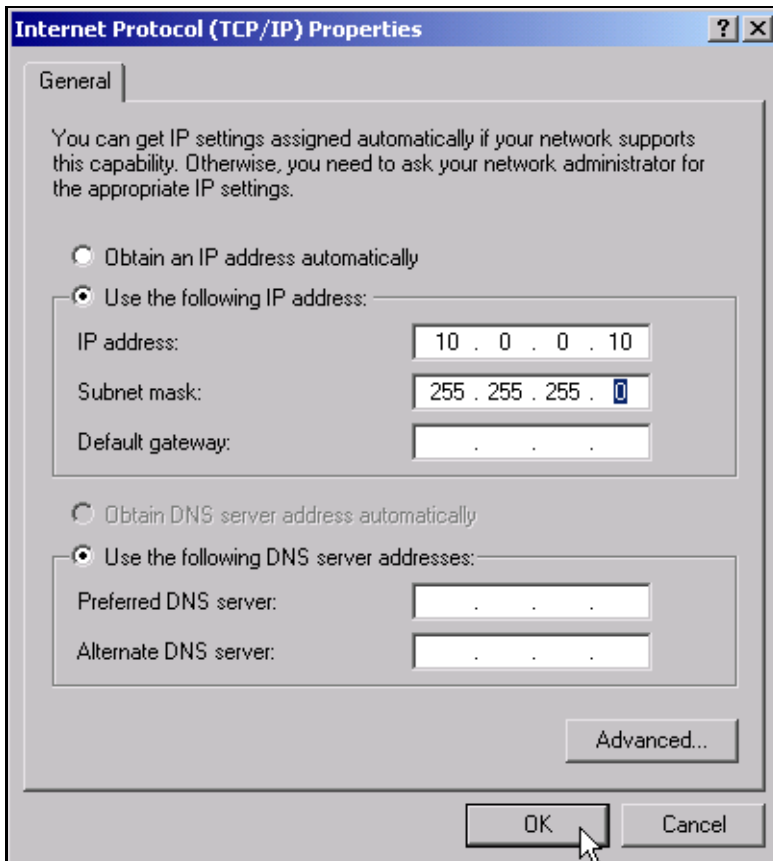

- Select *IP address* and enter the IP address.
- Select *Subnet mask* and enter the required mask.
- Click *OK*.

Windows XP will check the entered settings for correctness and then store the configuration.

If you have entered an invalid IP address or subnet mask, an error message will appear that also asks you whether you want to enter a different address or mask:

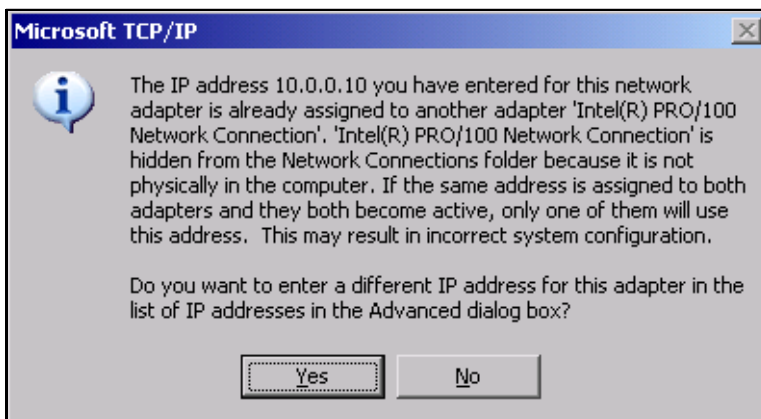

- Click *Yes*.
- The dialog box for entering the TCP/IP parameters will open again.

If all settings are correct, you will be prompted to restart the instrument if required by the changes.

Configuring the LAN Interface (Option R&S FSP-B16 only)

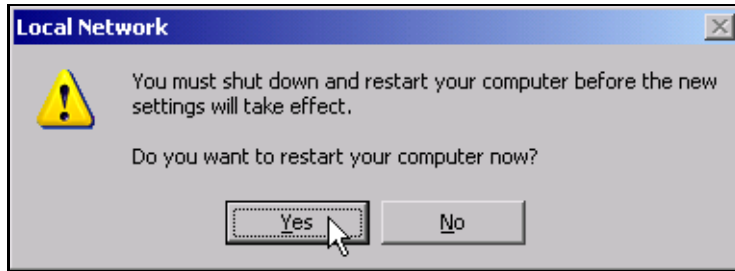

- Click Yes.
Windows XP will restart the system.

2.5.2.4 Installing Additional Network Protocols and Services

The procedure for installing additional network protocols and services is provided in the chapter “[Installing Additional Network Protocols & Services](#)” on page 6.3.

2.5.3 Login

Windows XP requires that users identify themselves by entering a user name and password in a login window. The instrument provides a factory-installed auto login function, i.e. login is carried out automatically in the background. The ID used for auto login has administrator rights. As user name and password *instrument* (lowercase) are set.

For information on how to deactivate the automatic login, refer to chapter “[LAN Interface](#)”, section “[Deactivating the Automatic Login Mechanism](#)” on page 6.14.

2.6 LXI Configuration

LAN eXtensions for Instrumentation (LXI) is an instrumentation platform for measuring instruments and test systems that is based on standard Ethernet technology. LXI is intended to be the LAN-based successor to GPIB, combining the advantages of Ethernet with the simplicity and familiarity of GPIB.

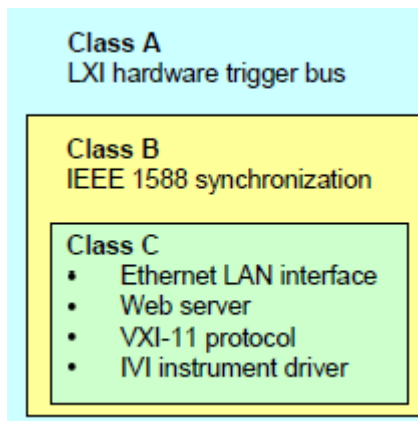

- Class C instruments are characterized by a common LAN implementation, including an ICMP ping responder for diagnostics. The instruments can be configured via a web browser; a LAN Configuration Initialize (LCI) mechanism resets the LAN configuration.
The LXI class C instruments shall also support automatic detection in a LAN via the VXI-11 discovery protocol and programming by means of IVI drivers.
- Class B adds IEEE 1588 Precision Time Protocol (PTP) and peer-to-peer communication to the base class. IEEE 1588 allows all instruments on the same network to automatically synchronize to the most accurate clock available and then provide time stamps or time-based synchronization signals to all instruments with exceptional accuracy.
- Class A instruments are additionally equipped with the eight-channel hardware trigger bus (LVDS interface) defined in the LXI standard.

Instruments of classes A and B can generate and receive software triggers via LAN messages and communicate with each other without involving the controller.

The R&S FSP complies with LXI class C. In addition to the general class C features described above, it provides the following LXI-related functionality:

- Integrated LXI Configuration dialog for LXI activation and reset of the LAN configuration (LAN Configuration Initialize, LCI).



The LXI functionality requires a Windows XP operating system that has been upgraded to service pack 2. Please contact your Rohde & Schwarz service representative if your R&S FSP's operating system needs an upgrade. To check the version of your operating system, open the Versions+Options dialog box in the General Setup submenu.

After a firmware update, use the standby key to shut-down and re-start the instrument in order to enable the full LXI functionality.

For information about the LXI standard refer to the LXI website at <http://www.lxistandard.org>. See also "News from Rohde & Schwarz, article 2006/II - 190".

2.6.1 LXI Configuration Dialog

This dialog provides basic LXI information for the R&S FSP. Press the *INFO* softkey in the General Setup menu to open the LXI Configuration dialog box.

Default State of the Network Settings

According to the LXI standard, LAN reset must place the following parameters to a default state. For details on resetting the R&S FSP refer to the Operating Manual, chapter 4.

Parameter	Value
TCP/IP Mode	DHCP + Auto IP Address
Dynamic DNS	Enabled
ICMP Ping	Enabled
Password for LAN configuration	LxiWebIfc

The LAN Reset for the R&S FSP also resets the following parameters:

Parameter	Value
Description	R&S Spectrum Analyzer/FSP/<serial number>
Negotiation	Enabled
VXI-11 Discovery	Enabled

The LAN settings are configured using the instrument's LXI Browser Interface.

2.6.2 LXI Browser Interface

The instrument's LXI browser interface works correctly with all W3C compliant browsers. Typing the instrument's host name or IP address in the address field of the browser on your PC, e.g. <http://10.113.10.203> , opens the Instrument Home Page (welcome page).

The instrument home page displays the device information required by the LXI standard including the VISA resource string in read-only format.

The LAN Status toggle button causes the LXI logo in the status bar of the R&S FSP to blink (if active). A green LXI status symbol indicates that a LAN connection has been established; a red symbol indicates that no LAN cable is connected. The LAN Status setting is not password-protected.

The navigation pane of the browser interface contains the following control elements:

- LAN Configuration opens the LAN Configuration page.
- LXI Glossary opens a document with a glossary of terms related to the LXI standard.
- Status displays information about the LXI status of the instrument.

2.6.3 LAN Configuration website

The LAN Configuration web page displays all mandatory LAN parameters and allows their modification.

The TCP/IP Mode configuration field controls how the IP address for the instrument gets assigned (see also <Link to IP Address Settings>). For the manual configuration mode, the static IP address, subnet mask, and default gateway are used to configure the LAN. The automatic configuration mode uses DHCP server or Dynamic Link Local Addressing (Automatic IP) to obtain the instrument IP address.



Changing the LAN configuration is password-protected. The password reads LxiWebIfc (notice upper and lower case characters).

The links across the bottom of the LAN Configuration page open other pages:

Ping Client provides the ping utility to verify the connection between the instrument and other devices.

Advanced LAN Configuration provides LAN settings that are not declared mandatory by the LXI standard.

The Advanced LAN Configuration parameters are used as follows:

- The Negotiation configuration field provides different Ethernet speed and duplex mode settings. In general, the Auto Detect mode is sufficient.
- ICMP Ping must be enabled to use the ping utility.
- VXI-11 is the protocol that is used for discovery of the instrument in the LAN. According to the standard, LXI devices must use VXI-11 to provide a discovery mechanism; other additional discovery mechanisms are permitted.

2.6.4 Ping

Ping is a utility that verifies the connection between the LXI-compliant instrument and another device. The ping command uses the ICMP echo request and echo reply packets to determine whether the LAN connection is functional. Ping is useful for diagnosing IP network or router failures.

The ping utility is not password-protected. To initiate a ping between the LXI-compliant instrument and a second connected device,

1. Enable ICMP Ping on the Advanced LAN Configuration page (enabled after an LCI).
2. Enter the IP address of the second device without the ping command and without any further parameters into the Destination Address field (e.g. 10.113.10.203).
3. Click Submit.

2.7 Operating System Properties

2.7.1 Properties Specific to Windows XP

The instrument contains the Windows XP operating system. To ensure that the instrument software functions properly, certain rules must be adhered to when using the operating system.

NOTICE

The drivers and programs used under Windows XP have been adapted to the instrument. To avoid impairments to instrument function, use only the settings described in the Operating Manual and this manual.

Only update software approved by Rohde & Schwarz may be used to modify existing instrument software. Likewise, only programs approved by Rohde & Schwarz for use on the instrument may be run on the instrument.

Login

For details refer to section “[Login](#)” on page 2.35.

Administrator ID

The ID used by the instrument to perform auto login has administrator rights.

2.7.1.1 Windows XP Service Packs

The Windows XP operating system on the instrument is supplied with pre-installed XP service packs (SP2 and additional updates/fixes) that are necessary and suitable for operating the instrument.

NOTICE

Possible impairment of the instrument functioning

The instrument is equipped with the Windows XP operating system. It is thus possible to install commercial off-the-shelf software on the instrument. The use and installation of commercial software may impair the instrument functions. We recommend that you only execute programs tested by Rohde & Schwarz with regard to their compatibility to the instrument software. The program packages that have been tested are listed in section “[Windows XP Software Approved for the Instrument](#)”.

Install only service packs approved by Rohde & Schwarz to avoid impairment of instrument functions that could lead to the necessity to repair the instrument.

The drivers and programs used on the instrument under Windows XP have been adapted to the instrument. Existing instrument software must only be modified with update software released by Rohde & Schwarz.

2.7.1.2 Opening the Windows XP Start Menu

You can open the Windows XP Start menu by pressing the Windows key () or the key combination *CTRL+ESC*. From the start menu, you can navigate to the submenus by using the mouse or the arrow keys. To return to the measurement screen, activate the *R&S Analyzer Interface* button in the task bar.

You can also open the Windows Start menu with the *OPEN START MENU* softkey in the *SETUP* menu.

2.7.1.3 Windows XP Software Approved for the Instrument

The driver software that is used and the system settings of Windows XP have been fine-tuned to support the measurement functions of the R&S FSP. Thus, flawless instrument function is ensured only if software and hardware approved or offered by Rohde & Schwarz are used.

Using other software or hardware may cause the functions of the R&S FSP to perform improperly or fail.

The following program packages have been successfully tested for compatibility with the measurement instrument software:

- R&S FS-K3 – Software for measuring noise factor and gain
- R&S FS-K4 – Software for measuring phase noise
- R&S Power Viewer (virtual power meter for displaying results of the power sensors of the R&S NRP-Zxx series)
- Windows XP Remote Desktop
- FileShredder – For reliable deletion of files on the hard disk
- Symantec Norton AntiVirus – Virus-protection software
- McAfee Virusscan

3 Firmware Update and Installation of Firmware Options

3.1 Firmware Update	3.2
3.2 Activating Firmware Options	3.3

3.1 Firmware Update

For the latest firmware version refer to the Rohde & Schwarz internet site and download the most up-to-date firmware.

A detailed description about performing the firmware update in the instrument is given in the release note, provided on this CD. The release note is also downloadable from the Rohde & Schwarz internet site.

You can install a new firmware version by using the built-in disk drive, a memory stick, a USB CD-ROM, or LAN. The firmware update kit contains several disks whose contents must be stored in separate directories (Disk1 to Disk<n>) when a memory stick or LAN is used. Start the installation program from the *SETUP* menu.

- Press the *SETUP* key.
The *SETUP* menu will open.
- Press the *NEXT* key.
The side menu will open.
- Press the *FIRMWARE UPDATE* softkey.
The subdirectory for installing or uninstalling new firmware versions will open.
- Press the *UPDATE PATH* softkey (only in the case of firmware updates via a memory stick, CD-ROM or LAN). The entry field for the path with the set of update disks will open.
- Enter the drive name and directory and confirm with *ENTER*.

Example:

The firmware update files are stored on a memory stick in the *Update* directory. They are allocated in the *Disk1* to *Disk<n>* subdirectories. After you insert the memory stick, it will be detected as drive *E:*.

In this case, the required path specification is *E:\UPDATE*.

- To start the installation program, press the *FIRMWARE UPDATE* softkey in the submenu.
- Confirm the query *DO YOU REALLY WANT TO UPDATE THE FIRMWARE?* with *OK*.
The installation program will then guide you through the remainder of the update procedure. The instrument will perform several automatic shutdowns, until the new base system firmware is installed properly.

NOTICE

Do not switch the instrument off until the update process has been finished completely.

IEC bus command: "SYST:FIRM:UPD 'E:\UPDATE' "

- To restore the previous firmware version, press the *RESTORE FIRMWARE* softkey.

IEC bus command: --

3.2 Activating Firmware Options

Firmware options are enabled by entering license keys via the following operating sequence:

- Press the *SETUP* key.
The *SETUP* menu will open.
- Press the *GENERAL SETUP* softkey.
- Press the *OPTIONS* softkey.
The *OPTIONS* menu will open. Options already available are listed in a table that is displayed when the submenu is opened.

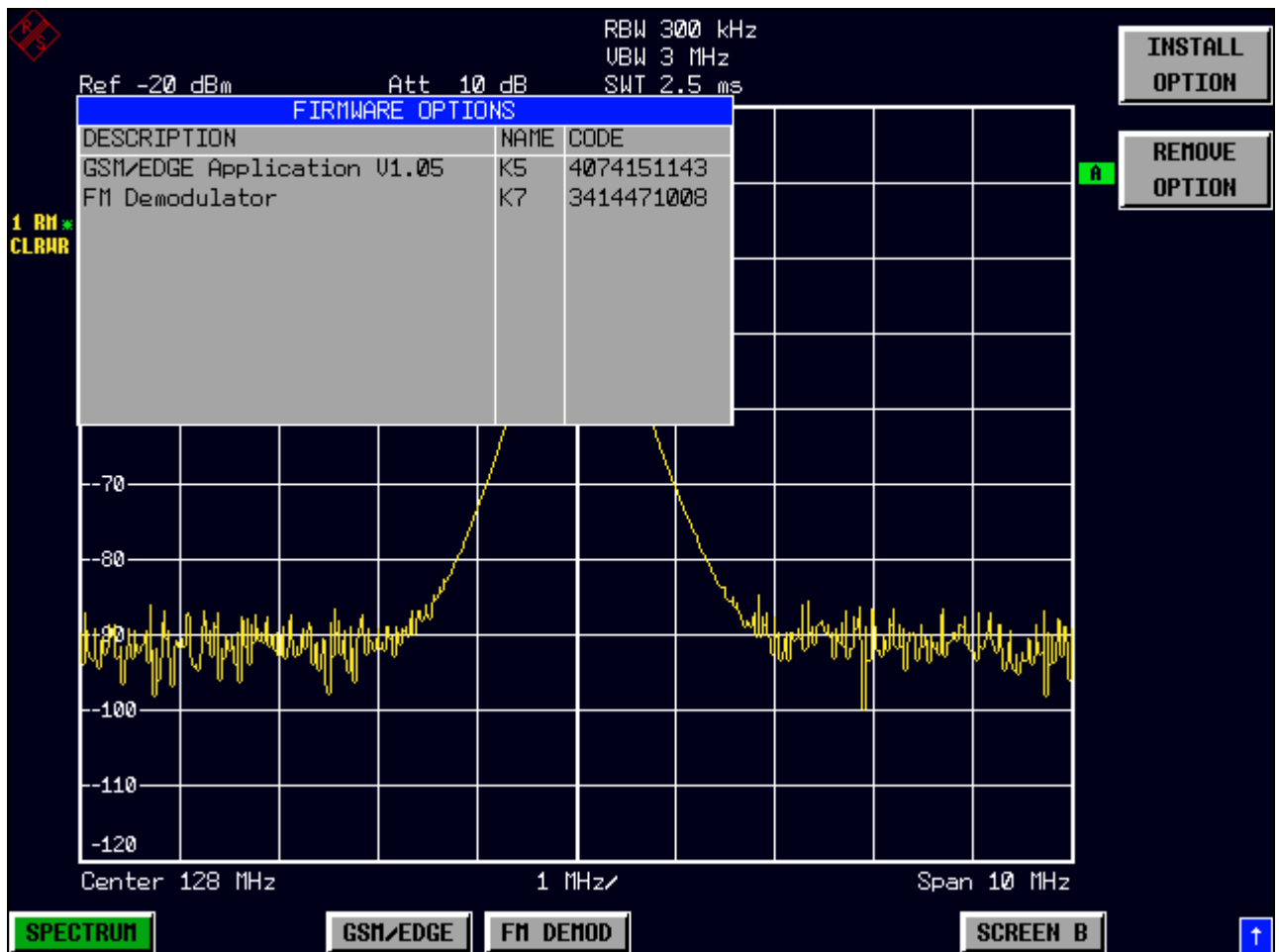

- Press the *INSTALL OPTION* softkey.
The field for entering the license key for the firmware option now appears.
After you enter a valid license key, *OPTION KEY OK* will appear in the message line and the option will be entered in the *FIRMWARE OPTIONS* table.
If you enter an invalid license key, the message *OPTION KEY INVALID* will appear in the message line.
- The *REMOVE OPTION* softkey deletes all existing firmware options. To prevent unintentional deletion, the system asks you to confirm that you really want to perform this operation.

4 Basic Operation

4.1 Diagram Layout	4.2
4.1.1 Displays in the Diagram Area	4.3
4.2 Setting Parameters	4.7
4.2.1 The Keypad	4.7
4.2.2 The Rotary Knob and Arrow Keys	4.8
4.2.3 Editing Numeric Parameters	4.8
4.2.4 Editing Alphanumeric Parameters	4.9
4.2.4.1 Alphanumeric Editor Type 1:	4.9
4.2.4.2 Alphanumeric Editor Type 2:	4.10

4.1 Diagram Layout

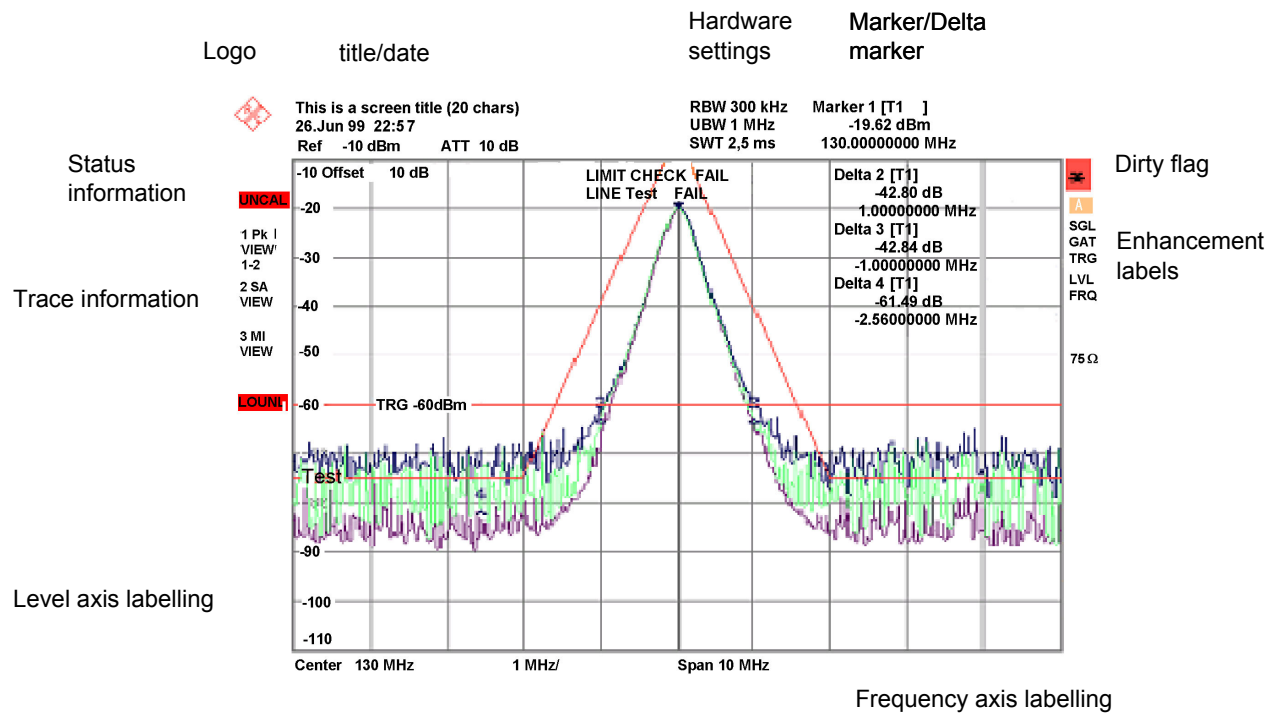

Fig. 4-1 Screen layout of the R&S FSP during analyzer operation

4.1.1 Displays in the Diagram Area

Hardware settings

Ref	Display of the reference level.
Offset	Display of the reference level offset.
Att	Display of the RF attenuation that has been set.
EATT	Display of the set RF attenuation when an electronic attenuator is used (only with option Electronic Attenuator, R&S FSP-B25).
RBW	Display of the resolution bandwidth that has been set. If the bandwidth does not correspond to the value for automatic coupling, a green asterisk "*" will appear in front of the field.
VBW	Display of the video bandwidth that has been set. If the bandwidth does not correspond to the value for automatic coupling, a green asterisk "*" will appear in front of the field.
SWT	Display of the sweep time that has been set (<i>SWEEP TIME</i>). If the sweep time does not correspond to the value for automatic coupling, an asterisk "*" will appear in front of the field. The color of the asterisk will turn to red if the sweep time is set below the value for automatic coupling. In this case, the sweep time must be increased.
Marker / Delta	Contains the x and y axis positions of the last marker or delta marker that was set as well as its index. The value in the square brackets after the index indicates the trace to which the marker is assigned as well as the active measurement function. The measurement functions of the markers are indicated with the following abbreviations: <ul style="list-style-type: none"> • FXD Reference fixed marker active • PHN Phase noise measurement active • CNT Frequency counter active • TRK Signal track active • NOI Noise measurement active • MOD Measurement of the AM modulation depth active • TOI measurement active
LIMIT CHECK	Display of the results of the limit check.

Status displays

The status displays on the left side of the diagram indicate any irregularities (e.g. UNCAL).

UNCAL Indicates that one of the following conditions is present:

- Correction data has been switched off (*CAL* menu, *CAL CORR OFF*).
 - Switch on the correction *CAL CORR ON* or *PRESET*.
- No valid correction values are available. This occurs, for example, if a firmware update is performed followed by a cold start of the instrument.
 - Record the correction data (*CAL* menu, *CAL TOTAL*).

OVLD Indicates an overload of the input mixer.

- Increase the RF attenuation.

IFOVL Indicates an overload of the IF signal path after the input mixer.

- Increase the reference level.

LOUNL Indicates that an error was detected in the instrument's frequency processing hardware.

EXREF Is displayed if the instrument was set to an external reference but no signal was detected on the reference input.

OVEN Indicates that the OCXO reference frequency (option R&S FSP-B4) has not yet reached its operating temperature. The message usually disappears a few minutes after power-on.

OVTRC Indicates a temporary overload condition of the input mixer or IF signal path while the trace is measured with Max Hold, Min Hold or Average (Overload Trace). OVLD and IFOVL override this indication.

Trace information

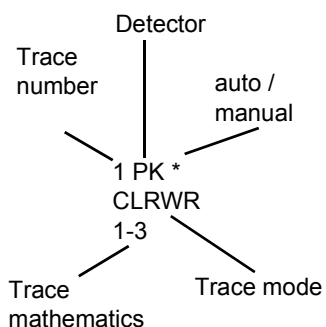

Trace

Trace number

Detector

Selected detector:

- AP: AUTOPEAK detector
- PK: MAX PEAK detector
- MI: MIN PEAK detector
- SA: SAMPLE detector
- AV: AVERAGE detector
- RM: RMS detector
- QP: QUASIPeAK detector

auto / manual

The selected detector does not match the one for automatic coupling.

Trace Mode

Display of the sweep mode:

- CLRWR: CLEAR/WRITE
- MAXH: MAX HOLD
- MINH: MIN HOLD
- AVG: AVERAGE
- VIEW: VIEW

Trace Mathematics

Indicates that the trace difference function is activated, e.g. 1-3 in the example means that trace 3 is subtracted from trace 1.

Enhancement labels:

The enhancement labels on the right-hand side of the measurement diagram indicate that the user chose instrument settings that affect the measurement results even though this is not immediately apparent from the display of the measured values.

* (star) The current instrument setting does not match the one during which the displayed traces were recorded. This occurs in the following cases:

- The instrument setting is changed while a measurement is in progress.
- The instrument setting is changed in the SINGLE SWEEP mode after the end of the sweep, and a new sweep is not started.
- The instrument setting is changed after a trace has been set to VIEW.

The display remains on screen until the user eliminates the cause. In some cases, this involves starting a new sweep (SINGLE SWEEP mode) or switching the affected trace to BLANK.

A/B Designation for screen A/B. If screen A/B is activated for entering measurement parameters, the label background will be in color.

SGL The sweep is set to SINGLE SWEEP.

GAT The frequency sweep is controlled via the EXT TRIG/GATE connector.

TRG Instrument triggering is not free running (\neq FREE RUN).

LVL A level offset \neq 0 dB is set.

FRQ A frequency offset \neq 0 Hz is set.

TDF A TRANSDUCER FACTOR is activated.

PRN Printer output is active.

75 Ω The input impedance of the instrument is set to 75 Ω .

EXT The instrument is configured for operation with an external reference.

PA The RF PREAMPLIFIER is switched on (option R&S FSP-B25).

PS The PRESELECTOR is switched on.

3DB Gauss Filter (3 dB)

6DB EMI Filter (6 dB)

FFT FFT Filter

CHN Channel Filter

RRC RRC Filter

4.2 Setting Parameters

4.2.1 The Keypad



The keypad is used to enter numeric parameters. It contains the following keys:

- Numeric keys 0...9
- Decimal point
Inserts a decimal point "." at the cursor position.
- Sign key
Changes the sign of a numeric parameter.
In the case of an alphanumeric parameter, inserts a "-" at the cursor position.
- Unit keys (*GHz/-dBm MHz/dBm, kHz/dB and Hz/dB*)
These keys add the selected unit to the entered numeric value and complete the entry.
In the case of level entries (e.g. in dB) or dimensionless values, all units have the value "1" as multiplying factor. Thus, they have the same function as an *ENTER* key. The same is true for an alphanumeric entry.
In addition, the unit keys open and close selection fields in tables (subtables).
- *BACK* key
 - If a numeric entry has already been started, this key deletes the character to the left of the cursor.
 - If an entry has been completed or not yet started, this key toggles between the currently and previously valid value (UNDO function).
- *ESC/CANCEL* key
 - Closes the entry field if an entry has been started or has not yet been made. The original value is retained.
 - Closes the entry field if an entry has been completed.
 - Closes the *System Messages* dialog box.
- *ENTER* key
 - Concludes dimensionless entries. The new value is accepted.



With frequency entries, the *ENTER* key corresponds to the *Hz* key. With time data, it corresponds to the μ s (kHz) key.

4.2.2 The Rotary Knob and Arrow Keys

The rotary knob and arrow keys are located next to the keypad.

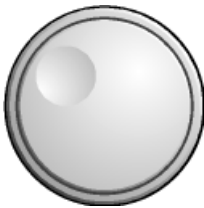

The rotary knob has several functions:

- Increments (clockwise direction) or decrements (counterclockwise direction) the instrument parameter at a defined step width in the case of a numeric entry.
- Shifts the selection bar horizontally or vertically within tables as long as an entry field is not open. The arrow keys are used to change the direction of motion (horizontal/vertical).
- Selects the individual letters when the alphanumeric editor is used.
- Shifts markers, limit lines, etc. on the screen.
- When it is pressed, it concludes an entry.

Within a table, the arrow keys move the selection bar to the desired position.



Within the alphanumeric editor, the  or  arrow keys move the cursor to the desired position.

The  or  arrow keys do the following:

- Increase or decrease the instrument parameter in the case of numeric entries.
- Switch between the editing line and the character selection in the case of alphanumeric entries.

4.2.3 Editing Numeric Parameters

Numeric values are always entered in a data entry field that automatically appears after the parameter is selected.

START FREQUENCY	_____	Title line with parameter designation
10.2457535 GHz	_____	Editing line with parameter value and unit
START FREQUENCY OUT OF RANGE	_____	Status and error messages



The title line shows the name of the instrument parameter that was selected. The entry is performed in the editing line. After the entry field is opened, it will contain the currently valid parameter value and its unit. The optional third and fourth lines show status and error messages which always refer to the current entry.

4.2.4 Editing Alphanumeric Parameters

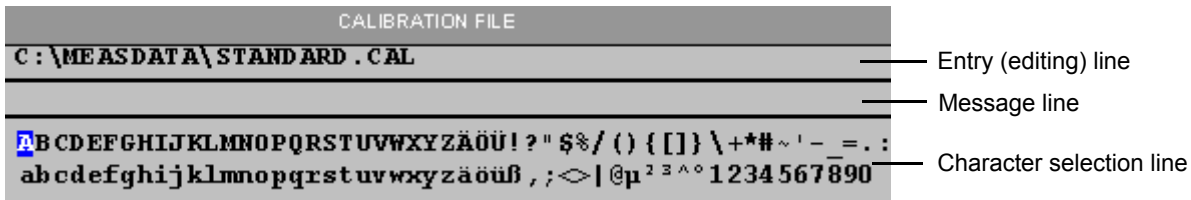

If an external keyboard is not available, the character selection field is automatically opened for entering alphanumeric parameters. Two models of the alphanumeric editor are available.

4.2.4.1 Alphanumeric Editor Type 1:





The  or  arrow keys switch between the editing line and the character selection field.

Entering the text

- Select the parameter.
Data entry is automatically activated after the data entry field is opened. The cursor is now located at the start of the previous entry in the editing line.
- Using the  arrow key, place the cursor in the character selection field.
The cursor now marks the first letter of the editor.
- Using the  and  arrow keys or the rotary knob, place the cursor on the character that you want to enter in the editing line.
- Press either the *ENTER* key or the rotary knob.
The character will be added to the editing line.

Correcting the entry

- Using the  arrow key, place the cursor in the editing line.
- Using the  and  arrow keys or the rotary knob, place the cursor after the character you want to delete.
- Press the *BACK* key.
The entry to the left of the cursor will be deleted.

Correcting the entry

- Using the  key, place the cursor in the editing line.
- Press one of the unit keys or the rotary knob.
The data entry field will close, and the new entry will be accepted by the instrument.

Cancelling the entry

- Press the *ESC* key.
The data entry field will close, and the previous entry will be retained.

4.2.4.2 Alphanumeric Editor Type 2:





													1	2	3	4	5	6	7	8	9	0
A	B	C	D	E	F	G	H	I	J	K	L	M	:	\	.	/	^	+	-	=	,	
N	O	P	Q	R	S	T	U	V	W	X	Y	Z	<	>	()	{	}	[]	#	~
a	b	c	d	e	f	g	h	i	j	k	l	m	'	@	;		?	!	"	€	\$	%
n	o	p	q	r	s	t	u	v	w	x	y	z	«	»	BACK		EXIT					
SPACE																						

The entry area consists of two parts:

- The editing line
- The character selection field

The  or arrow keys switch between the editing line and the character selection field.



Entering the text

- Select a parameter.
Data entry is automatically activated after the data entry field is opened. In tables, the character selection field is accessed by using the  arrow key.
The cursor is now located at the start of the existing entry in the editing line.
- Using the  arrow key, place the cursor in the character selection field.
The cursor now marks the first character of the editor.
- Using the  and  arrow keys or the rotary knob, place the cursor on the character that you want to enter in the editing line.
- Press the *ENTER* key or the rotary knob.
The character will be added to the editing line.

Correcting the entry (alternative 1)

- Using the rotary knob, go to the << character in the character selection field.
- By pressing the rotary knob on << and >>, place the cursor after the character you want to delete.
- Using the rotary knob, select the BACK field and press the rotary knob.
The entry to the left of the cursor in the editing line will be deleted.

Correcting the entry (alternative 2)

- Using the  arrow key, place the cursor in the editing line.
- Using the  and  arrow keys or the rotary knob, place the cursor after the character you want to delete.
- Press the *BACK* key.
The entry to the left of the cursor will be deleted.

Completing the entry (alternative 1)

- Using the rotary knob, select the EXIT field and then press the rotary knob.
The data entry field will close, and the new entry will be accepted by the instrument.

Completing the entry (alternative 2)

- Using the  arrow key, place the cursor by the editing line.
- Press one of the unit keys or the rotary knob.
The data entry field will close, and the new entry will be accepted by the instrument.

Cancelling the entry

- Press the *ESC* key.
The data entry field will close, and the previous entry will be retained.

5 Basic Measurement Examples

5.1 Measuring a Sinusoidal Signal	5.3
5.1.1 Measuring the Level and Frequency with Markers	5.3
5.1.1.1 Procedure	5.3
5.1.1.2 Increasing the Frequency Resolution	5.4
5.1.1.3 Setting the Reference Level	5.5
5.1.2 Measuring the Signal Frequency using the Frequency Counter	5.6
5.2 Measuring Harmonics of Sinusoidal Signals	5.8
5.2.1 Measuring the Suppression of the First and Second Harmonic of an Input Signal	5.8
5.2.2 Reducing Noise	5.9
5.3 Measuring Signal Spectra with Multiple Signals	5.11
5.3.1 Separating Signals by Selecting the Resolution Bandwidth	5.11
5.3.1.1 Separating Two Signals with a Level of –30 dBm each at a Frequency Spacing of 30 kHz	5.12
5.3.1.2 Measuring the Modulation Depth of an AM-Modulated Carrier in the Frequency Domain	5.16
5.4 Measurements in the Time Domain	5.17
5.4.1 Measuring the Power Characteristic	5.18
5.4.1.1 Example – Measuring the Power of a GSM Burst During the Activation Phase.	5.18

5.4.2	Measuring the Power Characteristic of Burst Signals	5.20
5.4.2.1	Example - Measuring the Edges of a GSM Burst with High Time Resolution	5.20
5.4.3	Measuring the Signal-to-Noise Ratio of Burst Signals	5.23
5.4.3.1	Example - Signal-to-Noise Ratio of a GSM Signal	5.23
5.4.4	Measurement of AM-Modulated Signals	5.26
5.4.4.1	Example – Displaying the AF of an AM-Modulated Signal in the Time Domain	5.26
5.4.5	Measurement of FM-Modulated Signals	5.28
5.4.5.1	Example - Display of the AF of an FM-Modulated Carrier	5.28
5.5	Storing and Loading Instrument Settings	5.31
5.5.1	Storing an Instrument Configuration (without Traces)	5.31
5.5.1.1	Storing Traces	5.32
5.5.2	Loading an Instrument Configuration	5.32
5.5.2.1	Automatic Loading of a Data Record during Booting	5.33
5.6	Printing Out the Measurement Results	5.34
5.6.1	Selecting the Color Setting for the Printout	5.35
5.7	Additional Measurement Examples	5.35

This section provides a brief introduction on operating the R&S FSP Spectrum Analyzer. A more detailed discussion of the basic operating steps, e.g. selecting menus and setting parameters, plus measurement examples are provided in the Operating Manual, chapters 2 and 4.

5.1 Measuring a Sinusoidal Signal

One of the most common measurement tasks is determining the level and frequency of a signal. When measuring an unknown signal, you can usually start with the preset setting.



If levels higher than +30 dBm (=1 W) are expected or are possible, a power attenuator must be inserted before the RF input of the R&S FSP. If this is not done, signal levels exceeding 30 dBm can damage the RF attenuator or the input mixer. The total power of all signals that are present must be taken into account.

In the following examples, a signal generator is used as a signal source.

Test setup:

Connect the RF output of the signal generator to the RF input of R&S FSP.

Settings on the signal generator:

Frequency: 128 MHz

Level: -30 dBm

5.1.1 Measuring the Level and Frequency with Markers

The level and frequency of a sinusoidal signal can be measured easily by using the marker function. The R&S FSP always displays its amplitude and frequency at the marker position. The frequency measurement uncertainty is determined by the reference frequency of the R&S FSP, the resolution of the marker frequency display and the resolution of the screen.

5.1.1.1 Procedure

1. Reset the instrument.

- Press the *PRESET* key.

2. Connect the signal to be measured to the *RF INPUT* input on the instrument front panel.

3. Set the center frequency to 128 MHz.

- Press the *FREQ* key.
The entry field for the center frequency appears on screen.
- Using the numeric keypad in the input field, enter 128 and confirm the entry with the *MHz* key.

Measuring a Sinusoidal Signal

4. Reduce the frequency span (SPAN) to 1 MHz.

- Press the *SPAN* key.
- Using the numeric keypad in the input field, enter *1* and confirm the entry with the *MHz* key.



When the frequency span is defined, the resolution bandwidth (*RES BW*), the video bandwidth (*VIDEO BW*) and the sweep time (*SWEEP TIME*) are automatically reset, because these functions are linked in the preset setting.

5. Measure the level and frequency using the marker and read the results from the screen.

- Press the *MKR* key.
The marker is activated and automatically jumps to the maximum of the trace.



When a marker is initially activated, it automatically performs the peak search function (as shown in the example).

If a marker is already active, press the *PEAK* key in the *MKR->* menu in order to set the currently active marker to the maximum of the displayed signal.

The level and frequency values measured by the marker are displayed in the marker field at the top edge of the screen. They can be taken as the measurement result.

```
Marker 1 [T1]
      -30.00 dBm
      128.00000000 MHz
```

The field header indicates the number of the marker (*MARKER 1*) and the trace on which the marker is located ([*T1*] = Trace 1).

5.1.1.2 Increasing the Frequency Resolution

The frequency resolution of the marker is predefined by the measurement point resolution of the trace. A trace uses 501 measurement points, i.e. when the frequency span is 1 MHz, each measurement point corresponds to a span of approx. 2 kHz. This corresponds to a maximum uncertainty of 1 kHz.

You can increase the measurement point resolution of the trace by reducing the frequency span.

Reduce the frequency span (SPAN) to 10 kHz

- Press the *SPAN* key.
- Using the numeric keypad, enter *10* in the entry field and confirm the entry with the *kHz* key.

The generator signal is measured using a span of 10 kHz. The measurement point resolution of the trace is now approx. 20 Hz (10 kHz span /501 measurement points), i.e. the precision of the marker frequency display increases to approx. ± 10 Hz.

5.1.1.3 Setting the Reference Level

With analyzers, the reference level (*REF LEVEL*) is the level at the upper limit of the diagram. To achieve the widest dynamic range possible for a spectrum measurement, use the entire level span of the analyzer. In other words, the highest level that occurs in the spectrum must be located at the top edge of the diagram (=reference level) or immediately below it.



If the reference level that is selected is less than the highest signal that occurs in the spectrum, the signal path in the R&S FSP will be overloaded. In this case, the message *IFOVL* will appear on the left-hand edge of the diagram.

In the preset setting, the value of the reference level is -20 dBm. If the input signal is -30 dBm, the reference level can be reduced by 20 dB without causing the signal path to be overloaded.

1. Reduce the reference level by 10 dB.

- Press the *AMPT* key.
The *AMPT* menu will appear in the softkey bar. The *REF LEVEL* softkey will be highlighted in red to indicate that it is activated for data entry. The entry field for the reference level is also opened and displays a value of -20 dBm.
- Using the numeric keypad, enter *30* and confirm the entry with the *-dBm* key.
The reference level is now set to -30 dBm. The maximum of the trace is near the maximum of the measurement diagram. However, the increase in the displayed noise is not substantial. Thus, the distance between the signal maximum and the noise display (=dynamic range) has increased.

2. Setting the marker level equal to the reference level

The marker can also be used to shift the maximum value of the trace directly to the top edge of the diagram. If the marker is located at the maximum level of the trace (as in this example), the reference level can be moved to the marker level as follows:

- Press the *MKR->* key.
- Press the *REF LVL = MKR LVL* softkey.
The reference level will be set equal to the measured level where the marker is located.

Thus, setting the reference level is reduced to two keystrokes.

5.1.2 Measuring the Signal Frequency using the Frequency Counter

The built-in frequency counter makes it possible to measure the frequency more precisely than measuring it with the marker. The frequency sweep is stopped at the marker, and the R&S FSP measures the frequency of the signal at the marker position.

In the following example, the frequency of the generator at 128 MHz is shown by using the marker.

1. Reset the instrument.

- Press the *PRESET* key.
The R&S FSP is in the default state.

2. Set the center frequency and the span.

- Press the *FREQ* key and enter *128 MHz*.
The center frequency of the R&S FSP is set to 128 MHz.
- Press the *SPAN* softkey and enter *1 MHz*.
The frequency span of the R&S FSPs set to 1 MHz.

3. Activate the marker

- Press the *MKR* key.
The marker is activated and set to the signal maximum. The level and the frequency of the marker are displayed in the marker information field.

4. Activate the frequency counter.

- Press the *SIGNAL COUNT* softkey in the marker menu.
The result of frequency counting is displayed in the selected resolution (1 kHz in the default state) in the marker field at the top edge of the screen.

5. Set the resolution of the frequency counter to 1 Hz.

- Go to the right-hand side menu of the marker menu by pressing the *NEXT* key.
- Press the *CNT RESOL 1 Hz* softkey.

Measuring a Sinusoidal Signal

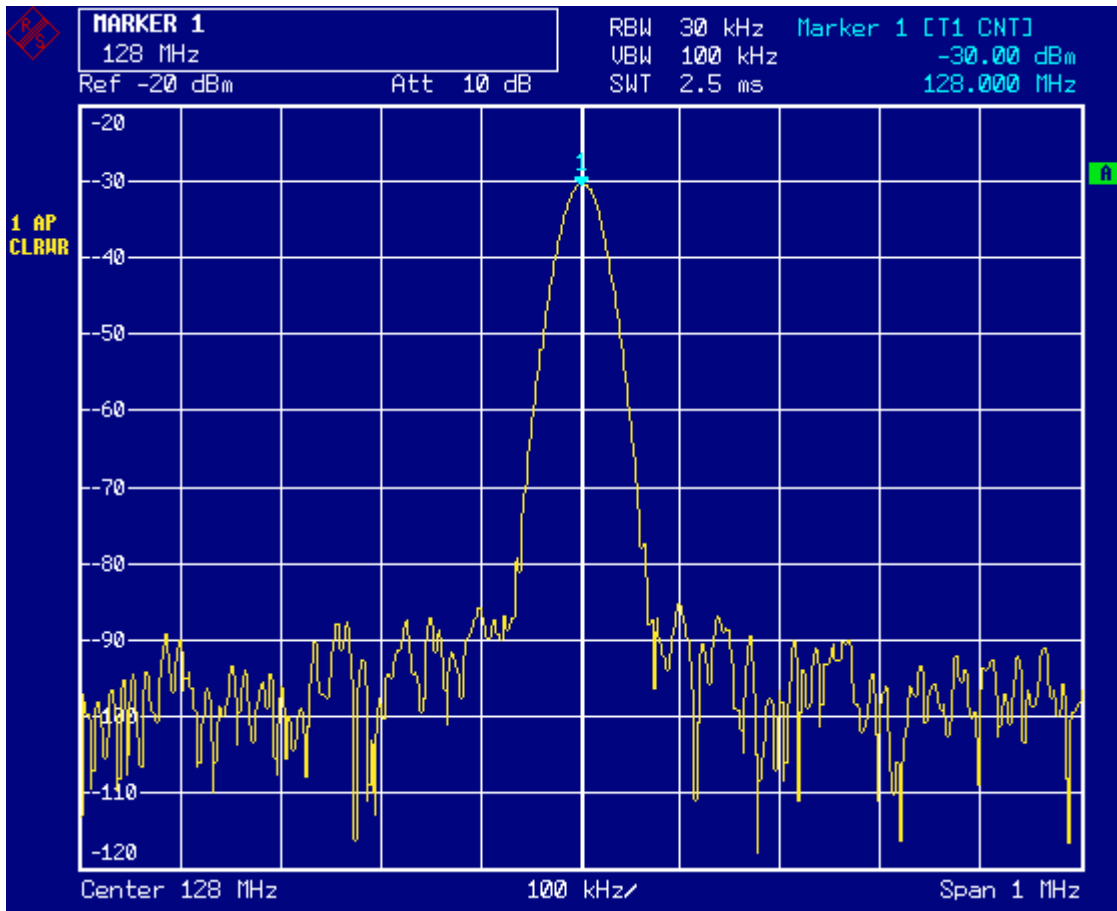

Fig. 5-1 Measurement of the frequency with the frequency counter



Obtaining a correct result when measuring the frequency with the internal frequency counter requires that an RF sinusoidal signal or a spectral line be present. The marker must be located more than 25 dB above the noise level to ensure that the specified measurement accuracy is adhered to.



For bandwidths between 300 kHz and 10 MHz, the time for measuring the frequency is inversely proportional to the selected resolution, i.e. a resolution of 1 Hz requires a gate time of 1 second for the counter.

For digital bandwidths of less than 300 kHz, the time for measuring the frequency is always approx. 30 ms and is not affected by the resolution that is set.

Thus, when measuring the frequency of a sinusoidal carrier that has high resolution, set the resolution bandwidth to 100 kHz or less.

Measuring Harmonics of Sinusoidal Signals

5.2 Measuring Harmonics of Sinusoidal Signals

Measuring the harmonics of a signal is a very common task that can be optimally performed by using an analyzer.

In the following example, the generator signal with 128 MHz and -30 dBm is used again.

5.2.1 Measuring the Suppression of the First and Second Harmonic of an Input Signal

1. Reset the instrument.

- Press the *PRESET* key.
The R&S FSP is now in the default state.

2. Set the start frequency to 100 MHz and the stop frequency to 400 MHz.

- Press the *FREQ* key.
- Press the *START* softkey and enter *100 MHz*.
- Press the *STOP* softkey and enter *400 MHz*.
The R&S FSP displays the fundamental and the first and second harmonics of the input signal.

3. For maximum sensitivity, set the RF attenuation to 0 dB.

- Press the *AMPT* key.
- Press the *RF ATTEN MANUAL* softkey and enter *0 dB*.

4. To average (suppress) the noise, reduce the video bandwidth.

- Press the *BW* key.
- Press the *COUPLING RATIO* softkey.
- Using the arrow keys, select *RBW/VBW NOISE [10]*.

The video bandwidth (VBW) will now always be set to less than the resolution bandwidth (RBW) by a factor of 10.

5. Activate the marker.

- Press the *MKR* key.
Marker 1 will be activated and positioned to the signal maximum (fundamental at 128 MHz). The level and frequency of the marker will be displayed in the marker information field.

6. Activate the delta marker and measure the harmonic suppression.

- Press the *MARKER 2* softkey in the marker menu.
Marker 2 will be activated as the delta marker (Delta 2 [T1]). It automatically appears on the largest harmonic of the signal. The frequency offset and level offset from marker 1 are displayed in the marker field at the top edge of the screen.

Measuring Harmonics of Sinusoidal Signals

- Press the **MARKER 3** softkey in the marker menu. Marker 3 is activated as the delta marker (Delta 3 [T1]). It automatically appears on the next largest harmonic of the signal. The frequency offset and level offset from marker 1 on the fundamental are displayed in the marker field at the top edge of the screen. (see Fig. 5-2)

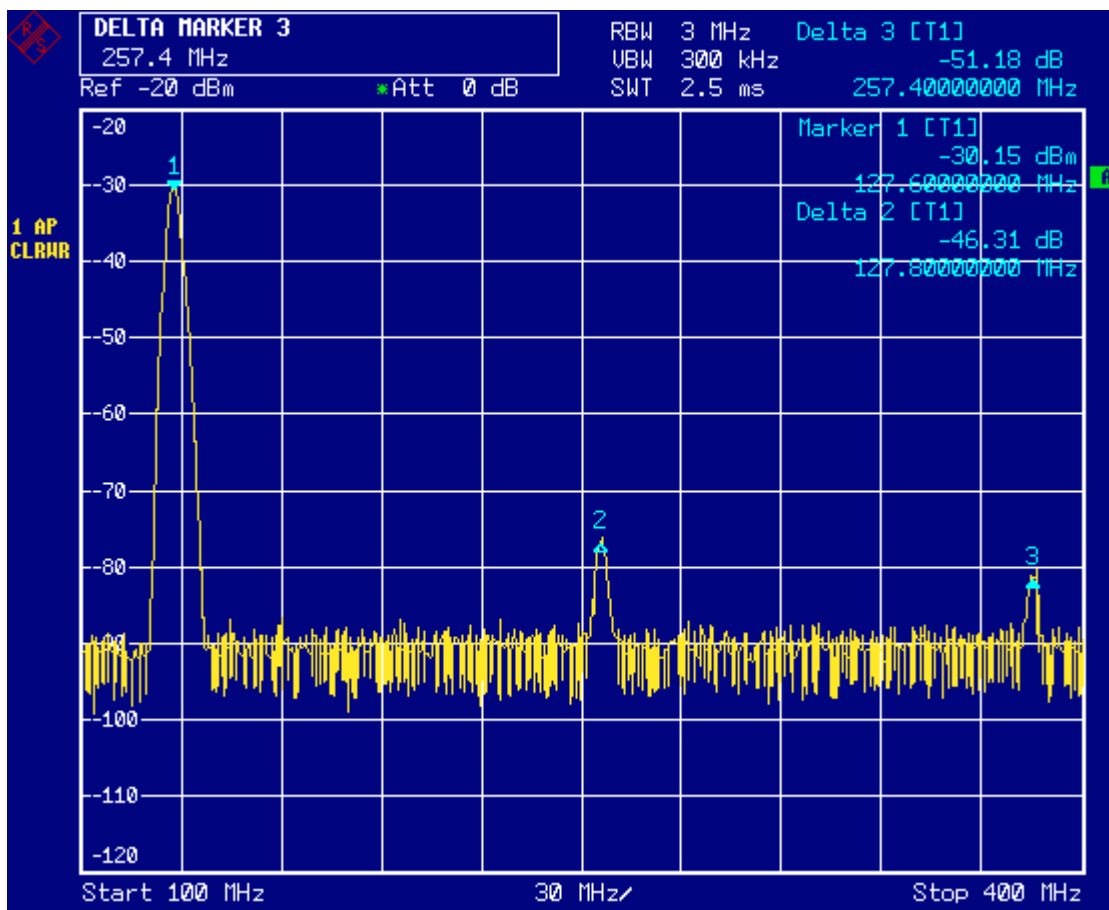

Fig. 5-2 Measuring the harmonic suppression of the internal reference generator. Markers delta 2 [T1] and delta 3 [T1] show the offset of the first and second harmonics from the fundamental.

5.2.2 Reducing Noise

The R&S FSP offers three means of effectively differentiating the harmonics of a signal from the noise:

- Reducing the video bandwidth
- Averaging the trace
- Reducing the resolution bandwidth

Reducing the video bandwidth and averaging the traces cause the noise from the R&S FSP or the DUT to be reduced, depending on which component is larger. Both averaging methods reduce the measurement uncertainty particularly in the case of small signal-to-noise ratios, because the measurement signal is also separated from the noise.

Measuring Harmonics of Sinusoidal Signals

1. Reducing the noise by reducing the video bandwidth.

- Press the *BW* key.
- Press the *VIDEO BW MANUAL* softkey.
- Using the rotary knob (turning it counterclockwise), reduce the video bandwidth to 10 kHz (for example), or enter *10 kHz*.

This clearly smooths the noise, and the sweep time will increase to 25 ms. In other words, the measurement will clearly take more time. The video bandwidth that is shown in the display is marked with an asterisk (*VBW) to indicate that it is no longer coupled to the resolution bandwidth (see Fig. 5-3).

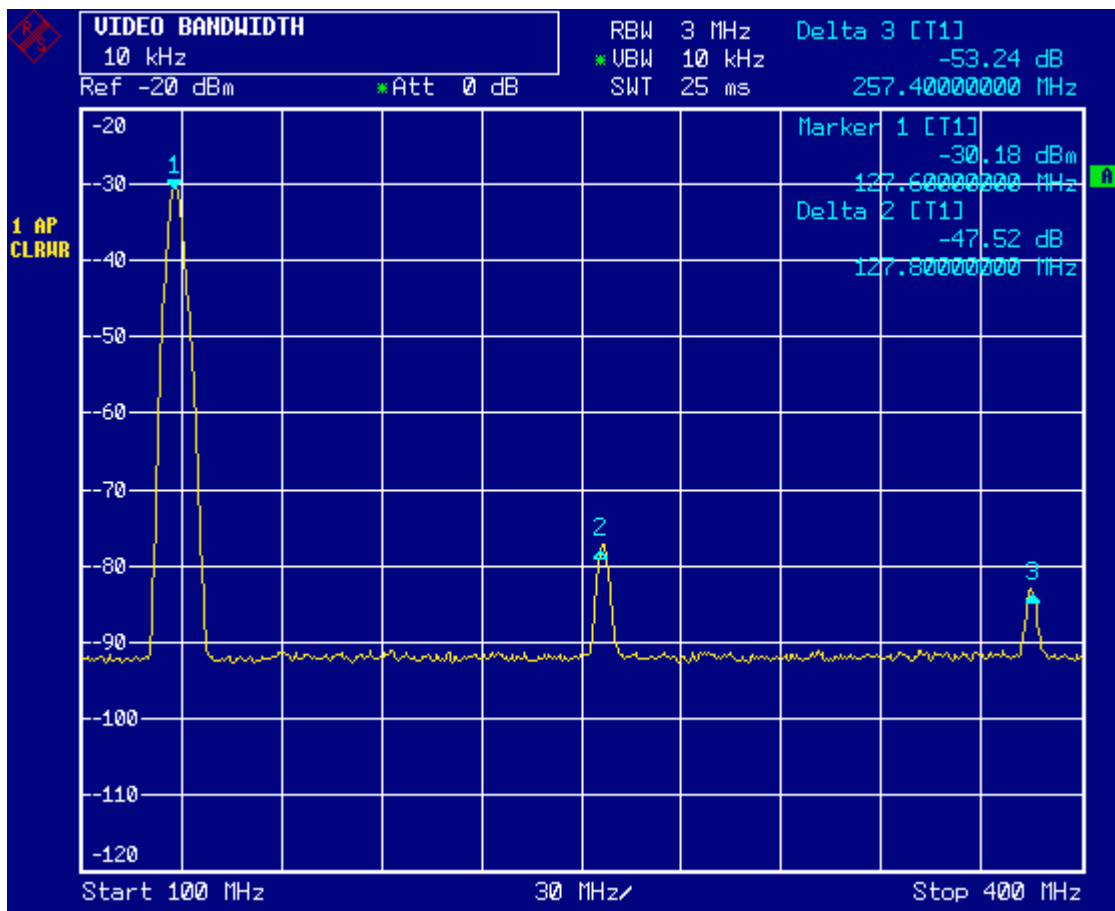

Fig. 5-3 Suppression of noise during harmonics measurement by reducing video bandwidth

2. Recouple the video bandwidth to the resolution bandwidth.

- Press the *VIDEO BW AUTO* softkey.

3. Reduce the noise by averaging the curve.

- Press the *TRACE* key.
- Press the *AVERAGE* softkey.

The noise component of the trace will be smoothed by averaging 10 successive traces.

Measuring Signal Spectra with Multiple Signals

4. Switch off trace averaging.

- Press the *CLEAR/WRITE* softkey.

5. Reduce the noise by reducing the measurement bandwidth.

The noise is reduced in proportion to the bandwidth by reducing the resolution bandwidth, i.e. reducing the resolution bandwidth by a factor of 10 also reduces the noise by a factor of 10 (which corresponds to 10 dB). The amplitude of sinusoidal signals is not affected by reducing the resolution bandwidth.

6. Set the resolution bandwidth to 10 kHz.

- Press the *BW* key.
- Press the *RES BW MANUAL* softkey and enter *10 kHz*.
The noise decreases by approx. 25 dB with respect to the previous setting. Since the video bandwidth is coupled to the resolution bandwidth, it is reduced to 1 kHz in proportion to the resolution bandwidth. This causes the sweep time to increase to 60 seconds.

7. Reset the resolution bandwidth (couple it to the span)

- Press the *RES BW AUTO* softkey.

5.3 Measuring Signal Spectra with Multiple Signals

5.3.1 Separating Signals by Selecting the Resolution Bandwidth

A basic feature of an analyzer is being able to separate the spectral components of a mixture of signals. The resolution at which the individual components can be separated is determined by the resolution bandwidth. Selecting a resolution bandwidth that is too large may make it impossible to distinguish between spectral components, i.e they will appear as a single component.

An RF sinusoidal signal will be shown on the screen by means of the passband characteristic of the resolution filter (RBW) that has been set. Its specified bandwidth is the 3 dB bandwidth of the filter.

Two signals with the same amplitude can be resolved if the resolution bandwidth is smaller than or equal to the frequency spacing of the signals. If the resolution bandwidth is equal to the frequency spacing, the spectrum display screen will show a level drop of 3 dB precisely in the center of the two signals. Decreasing the resolution bandwidth makes the level drop larger, which thus makes the individual signals clearer.

The trade-off for higher spectral resolution at a narrower bandwidth is longer sweep times at the same span. Reducing the resolution bandwidth by a factor of 3 increases the sweep time by a factor of 9.

Measuring Signal Spectra with Multiple Signals

5.3.1.1 Separating Two Signals with a Level of -30 dBm each at a Frequency Spacing of 30 kHz

Test setup:

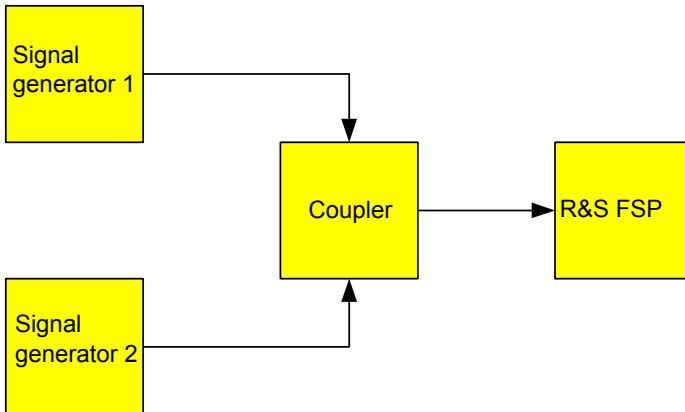

Setting the signal generators:

	Level	Frequency
Signal generator 1	-30 dBm	100.00 MHz
Signal generator 2	-30 dBm	100.03 MHz

Operating steps on the R&S FSP:

1. Reset the instrument.

- Press the *PRESET* key.
The R&S FSP is now in the default state.

2. Set the center frequency to 100.015 MHz and the frequency span (SPAN) to 300 kHz.

- Press the *FREQ* key and enter 100.015 MHz.
- Press the *SPAN* key and enter 300 kHz.

3. Set the resolution bandwidth to 30 kHz and the video bandwidth to 1 kHz.

- Press the *BW* key.
- Press the *RES BW MANUAL* softkey and enter 30 kHz.
- Press the *VIDEO BW MANUAL* softkey and enter 1 kHz.
- The two signals can be clearly distinguished by a 3 dB level drop in the center of the screen.

Measuring Signal Spectra with Multiple Signals



The video bandwidth is set to 1 kHz in order to make the level drop in the center of the two signals clearly visible. At larger video bandwidths, the video voltage that results from envelope detection is not sufficiently suppressed. This produces additional voltages, which are visible in the trace, in the transition area between the two signals.

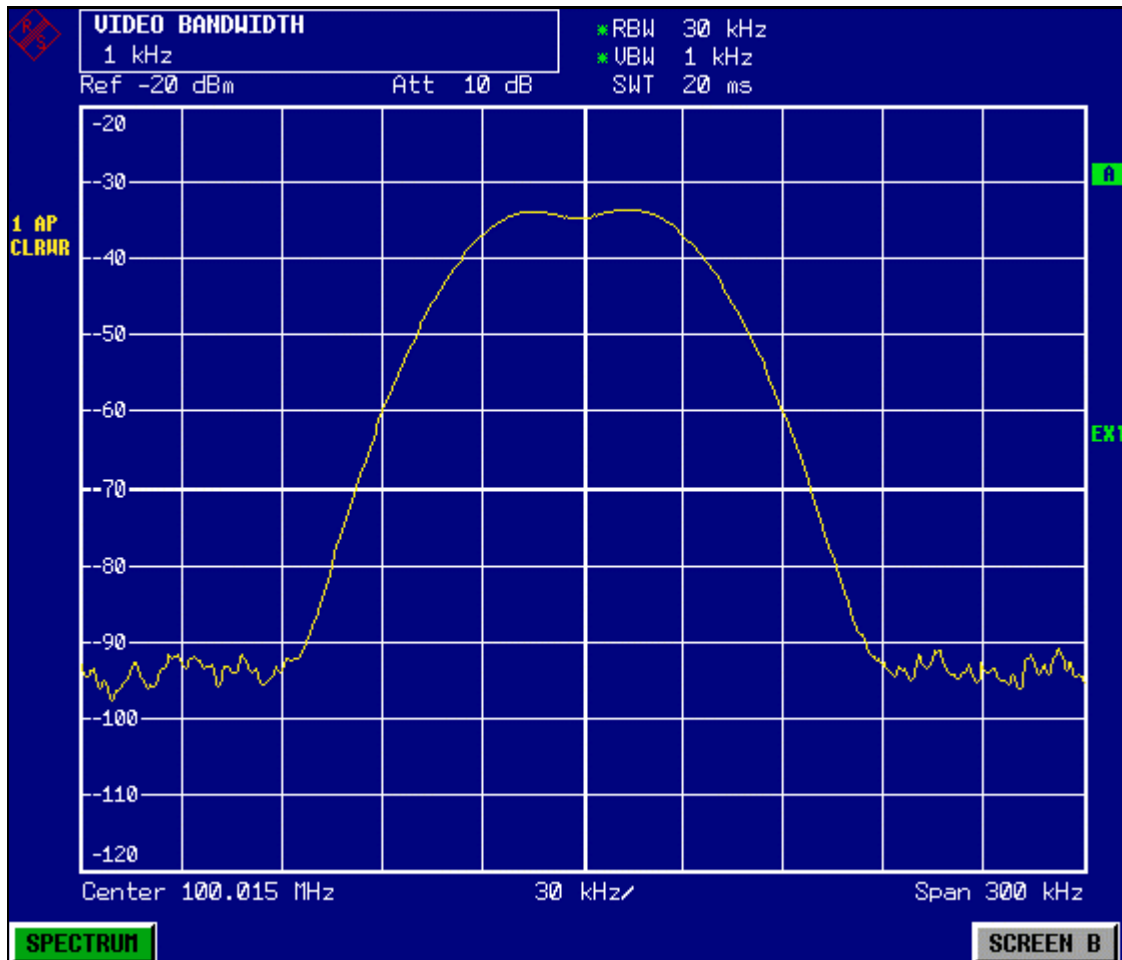

Fig. 5-4 Measurement of two equally-sized RF sinusoidal signals with the resolution bandwidth which corresponds to the frequency spacing of the signals.



The level drop is located exactly in the center of the screen only if the generator frequencies exactly match the frequency display of the R&S FSP. To achieve exact matching, the frequencies of the generators and the R&S FSP must be synchronized.

Measuring Signal Spectra with Multiple Signals

4. Set the resolution bandwidth to 100 kHz.

- Press the *RES BW MANUAL* softkey and enter 100 kHz.
It is no longer possible to clearly distinguish the two generator signals.

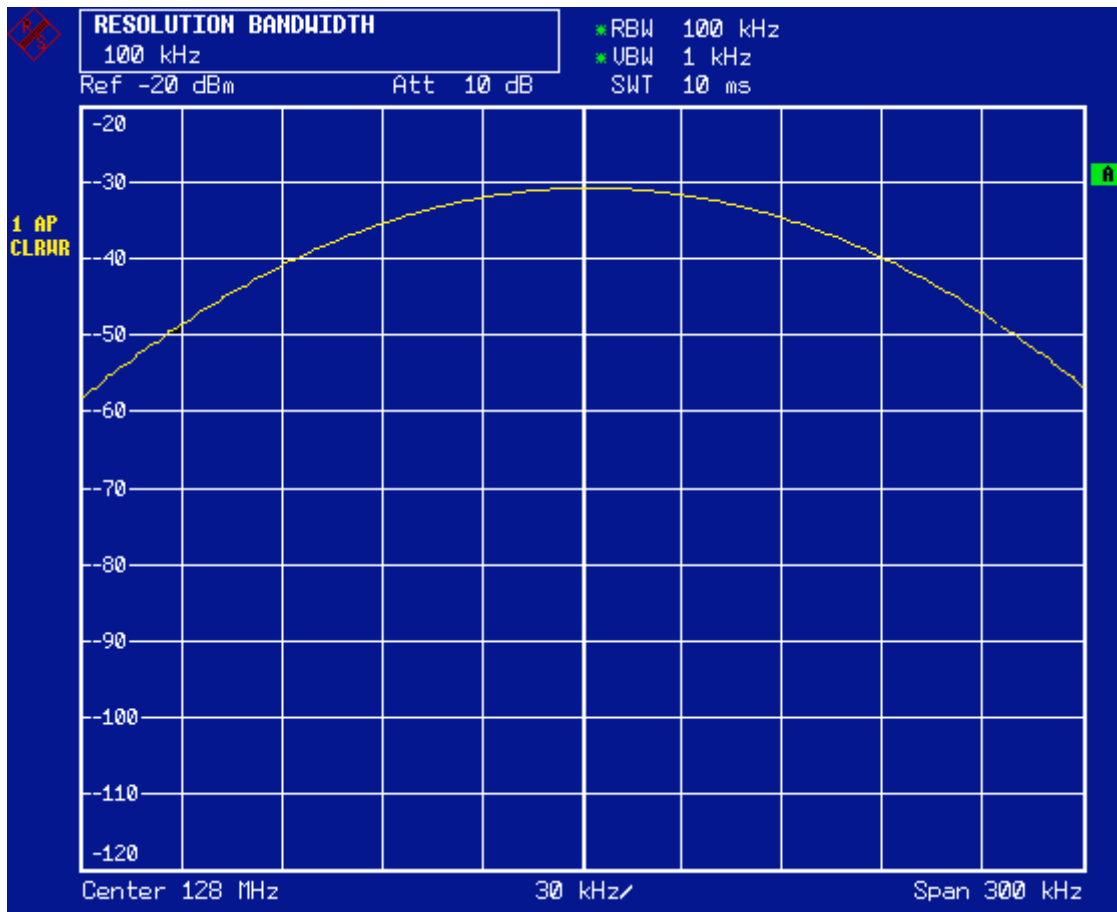

Fig. 5-5 Measurement of two equally-sized RF sinusoidal signals with a resolution bandwidth which is larger than their frequency spacing.

The resolution bandwidth (RBW) can be reduced again by turning the rotary knob counterclockwise, thus yielding a higher frequency resolution.

Measuring Signal Spectra with Multiple Signals

5. Set the resolution bandwidth to 1 kHz.

- Turn the rotary knob counterclockwise until the bandwidth indicates 1 kHz. The two generator signals are shown with high resolution. However, the sweep time becomes noticeably longer (600 ms), since it increases at a rate of $1/\text{RBW}^2$. At smaller bandwidths (10 dB per a bandwidth factor of 10), the noise display decreases simultaneously.

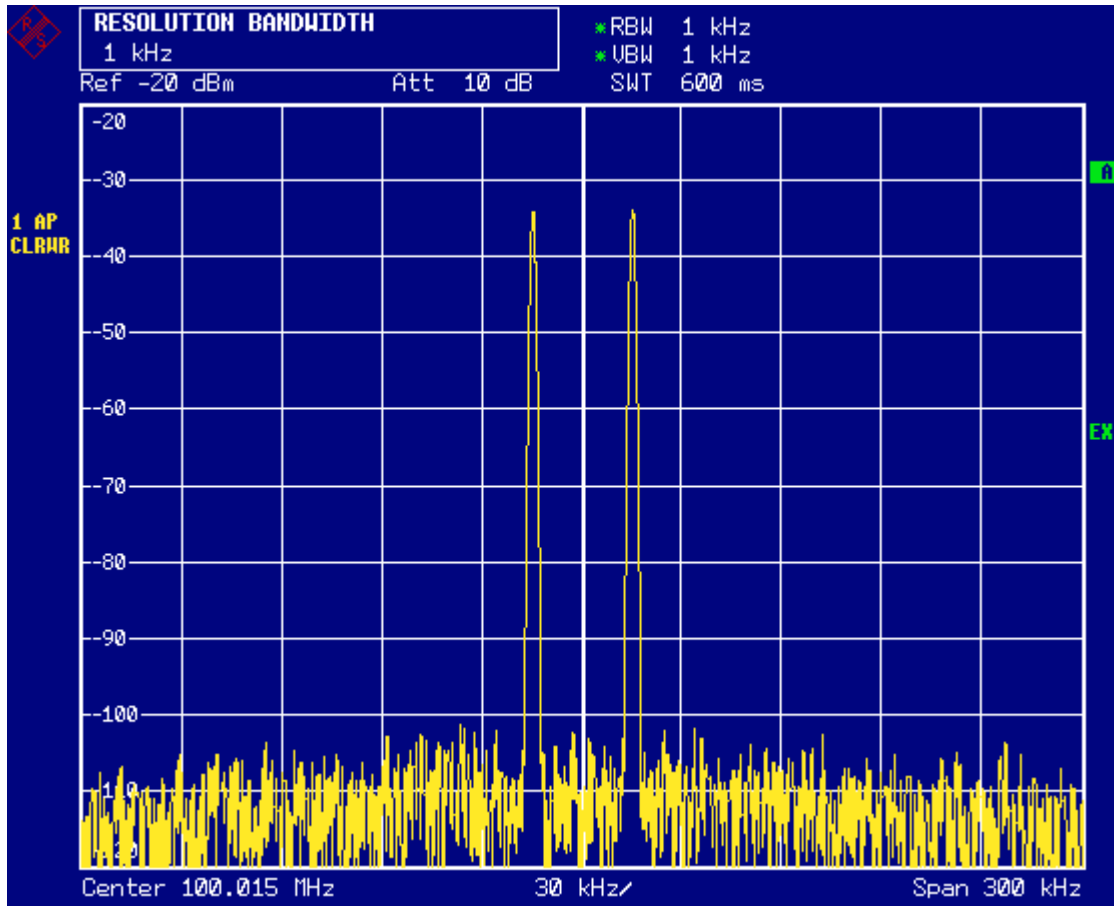

Fig. 5-6 Measurement of two RF equally-sized sinusoidal signals with a resolution bandwidth (1 kHz) which is clearly smaller than their frequency spacing.

6. Activate the FFT bandwidths.

- Using the *FILTER TYPE* softkey in the selection list, set the filter type to *FFT*. IF filtering is now performed using the FFT algorithm. The sweep time decreases significantly from 600 ms to 15 ms (a factor of 40). The display update rate also increases by almost the same ratio.

Measuring Signal Spectra with Multiple Signals

5.3.1.2 Measuring the Modulation Depth of an AM-Modulated Carrier in the Frequency Domain

In the frequency range (scan) display, the AM side bands can be resolved with a narrow bandwidth and measured separately. The modulation depth of a carrier modulated with a sinusoidal signal can then be measured. Since the dynamic range of an analyzer is very large, extremely small modulation depths can also be measured precisely. For this purpose, the R&S FSP provides measurement routines that directly output the modulation depth numerically in %.

Test setup:

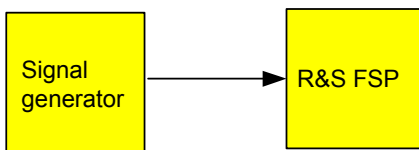

Settings on the signal generator (e.g. R&S SMIQ):

Frequency: 100 MHz
Level: -30 dBm
Modulation: 50% AM, 1 kHz AF

Measurement with the R&S FSP:

1. Reset the instrument.

- Press the *PRESET* key.
The R&S FSP is now in the default state.

2. Set the center frequency to 100 MHz and span to 5 Hz.

- Press the *FREQ* key and enter 100 MHz.
- Press the *SPAN* key and enter 5 kHz.

3. Activate the marker function for measuring the AM modulation depth.

- Press the *MEAS* key.
- Press the *MODULATION DEPTH* softkey.
The R&S FSP automatically sets a marker to the carrier signal in the center of the diagram and one delta marker each to the upper and lower AM sidebands. The R&S FSP calculates the AM modulation depth from the level differences of the delta markers to the main marker and outputs the numeric value in the marker information field.

Measurements in the Time Domain



Fig. 5-7 Measurement of the AM modulation depth. The modulation depth shown is MDEPTH. The frequency of the AF signal can be obtained from the frequency display of the delta marker.

5.4 Measurements in the Time Domain

In the case of radio transmission systems that use the TDMA method (e.g. GSM or IS136), transmission quality is determined not only by spectral characteristics but also by characteristics in the time domain. However, a timeslot is assigned to each user since several users share the same frequency. Smooth operation is ensured only if all users adhere exactly to their assigned timeslots.

Both the power during the send phase as well as the timing and duration of the TDMA burst and rise and fall times of the burst are important.

5.4.1 Measuring the Power Characteristic

For measuring power in the time domain, the R&S FSP offers easy-to-use functions that measure the power over a predefined time.

5.4.1.1 Example – Measuring the Power of a GSM Burst During the Activation Phase.

Test setup:

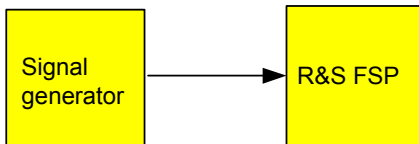

Settings on the signal generator (e.g. R&S SMIQ):

Frequency: 100 MHz
Level: 0 dBm
Modulation: GSM, one timeslot activated

Measurement with the R&S FSP:

1. Reset the instrument.

- Press the *PRESET* key.
The R&S FSP is now in the default state.

2. Set the center frequency to 100 MHz, the span to 0 Hz and the resolution bandwidth to 1 MHz.

- Press the *FREQ* key and enter 100 MHz.
- Press the *SPAN* key and enter 0 Hz, or press the *ZEROSPAN* softkey.

3. Set the reference level of the R&S FSP to 10 dBm (= level of the signal generator +10 dB).

- Press the *AMPT* key and enter 10 dBm.

4. Set the sweep time to 1 ms.

- Press the *SWEEP* key and enter 1 ms.
The R&S FSP will show the GSM burst continuously across the display.

5. By using the video trigger, elicit triggering on the rising edge of the burst.

- Press the *TRIG* key.

Measurements in the Time Domain

- Press the *VIDEO* softkey and enter 70%.
The R&S FSP shows a static image with the GSM burst at the start of the trace. The trigger level is displayed as a horizontal line labelled with the absolute level for the trigger threshold in the measurement diagram.

6. Configure power measurement in the time domain.

- Press the *MEAS* key.
- Press the *TIME DOM POWER* softkey.
- Set the *LIMITS* softkey to *ON*.
- Press the *START LIMIT* softkey.
- By turning the rotary knob clockwise, move the vertical line to the start of the burst.
- Press the *STOP LIMIT* softkey.
- By turning the rotary knob counterclockwise, set the second vertical line to the end of the burst.
The R&S FSP will output on screen the average (mean) power during the activation phase of the burst.

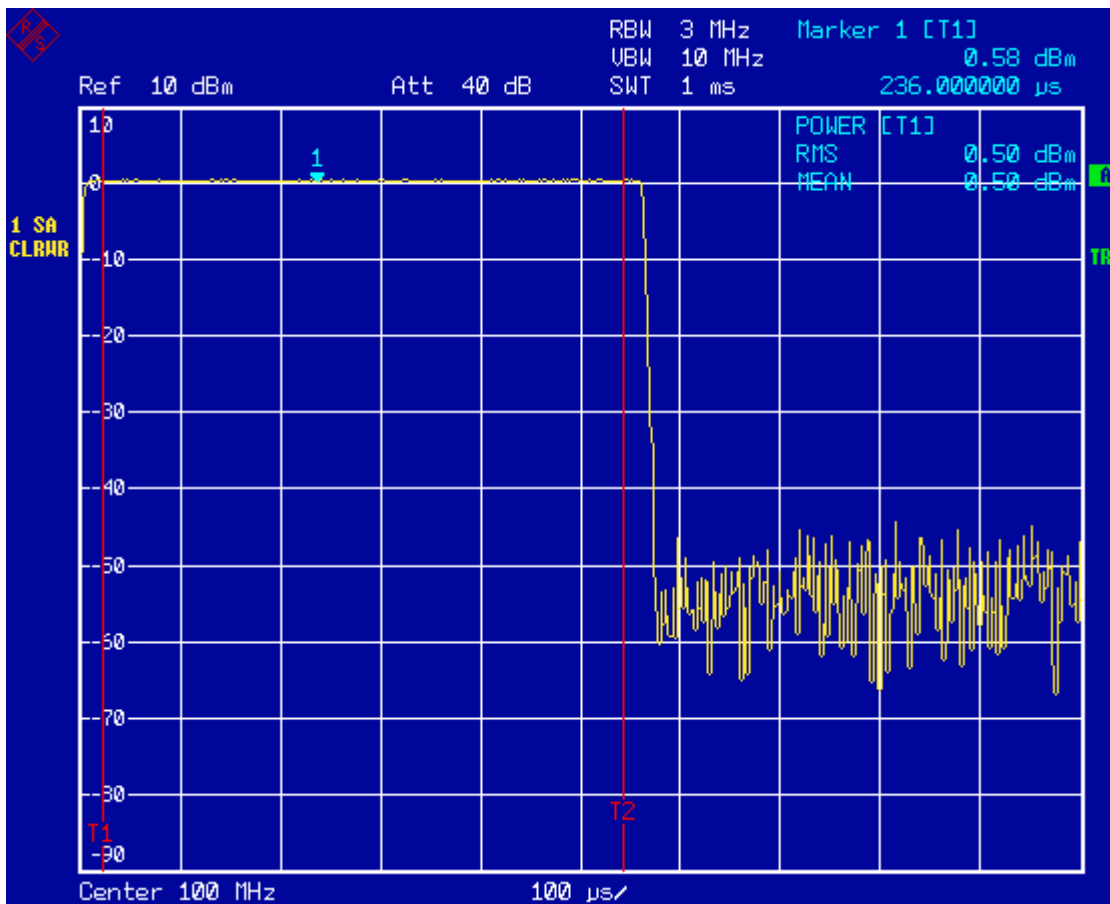

Fig. 5-8 Measurement of the average power during the activation phase of a GSM burst.

5.4.2 Measuring the Power Characteristic of Burst Signals

Because of the high time resolution of the R&S FSP at the 0 Hz display range, the edges of TDMA bursts can be measured precisely. The edges can be shifted to the screen area by using the trigger offset.

5.4.2.1 Example - Measuring the Edges of a GSM Burst with High Time Resolution

Test setup:

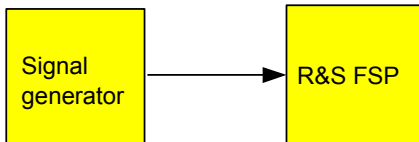

Settings on the signal generator (e.g. R&S SMIQ):

Frequency: 100 MHz
Level: 0 dBm
Modulation: GSM, one timeslot activated

Measurement with the R&S FSP:

The measurement is based on the setting in section “[Example – Measuring the Power of a GSM Burst During the Activation Phase.](#)” on page 5.18.

1. Switch off the power measurement.

- Press the *MEAS* key.
- Press the *TIME DOM POWER* softkey.
- In the submenu, set the *POWER* softkey to *OFF*.

2. Increase the time resolution to 100 μ s.

- Press the *SWEEP* key and enter 100 μ s.

3. Using the trigger softkey, shift the rising edge of the GSM burst to the center of the screen.

- Press the *TRIG* key.
- Press the *TRIGGER OFFSET* softkey.
- By turning the rotary knob counterclockwise, move the trigger offset until the burst edge can be seen in the center of the screen, or enter -50 μ s.
The R&S FSP will show the rising edge of the GSM burst.

Measurements in the Time Domain

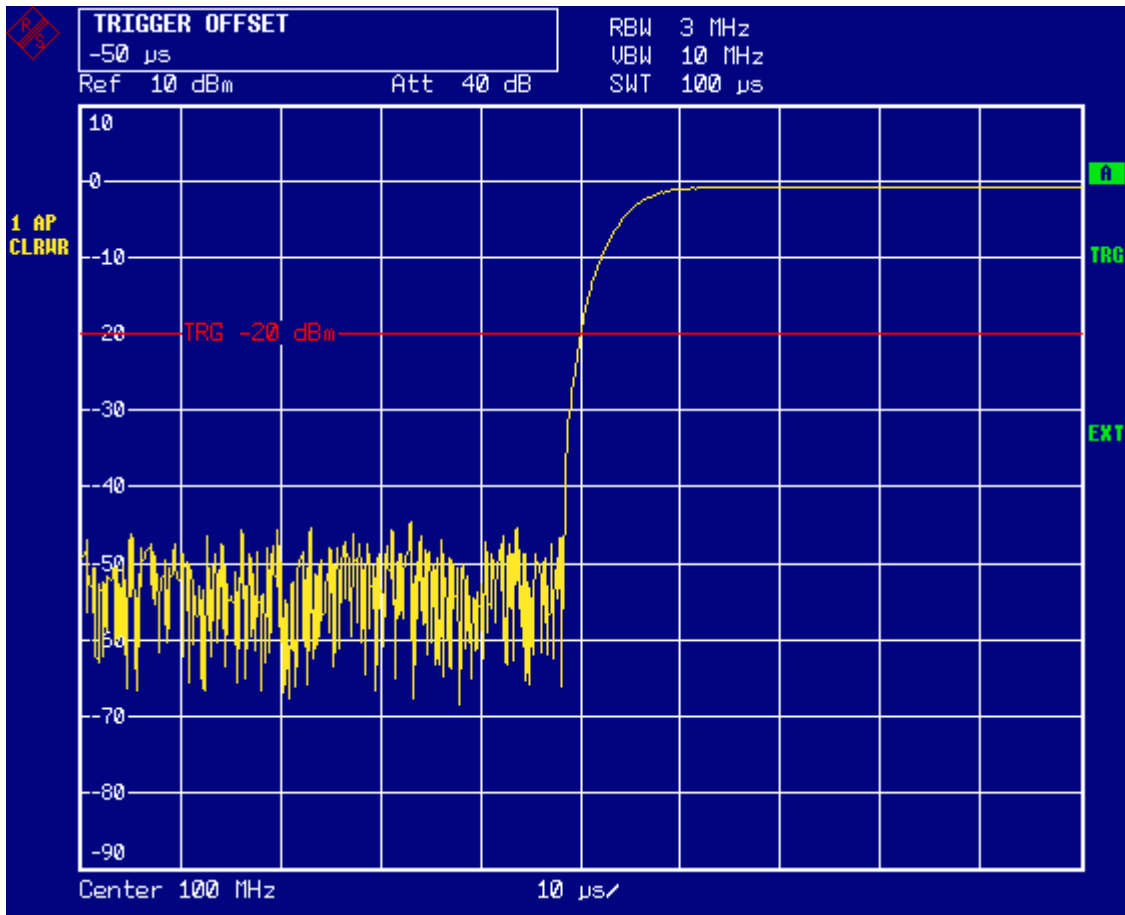

Fig. 5-9 Rising edge of the GSM burst displayed with high time resolution.

4. Using the trigger offset, move the falling edge of the burst to the center of the screen.

➤ Set the *POLARITY* softkey to *NEG*.

The R&S FSP will show the falling edge of the GSM burst.

Measurements in the Time Domain

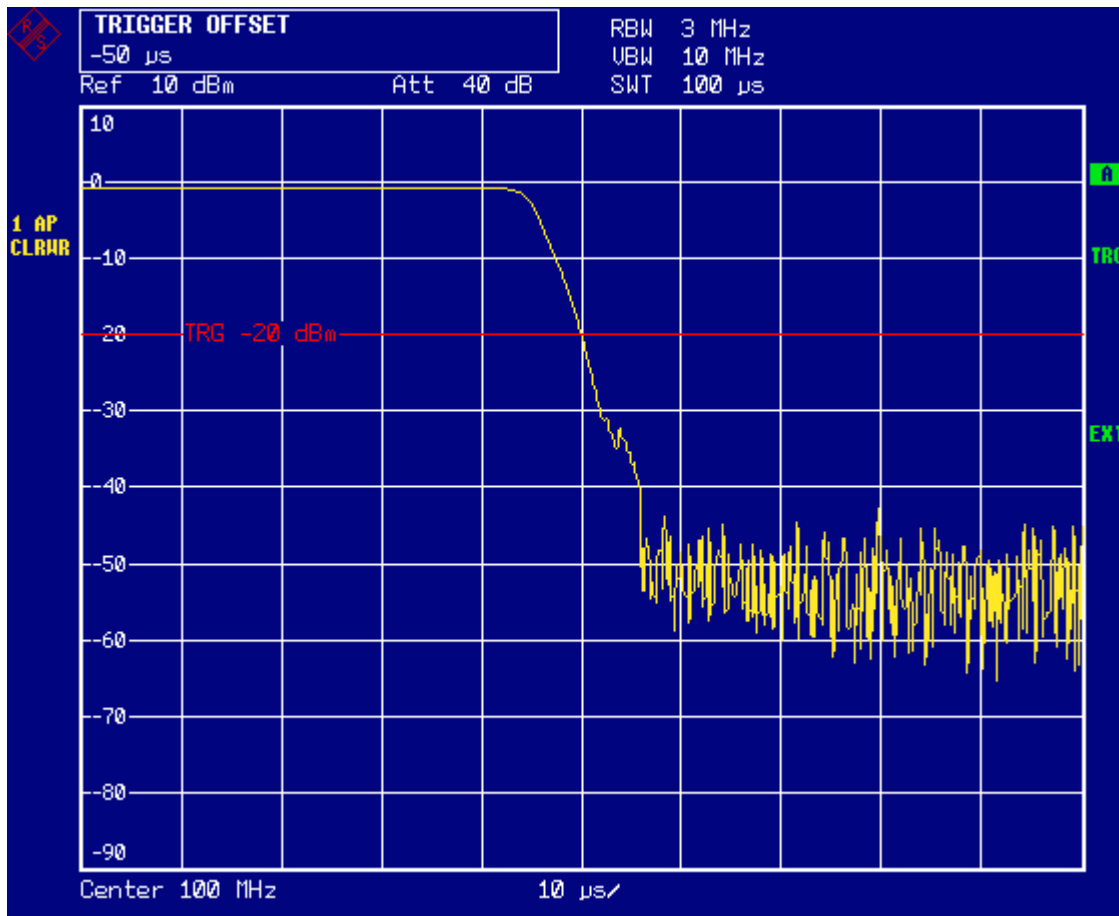

Fig. 5-10 Falling edge of the GSM burst displayed with high time resolution.

5.4.3 Measuring the Signal-to-Noise Ratio of Burst Signals

When TDMA transmission methods are used, the signal-to-noise ratio or the deactivation dynamic range can be measured by comparing the power values during the activation phase and the deactivation phase of the transmission burst. For this purpose, the R&S FSP provides the function for measuring absolute and relative power in the time domain. In the following example, the measurement is performed using a GSM burst.

5.4.3.1 Example - Signal-to-Noise Ratio of a GSM Signal

Test setup:

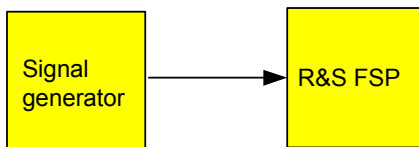

Settings on the signal generator (e.g. R&S SMIQ):

Frequency: 100 MHz
Level: 0 dBm
Modulation: GSM, one timeslot activated

Measurement with the R&S FSP:

1. Reset the instrument.

- Press the *PRESET* key.
The R&S FSP is now in the default state.

2. Set the center frequency to 100 MHz, the span to 0 Hz and the resolution bandwidth to 1 MHz.

- Press the *FREQ* key and enter 100 MHz.
- Press the *SPAN* key and enter 0 Hz or
- Press the *ZEROSPAN* softkey.
- Press the *BW* key and enter 1 MHz.

3. Set the reference level of the R&S FSP to 0 dBm (= level of the signal generator) and RF attenuation to 10 dB for maximum sensitivity.

- Press the *AMPT* key and enter 0 dBm.
- Press the *RF ATTEN MANUAL* softkey and enter 10 dB.

4. Set the sweep time to 2 ms.

- Press the *SWEEP* key and enter 2 ms.
The R&S FSP shows the GSM burst continuously across the display.

Measurements in the Time Domain

5. **By using the video trigger, elicit triggering on the rising edge of the burst and shift the start of burst to the center of the screen.**

- Press the *TRIG* key.
- Press the *VIDEO* softkey and enter 70%.
The R&S FSP shows a static image with the GSM burst at the start of the trace.
- Press the *TRIGGER OFFSET* softkey and enter -1 ms.
The R&S FSP shows the GSM burst in the right-hand half of the measurement diagram.

6. **Configure the power measurement in the time domain.**

- Press the *MEAS* key.
- Press the *TIME DOM POWER* softkey.
- Set the *LIMITS* softkey to *ON*.
- Press the *START LIMIT* softkey.
- Using the rotary knob, move the vertical line to the start of the burst.
- Press the *STOP LIMIT* softkey.
- Using the rotary knob, move the second vertical line to the end of the burst.
The R&S FSP outputs on screen the power during the activation phase of the burst.

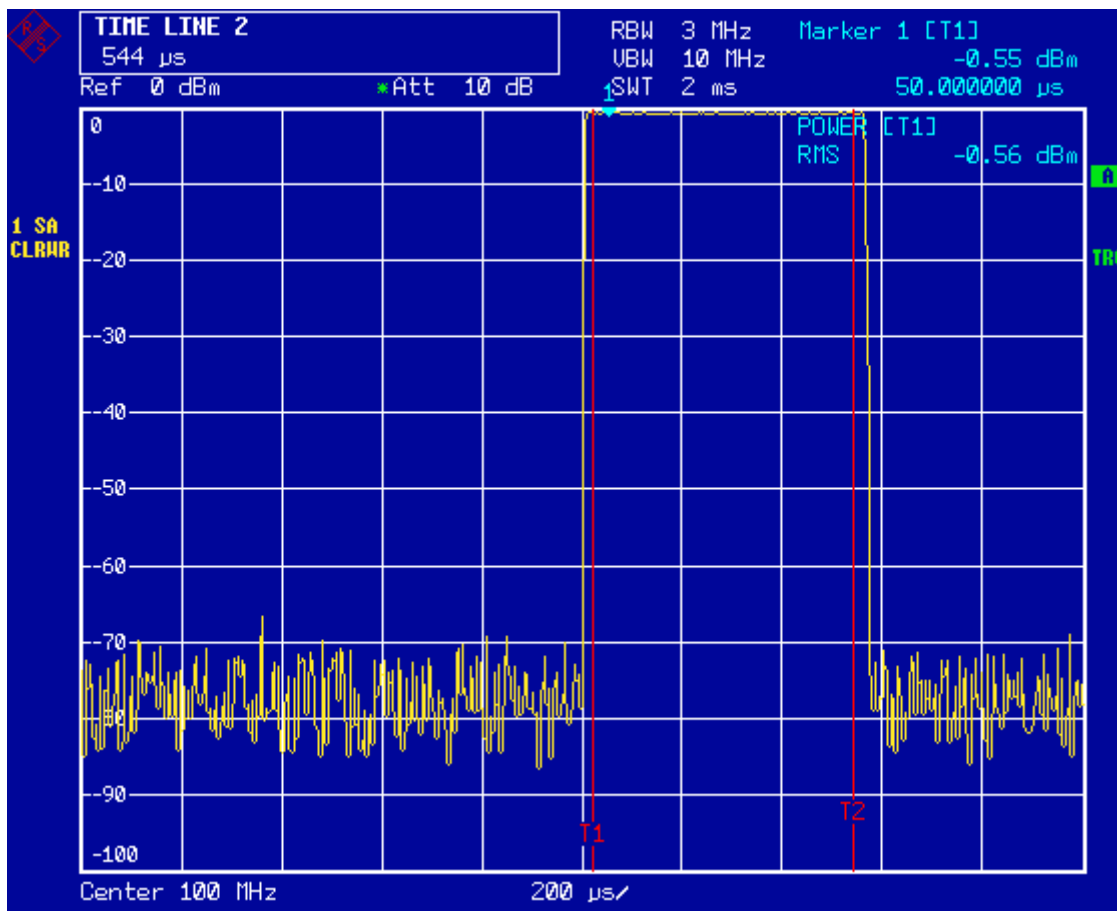

Fig. 5-11 Power measurement during the activation phase of the burst

Measurements in the Time Domain

7. Set the measured power as the reference and activate relative power measurement.

- Press the *NEXT* key.
The side menu for setting the power measurement will open.
- Set the *POWER ABS/REL* softkey to *REL*.
The power relative to the power during the activation phase of the burst is displayed.
- Press the *SET REFERENCE* softkey.
The measured power of the GSM burst is set as the reference.

8. Measure the power during the deactivation phase of the burst.

- Press the *TRIG* key.
- Set the *POLARITY POS/NEG* softkey to *NEG*.
The R&S FSP initiates triggering in response to the falling edge of the burst. This shifts the burst to the left-hand half of the measurement diagram. The power is measured in the deactivation phase. The start of the burst is shifted to the center of the screen and the power during the deactivation phase is measured relative to the reference power (= burst power).

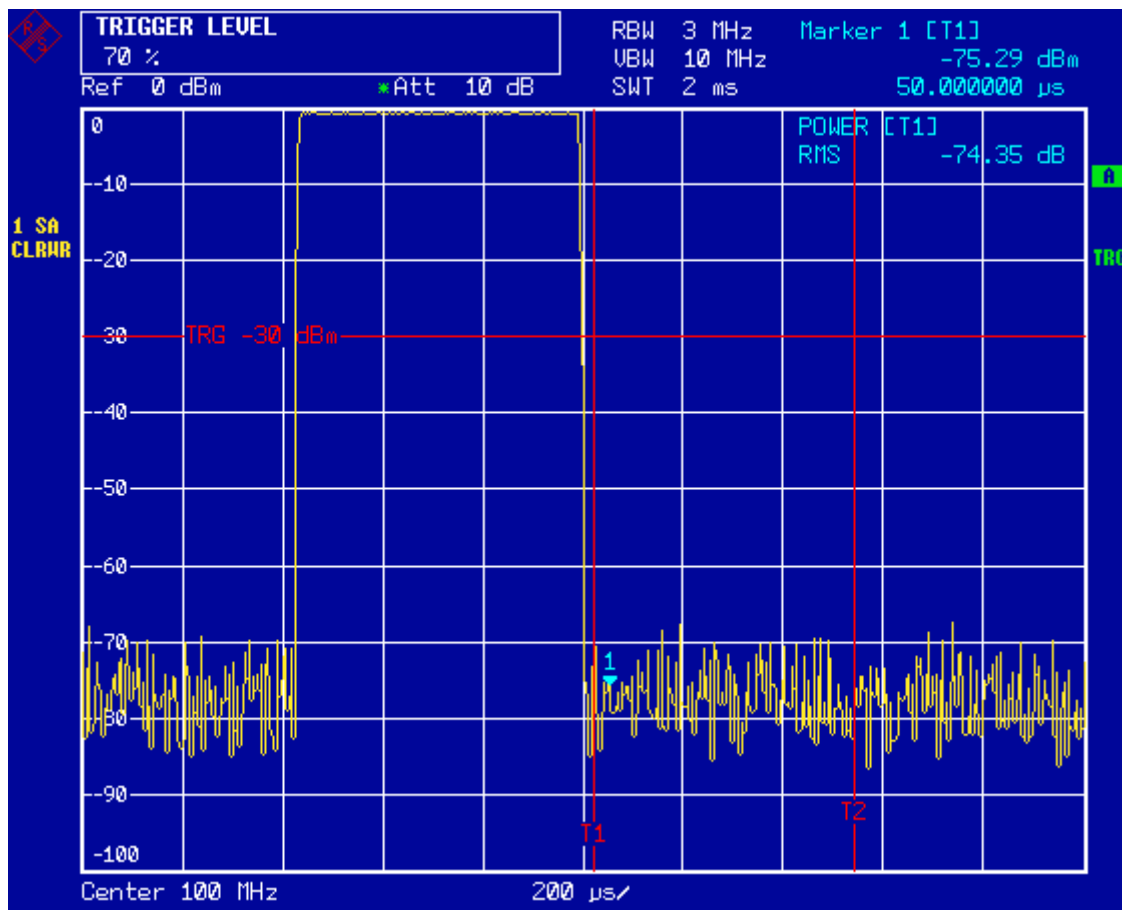

Fig. 5-12 Measurement of the signal-to-noise ratio of a GSM burst signal in the time domain

5.4.4 Measurement of AM-Modulated Signals

The R&S FSP rectifies the RF input signal and displays it as a magnitude spectrum. The rectification also demodulates AM-modulated signals. The AF voltage can be displayed in the time domain if the modulation sidebands fall within the resolution bandwidth.

5.4.4.1 Example – Displaying the AF of an AM-Modulated Signal in the Time Domain

Test setup:

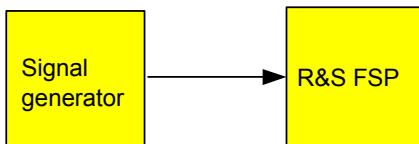

Settings on the signal generator (e.g. R&S SMIQ):

Frequency: 100 MHz
Level: 0 dBm
Modulation: 50% AM, 1 kHz AF

Measurement with the R&S FSP:

1. Reset the instrument.

- Press the *PRESET* key.
The R&S FSP is now in the default state.

2. Set the center frequency to 100 MHz and the span to 0 Hz.

- Press the *FREQ* key and enter 100 MHz.
- Press the *SPAN* key and enter 0 Hz.

3. Set the reference level to +6 dBm and the display range to linear.

- Press the *AMPT* key and enter 6 dBm.
- Press the *RANGE LINEAR* softkey.

4. Elicit triggering in response to the AF signal by using the video trigger to produce a static image.

- Press the *TRIG* key.
- Press the *VIDEO* softkey.

At initial activation, the video trigger level is set to 50%. The trigger level is displayed as a horizontal line across the entire measurement diagram. R&S FSP displays the 1 kHz AF signal as a static image in the time domain.

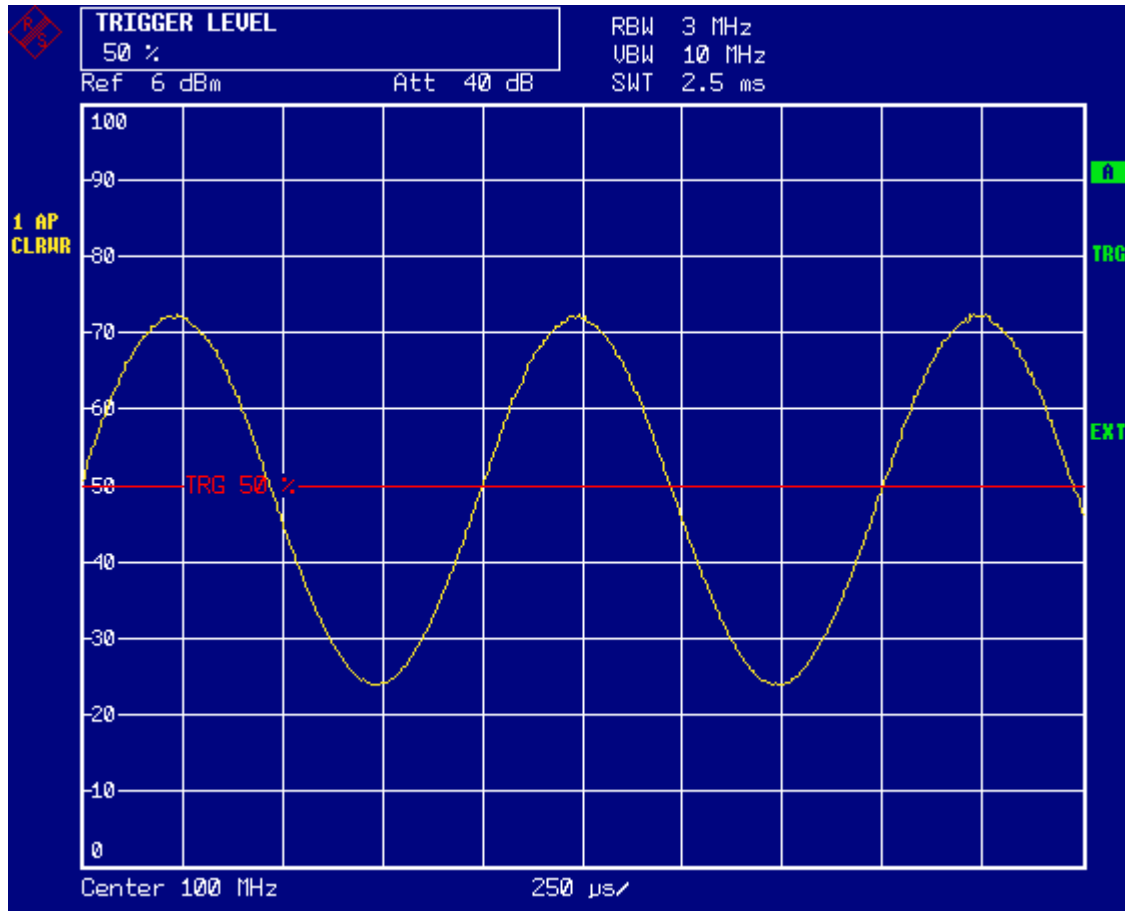

Fig. 5-13 Measurement of the AF signal of a carrier that is AM-modulated with 1 kHz
 If the option AM/FM demodulator (R&S FSP-B3) is implemented in the R&S FSP, the AF can be listened to by using the built-in loudspeaker:

5. Activate the internal AM demodulator.

- Press the *MKR FCTN* key.
- Press the *MKR DEMOD* softkey.
The R&S FSP automatically switches on the AM audio demodulator.
- Turn up the loudspeaker volume.
A 1 kHz tone can be heard from the internal loudspeaker.

5.4.5 Measurement of FM-Modulated Signals

Since analyzers can display only the magnitude of the measurement signal by using the envelope detector, the modulation of FM-modulated signals cannot be measured directly as in the case of AM-modulated signals. The voltage at the output of the envelope detector remains constant for FM-modulated signals as long as the frequency deviation of the signal is located within the flat part of the passband characteristic of the resolution filter that is used. Amplitude variation occurs only if the instantaneous frequency extends into a falling edge of the filter curve. This behavior can be used to demodulate FM-modulated signals. The center frequency of the R&S FSP is set in such a manner that the nominal frequency of the measurement signal is located on a filter edge (below or above the center frequency). The resolution bandwidth and the frequency offset must be selected in such a manner that the instantaneous frequency is located in the linear part of the filter edge. As a result, the frequency variation of the FM-modulated signal is transformed into an amplitude variation that can be displayed on screen in the time domain.

In the case of the four-circuit filters from 300 kHz to 3 MHz implemented as analog filters, you can obtain good linearity of the filter edge if the frequency of the R&S FSP is set to 1.2 times the filter bandwidth below or above the frequency of the transmit signal. The useful range for FM demodulation is then approx. equal to the resolution bandwidth.

5.4.5.1 Example - Display of the AF of an FM-Modulated Carrier

Test setup:

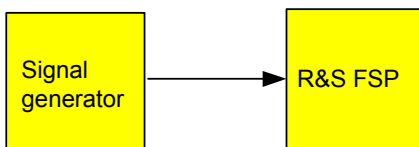

Settings on the signal generator (e.g. R&S SMIQ):

Frequency: 100 MHz
 Level: -30 dBm
 Modulation: FM 0 kHz deviation (i.e. FM modulation is deactivated), 1 kHz AF

Measurement with the R&S FSP:

1. Reset the instrument.

- Press the *PRESET* key.
The R&S FSP is now in the default state.

2. Set the center frequency to 99.64 MHz and the span to 300 kHz.

- Press the *FREQ* key and enter 99.64 MHz.
- Press the *SPAN* key and enter 300 kHz.

Measurements in the Time Domain

3. Set the resolution bandwidth to 300 kHz.

- Press the *BW* key.
- Press the *RES BW MANUAL* softkey and enter 300 kHz.

4. Set the display range to 20 dB and shift the filter trace to the center of the screen.

- Press the *AMPT* key.
- Press the *RANGE LOG MANUAL* softkey and enter 20 dB.
- Press the *NEXT* key.
- Set the *GRID* softkey to *REL*.
- Press the *PREV* key.
- Using the rotary knob, set the reference level such that the filter edge at the center frequency intersects the -10 dB level line.
The filter edge of the 300 kHz filter will appear on screen. This corresponds to the demodulator characteristic for FM signals with a steepness of approx. 5 dB/100 kHz.

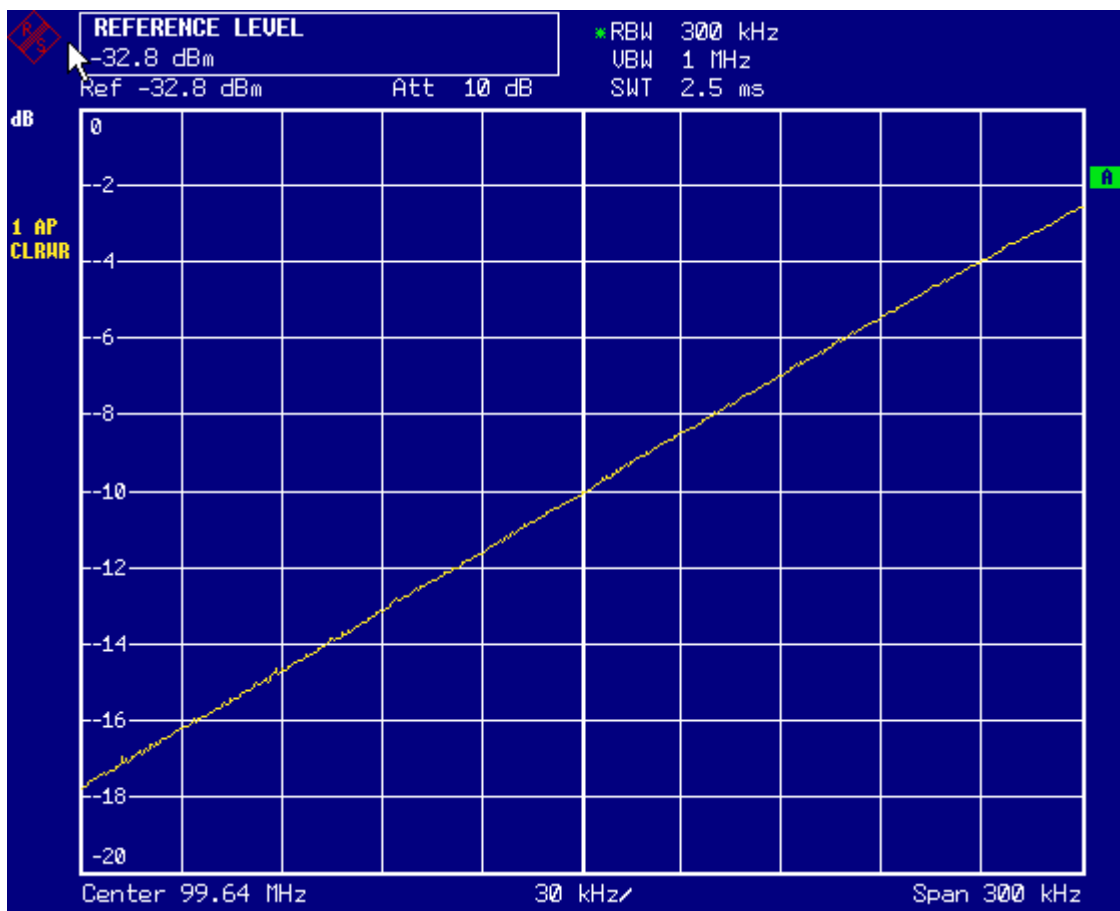

Fig. 5-14 Display of the filter edge of the 300 kHz filter as an FM discriminator characteristic.

Measurements in the Time Domain

5. Set the FM deviation to 100 kHz and the AF to 1 kHz on the signal generator.

6. Set the frequency deviation to 0 Hz on the R&S FSP.

➤ Press the SPAN key.

➤ Press the ZERO SPAN softkey.

The demodulated FM signal will appear on screen. The signal is continuous across the screen.

7. Establish a stable display by using video triggering.

➤ Press the TRIG key.

➤ Press the VIDEO softkey.

A static image for the FM AF signal is produced.

Result: (-10 ± 5) dB; this yields a deviation of 100 kHz when the steepness of the demodulator characteristic is 5 dB/100 kHz.

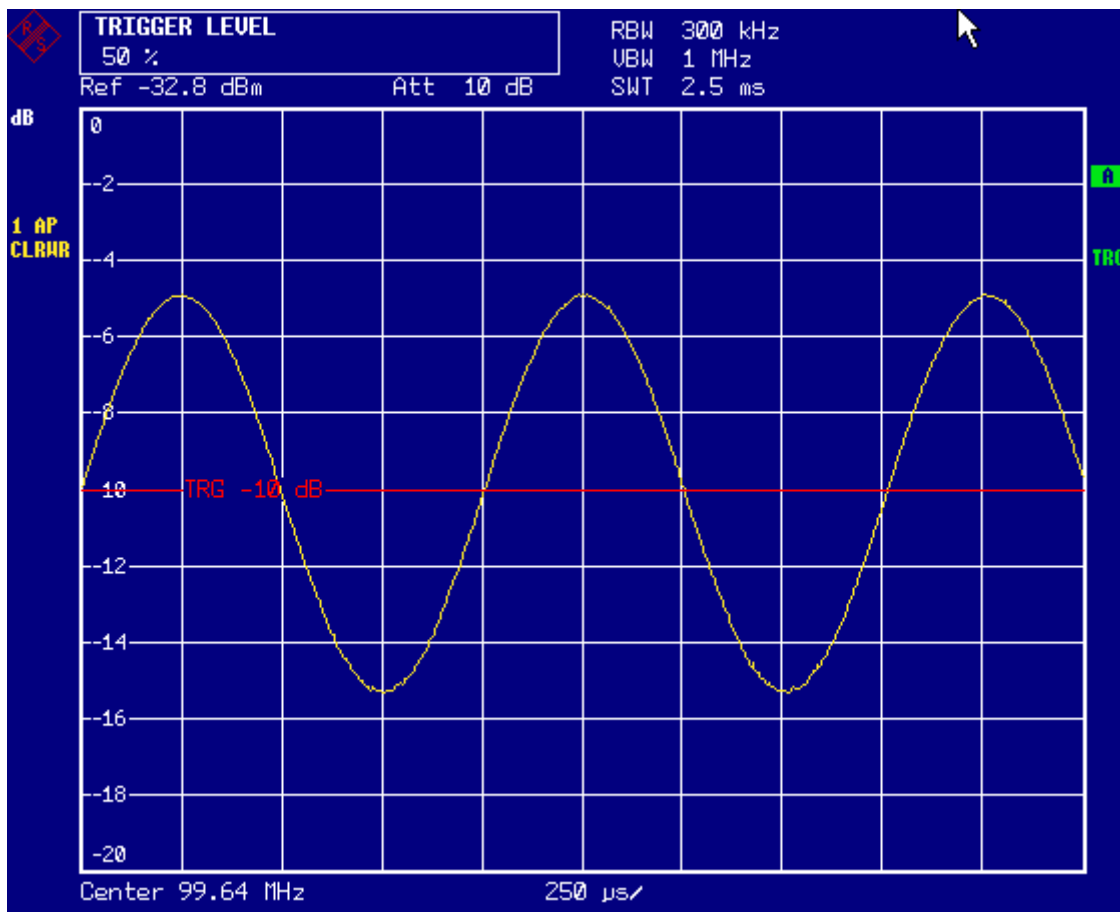

Fig. 5-15 Display of the demodulated FM signal

Storing and Loading Instrument Settings

5.5 Storing and Loading Instrument Settings

The R&S FSP can store complete instrument settings together with instrument configurations and measurement data internally as a data record. The data is stored on the built-in hard disk or – if selected – on a disk, a network drive, or a removable drive (e.g. a memory stick). The hard disk and the disk drive have the following drive names:

- Disk drive A:
- Hard disk D: (drive C: is reserved for the operating system)

The preset state (= *Current Settings*) includes that the settings of the measurement functions, *activated* limit lines and the *active* transducer factor are stored.

Use the *ITEMS TO SAVE/RCL* function to store/load traces and to store additional limit lines and transducer factors.

5.5.1 Storing an Instrument Configuration (without Traces)

You can store an instrument configuration as follows:

- Press the *FILE* key and then the *SAVE* softkey.

The selection dialog box for instrument configurations will open:

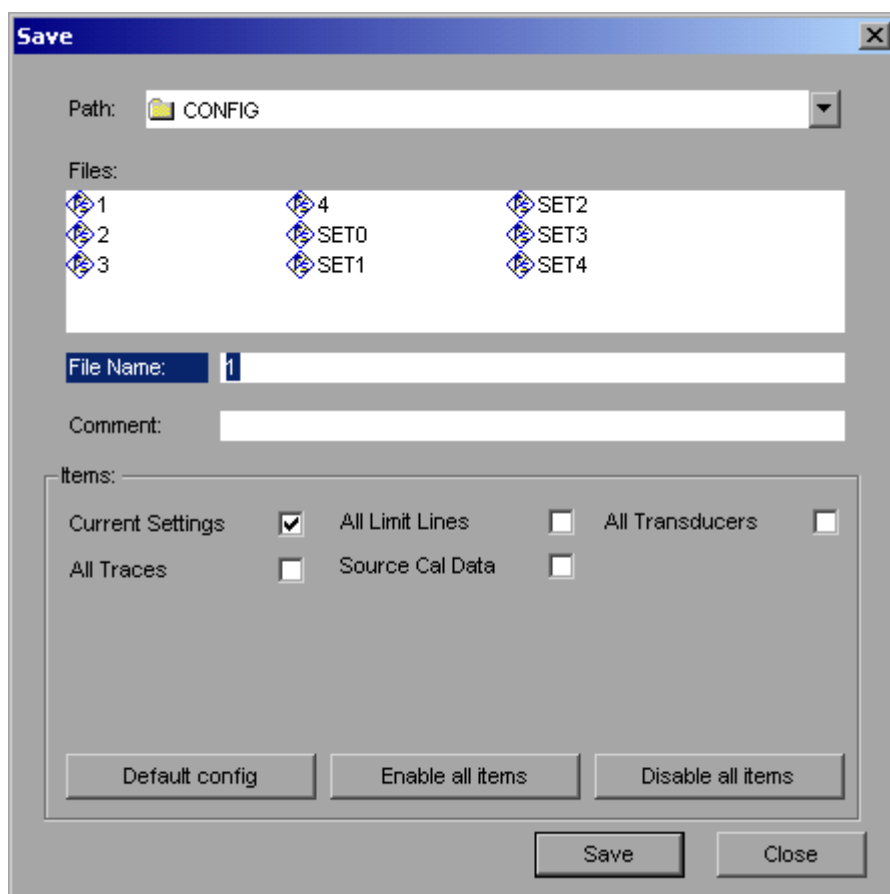

- Enter the name of the data record to be stored (which is a digit from 0 to 9 in the simplest case) and press *ENTER*. The data record will be stored and the dialog box will close.

Storing and Loading Instrument Settings



The name of a data record may contain letters and digits. If necessary, the desired directory can be placed in front of the name of the data record (the directory will then automatically be used for any further save and recall operations).

You can enter file names via the front panel keypad by using the alphanumeric editor, which can be called by pressing the arrow key . The operation of the editor is described in the section “[Editing Alphanumeric Parameters](#)” on page 4.9.

The default path for the instrument configurations is *D:\USER\CONFIG*. The file names of the data records end with “.FSP”.

5.5.1.1 Storing Traces

Before you can store traces, you must first select the associated partial data record. For this purpose proceed as follows:

- Press the *FILE* key and then the *SAVE* softkey.
- Press the *ITEMS TO SAVE/RCL* softkey. The entry cursor jumps to the first entry in the *Items* field.
- Using the rotary knob, move the cursor to *All Traces* in the *Items* field and then select the partial data record by pressing the rotary knob or *ENTER*.



You can cancel the selection by pressing the rotary knob or the *ENTER* key again.

You can select additional instrument settings to be stored by marking additional fields.

In addition, the *ENABLE ALL ITEMS / DISABLE ALL ITEMS* softkeys are available for selecting all partial data records or for cancelling the selection.

- Using the rotary knob, move the cursor to the *File Name* field and activate text entry by pressing the rotary knob.
- Enter a file name (or digit from 0 to 9) and store the data record by pressing *ENTER*.

5.5.2 Loading an Instrument Configuration

An instrument configuration can be loaded in either of the following two ways:

1. *By directly entering the data record name:*

- Press the *FILE* key and then the *RECALL* softkey.
- Enter the name of the data record to be loaded (which is a digit from 0 to 9 in the simplest case) and press *ENTER*. The data record will be loaded.

Storing and Loading Instrument Settings

2. By selecting the data record from a list:

- Press the *FILE* key and then the *RECALL* softkey.
- Press the *ITEMS TO SAVE/RCL* softkey.
The list of available data records is shown.

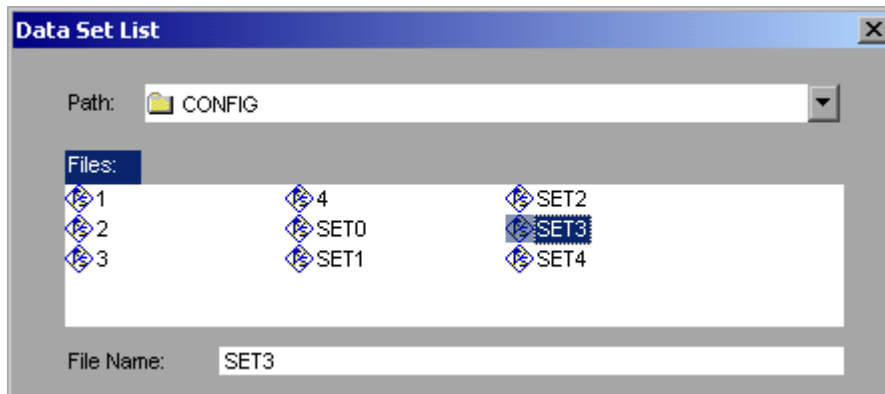

- Select the data record to be loaded by using the rotary knob and confirm by pressing *ENTER* twice. The data record will be loaded.
- To change the instrument configuration path, use the *EDIT PATH* softkey.



To load stored traces, use the *ITEMS TO SAVE/RCL* softkey to select the *All Traces* field. During loading, the R&S FSP detects which parts the called data record contains and, if applicable, ignores any partial data records that were selected but are not available.

5.5.2.1 Automatic Loading of a Data Record during Booting

If the R&S FSP is switched on in the factory default state, it loads the instrument settings that it had when switched off (provided that it was switched off using the *STANDBY* switch on the front panel; see chapter “[Switching Off the R&S FSP](#)” on page 2.7).

However, the R&S FSP can also automatically load a data record defined by the user. This requires performing the following procedure:

- Press the *FILE* key and then the *RECALL* softkey.
- Press the *STARTUP RECALL* softkey.
The list of available data records is shown.

Printing Out the Measurement Results

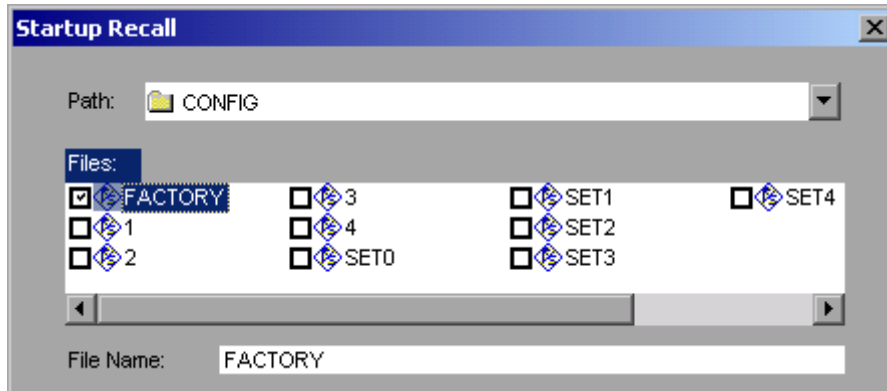

- Select the data record to be loaded by using the rotary knob and mark it with *ENTER*.
- Close the dialog box by pressing *ESC* twice.



- The selected data record will also be loaded by pressing the *PRESET* key.
- The *FACTORY* entry activates factory-default operation, i.e. the settings that were present at the time of deactivation will be loaded at activation.
- If you need to change the path for the instrument configuration, do so by using the *EDIT PATH* softkey.

5.6 Printing Out the Measurement Results

- Press the *HCOPY* key.
The menu for starting and configuring the printout will appear.
- Start the print operation by pressing the *PRINT SCREEN*, *PRINT TRACE* or *PRINT TABLE* softkey. The printout is based on the settings defined in the *DEVICE SETUP* dialog box and the *COLORS* submenu.



- If *PRINT SCREEN* is selected, all diagrams with traces and status displays will be printed out as they appear on screen. Softkeys, open tables and data entry fields will not appear on the printout.
- If *PRINT TRACE* is selected, only the displayed traces will be printed out. If *PRINT TABLE* is selected, only tables that appear on screen will be printed out.

- Select and configure the output interface by using the *DEVICE 1 / 2* softkey.
- You can redirect the printout to a file by selecting *PRINT TO FILE* from the *DEVICE SETUP* dialog box. Once you start the print operation by pressing one of the *print* softkeys, you will be prompted for the name of the file to which the output is to be redirected.
- The *COMMENT* softkey is available for labelling the printout (the date and time will automatically be added to the printout).

5.6.1 Selecting the Color Setting for the Printout

The *COLORS* submenu allows you to switch between black-and-white and color printouts (default). You can also select the color setting.

- *SCREEN*: Output using screen colors.
- *OPTIMIZED* (default): Instead of the bright colors for traces and markers, dark colors will be used: blue for trace 1, black for trace 2, green for trace 3, turquoise for markers.
- *USER DEFINED*: You can use this setting to customize the colors. The possible settings correspond to those in the *DISPLAY – CONFIG DISPLAY – NEXT* menu.



- In the case of the *SCREEN* and *OPTIMIZED* settings, the background is always printed out in white and the grid in black. In the case of the *USER DEFINED* setting, these colors can also be selected.
- When you open the submenu, the color display will be switched to the selected printout colors. When you exit the menu, the original color setting will be restored.

5.7 Additional Measurement Examples

The measurement examples provided in this section are intended as an introduction to operating the R&S FSP. For enhanced applications, refer to the Operating Manual, chapter 2, which provides a series of additional examples.

Measurement examples for the instrument's options are provided in the Operating Manuals for the individual options.

6 LAN Interface

6.1	Installing Additional Network Protocols & Services	6.3
6.2	Configuration Examples	6.6
6.3	Subsequent Changes to the Network Configuration	6.6
6.4	Configuring the Windows XP Firewall	6.8
6.5	Operating the Instrument without a Network	6.9
6.6	Operating the Instrument in a Network	6.9
6.6.1	Creating Users	6.9
6.6.2	Changing the User Password	6.11
6.6.3	NOVELL Network only: Configure NOVELL Client	6.13
6.6.4	Logging On to the Network	6.14
6.6.5	Deactivating the Automatic Login Mechanism	6.14
6.6.6	Reactivating the Automatic Login Mechanism	6.14
6.6.7	Using Network Drives	6.15
6.6.8	Installing a Network Printer	6.17
6.6.9	Sharing Directories (only with Microsoft Networks)	6.21
6.7	Manual Operation of the R&S FSP with XP Remote Desktop	6.24
6.7.1	Introduction	6.24
6.7.2	Configuring the R&S FSP for Use of XP Remote Desktop	6.24
6.7.3	Configuring the Controller	6.27

6.7.4 Connection Setup with the R&S FSP 6.30

6.7.5 Interrupting and Restoring the Remote Desktop
Connection with the R&S FSP 6.33

6.7.6 Deactivating the R&S FSP from the Controller 6.34



In some of the following step-by-step instructions, user names and passwords must be entered. This requires a mouse and an external keyboard is (the connection is described in sections “ [Connecting a Mouse](#)” and “ [Connecting an External Keyboard](#)” on page 2.9).

Installing Additional Network Protocols & Services

6.1 Installing Additional Network Protocols & Services



Your network administrator knows which protocols are necessary. In the case of the RSIB protocol and VX11 support, TCP/IP must always be installed. In the following example, the support for Novell Network will also be installed..

- Press the *SETUP* key.
The *SETUP* menu will open.
- Press the *GENERAL SETUP* softkey.
The *GENERAL SETUP* menu will open.
- Press the *CONFIGURE NETWORK* softkey.
The *Local Area Connection Status* dialog box will open.

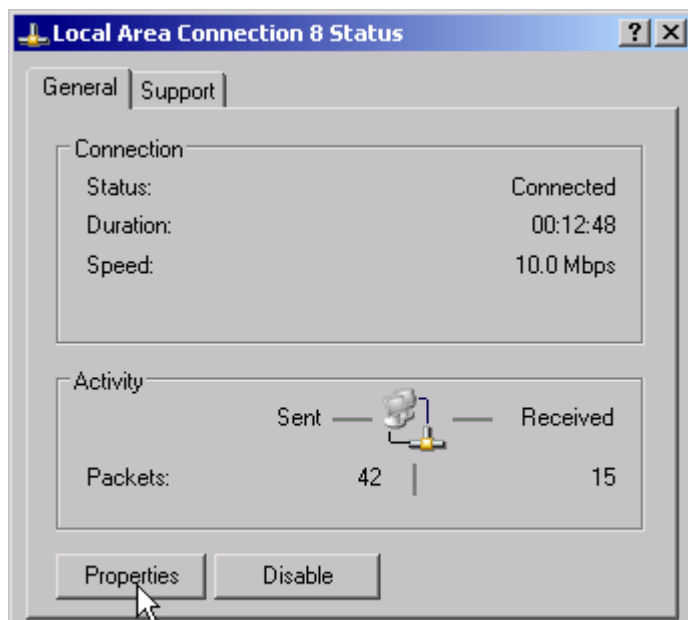

- Windows XP automatically appends numbers to the name Local Area Connection Status (e.g. Local Area Connection Status 8) if the configuration is created using the New Connection wizard. Since these numbers are unimportant in the following configuration steps, they are omitted in the description.
- Alternatively it is possible to access the dialog using a connected external keyboard. Proceed as follows:
Open the Windows XP Start menu with the Windows key or *CTRL+ESC*. Select *Settings - Network Connections - Local Area Connection*.
The Local Area Connection Status dialog box will open.

- Click the *Properties* button.
The dialog box containing the available network protocols will open.

Installing Additional Network Protocols & Services

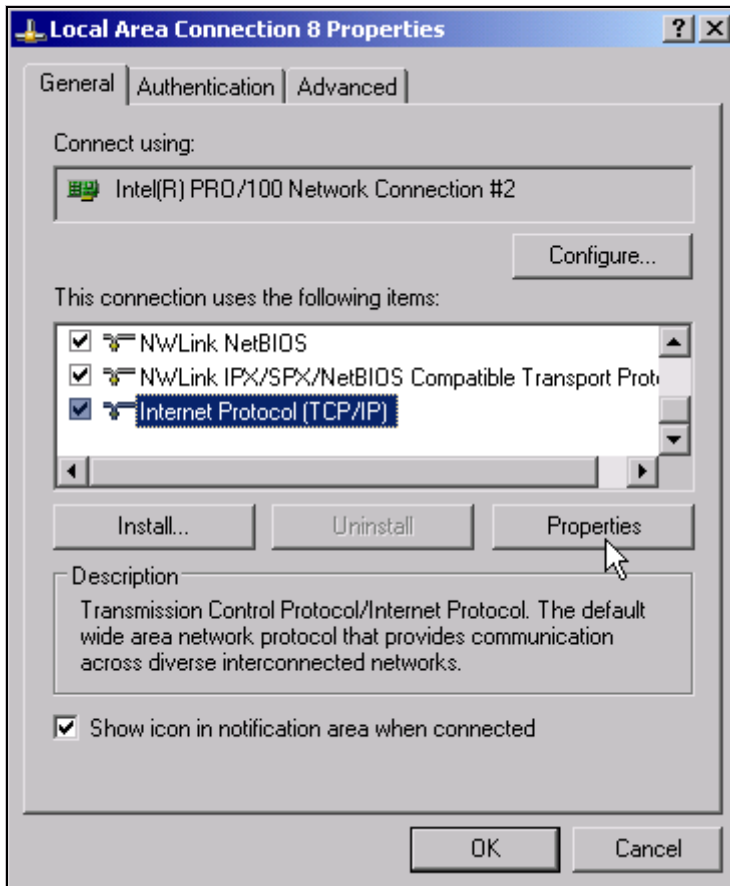

- Click the *Install* button.
The list of available network components will open.

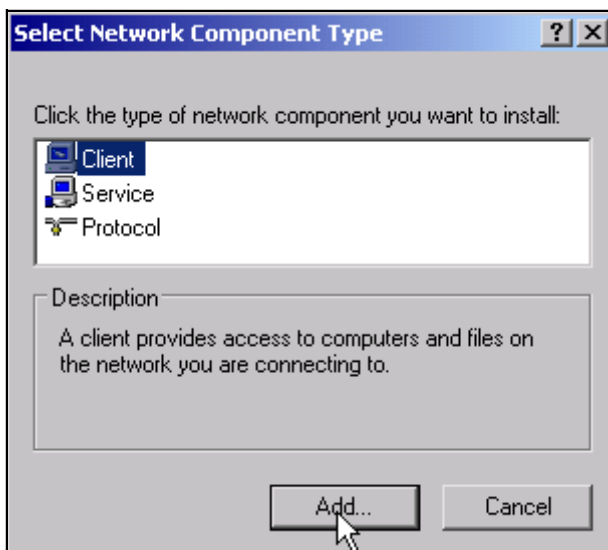

- Select *Client*.
- Click the *Add...* button.
The list of available network protocols will open.

Installing Additional Network Protocols & Services

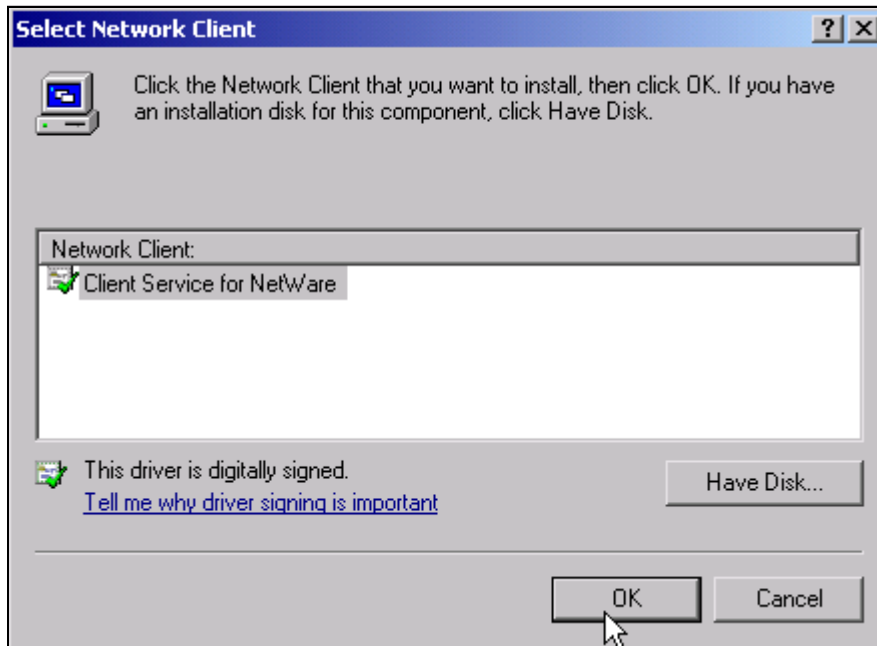

- Select *Client Service for NetWare*.
- Click the *OK* button.
The network driver for Novell Netware will be installed.



- Your network administrator knows which clients, services and protocols must be installed for your network.
- If network components are not included in *D:\I386* they have to be installed e.g. using a disk containing the drivers (or a CD that is replayed via a USB CD-ROM drive).
In this case, click the *Have Disk* button and specify the path with the corresponding drivers.

After you complete the installation, you will be prompted to restart the instrument.

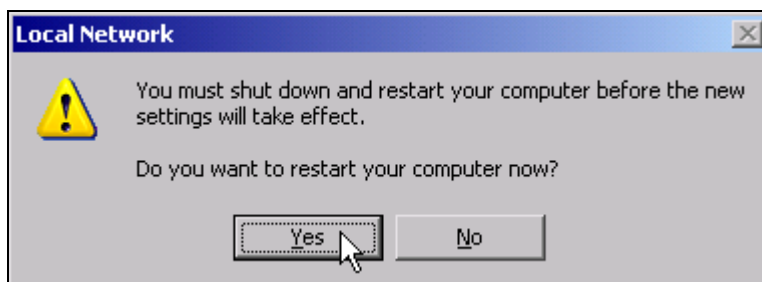

- Click the *Yes* button.
Windows will restart the system.

6.2 Configuration Examples

Network	Protocols	Services	Comments
NOVELL Netware	NWLink IPX/SPX compatible transport	Client service for NetWare	The frame type used in the network must be set under <i>Protocols - Properties</i> .
IP Networks (FTP, TELNET, WWW, GOPHER, etc.)	TCP/IP	Simple TCP/IP services	An IP address that is unique in the network must be set under <i>Protocols - Properties</i> .
MICROSOFT Network	TCP/IP	Workstation server	A name that is unique in the network must be set under <i>Identification - Computer Name</i> .

6.3 Subsequent Changes to the Network Configuration

This chapter describes changes to the network configuration like the computer name, the domain or the workgroup.

After completing the installation, you can modify the computer name as follows:

- Press the Windows key or *CTRL+ESC*.
The Windows Start menu will open.

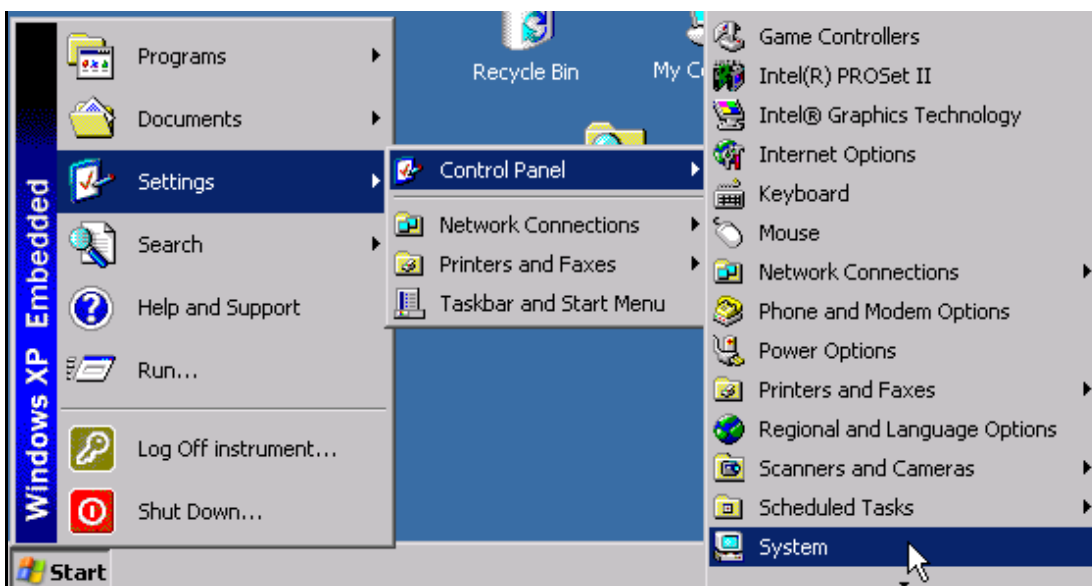

- Select Settings - Control Panel - System.
The *System Properties* dialog will open.

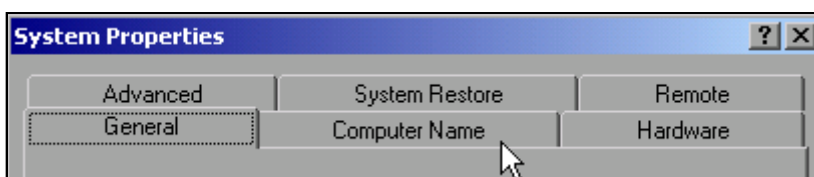

- Select the *Computer Name*.

Subsequent Changes to the Network Configuration



You can change the other settings after you select the other tabs. Before doing so, however, be sure to check with your network administrator.

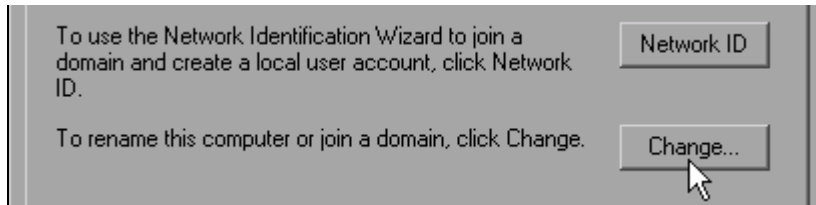

- Click the *Change* button.

The dialog box for changing the computer name, domain and workgroup will open.

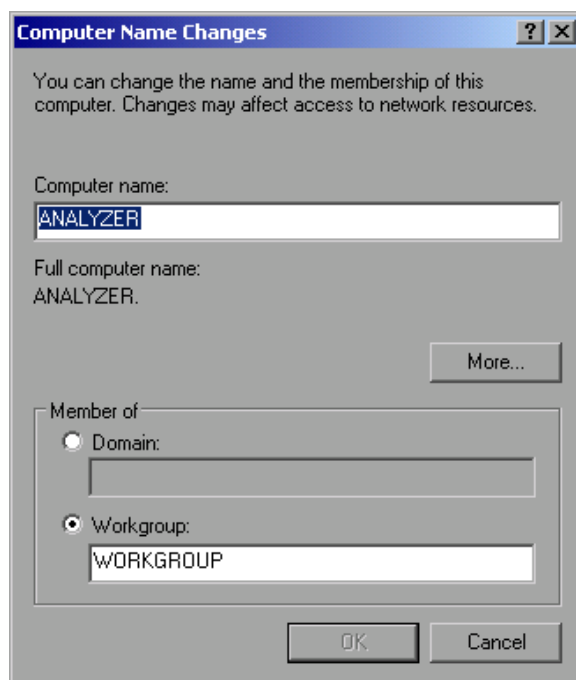

- Enter a new computer name.
- If necessary, enter a *Domain* or *Workgroup*.
- Confirm changes with *OK*.

You are prompted to restart the instrument:

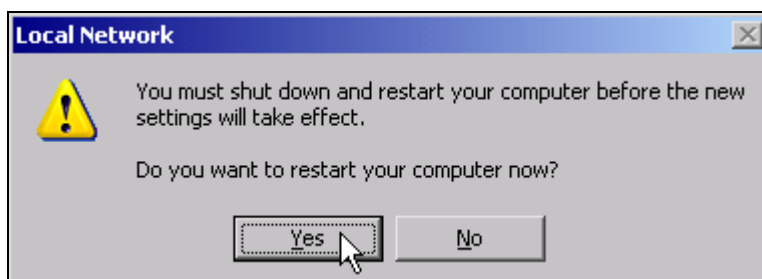

- Click the *Yes* button.
Windows will restart the system.

Configuring the Windows XP Firewall

6.4 Configuring the Windows XP Firewall

The Windows XP Firewall blocks all network communication which is not initialized by the controller itself or which is defined as unwanted. It protects the controller from an attack of hostile users and programs. On the instrument, the Internet Connection Firewall (ICF) is activated for all network connections by default to enhance protection of the instrument.

The default configuration of the firewall enables data transfer with other controllers in a local network, file and printer sharing and remote control via LAN. To change these settings for security reasons, perform the following steps:

- Using the Windows key or the key combination *CTRL+ESC*, call the Windows XP Start menu.
- Click *Settings* and then *Control Panel* and *Windows Firewall*. The *Windows Firewall* dialog box is displayed.

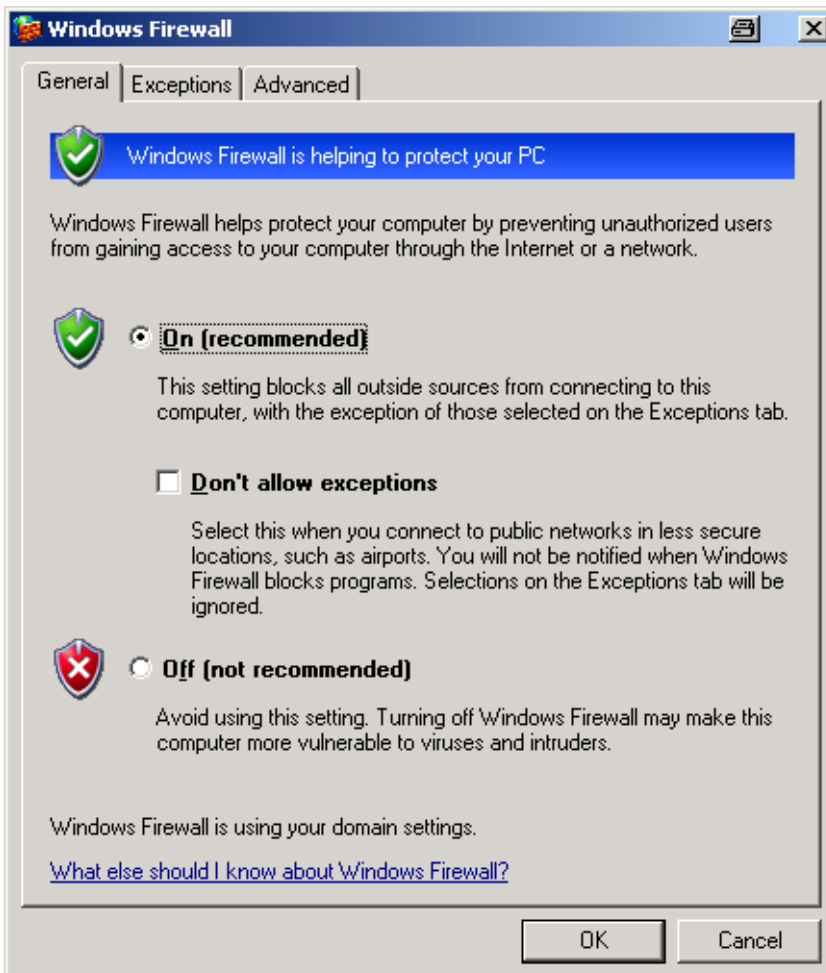

Operating the Instrument without a Network

6.5 Operating the Instrument without a Network

If you want to operate the instrument either temporarily or permanently without a network connection, no special measures are necessary in contrast to Windows NT. Windows XP automatically detects the interruption of the network connection and does not set up the connection when the instrument is switched on.

If you are not prompted to enter the user name and password, proceed as described in the section “[Reactivating the Automatic Login Mechanism](#)” on page 6.14.

6.6 Operating the Instrument in a Network

After network support has been installed, data can be exchanged between the instrument and other computers, and network printers can be used.

Network operation is possible only if you are authorized to use network resources. Typical resources are file directories of other computers or even central printers.

Authorization is assigned by the network or server administrator. This requires having the network names of the resources and the corresponding authorizations.

6.6.1 Creating Users

After the software for the network has been installed, the instrument will issue an error message the next time it is switched on, because there is no user named *instrument* (= user ID for Windows XP automatic login) in the network. Thus, a matching user must be created in Windows XP and in the network, the password must be adapted to the network password, and the automatic login mechanism must then be deactivated.

The network administrator is responsible for creating new users in the network. A new user can be created on the instrument by using the User Account wizard:

- Using the Windows key or the key combination *CTRL+ESC*, call the Windows XP Start menu.

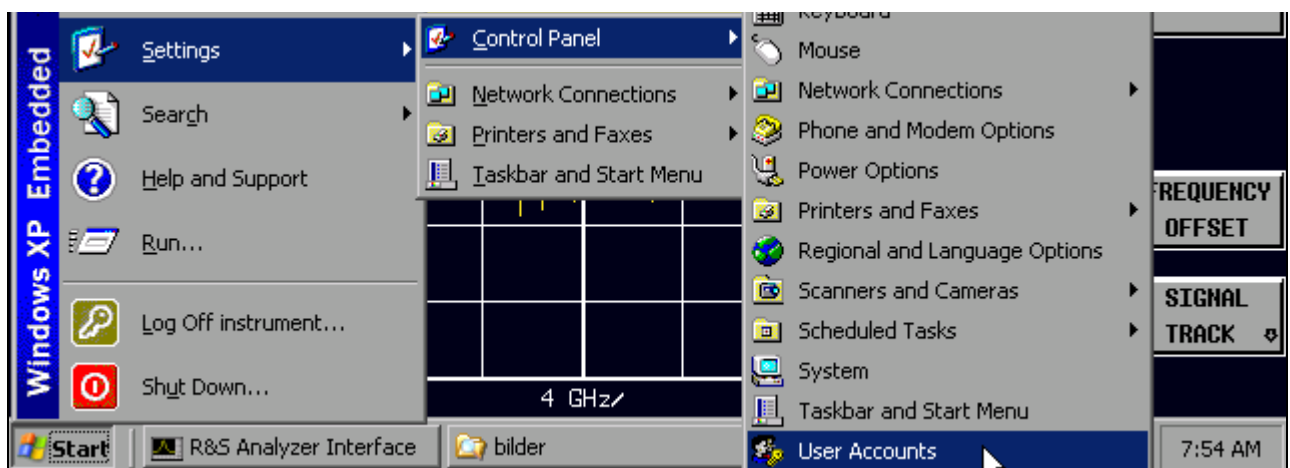

- Click *Settings* and then *Control Panel* and *User Accounts*.
The wizard for managing the user will open with the *Pick a task...* dialog box.

Operating the Instrument in a Network

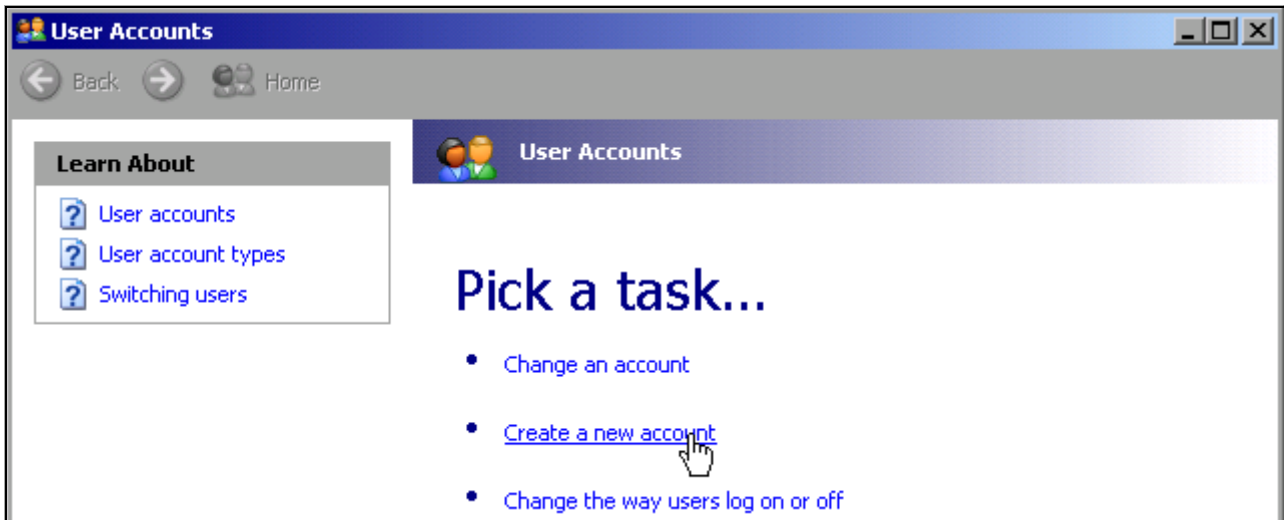

- Select *Create a new account*.
The dialog box for entering a new computer name will open.

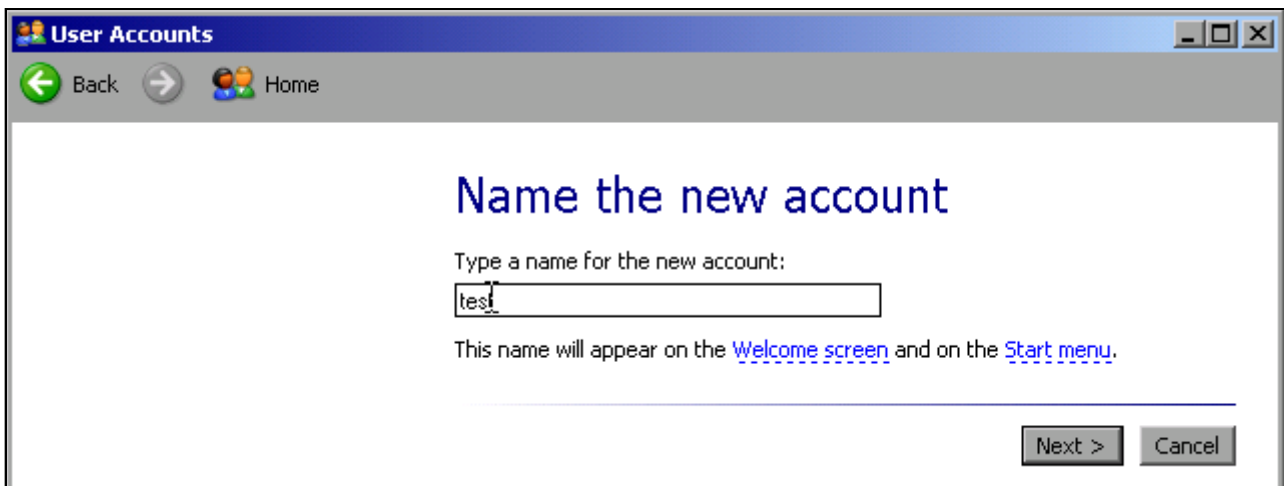

- Enter the name of the new user in the text field and confirm with *Next ->*. The *Pick an account type* dialog box for defining the user's rights will open.



- Select *Computer administrator*.



Proper firmware function requires administrator rights.

Operating the Instrument in a Network



- Conclude the creation of the new user by clicking the *Create Account* button. The new user has now been created.

6.6.2 Changing the User Password

After the new user has been created on the instrument, the password must be adapted to the network password. This is also done by using the User Account wizard.

- Using the Windows key or the key combination *CTRL+ESC*, call the Windows XP Start menu.
- Click *Settings* and then *Control Panel* and *User Accounts*. The wizard for managing the users will open with the *Pick a task...* dialog box.

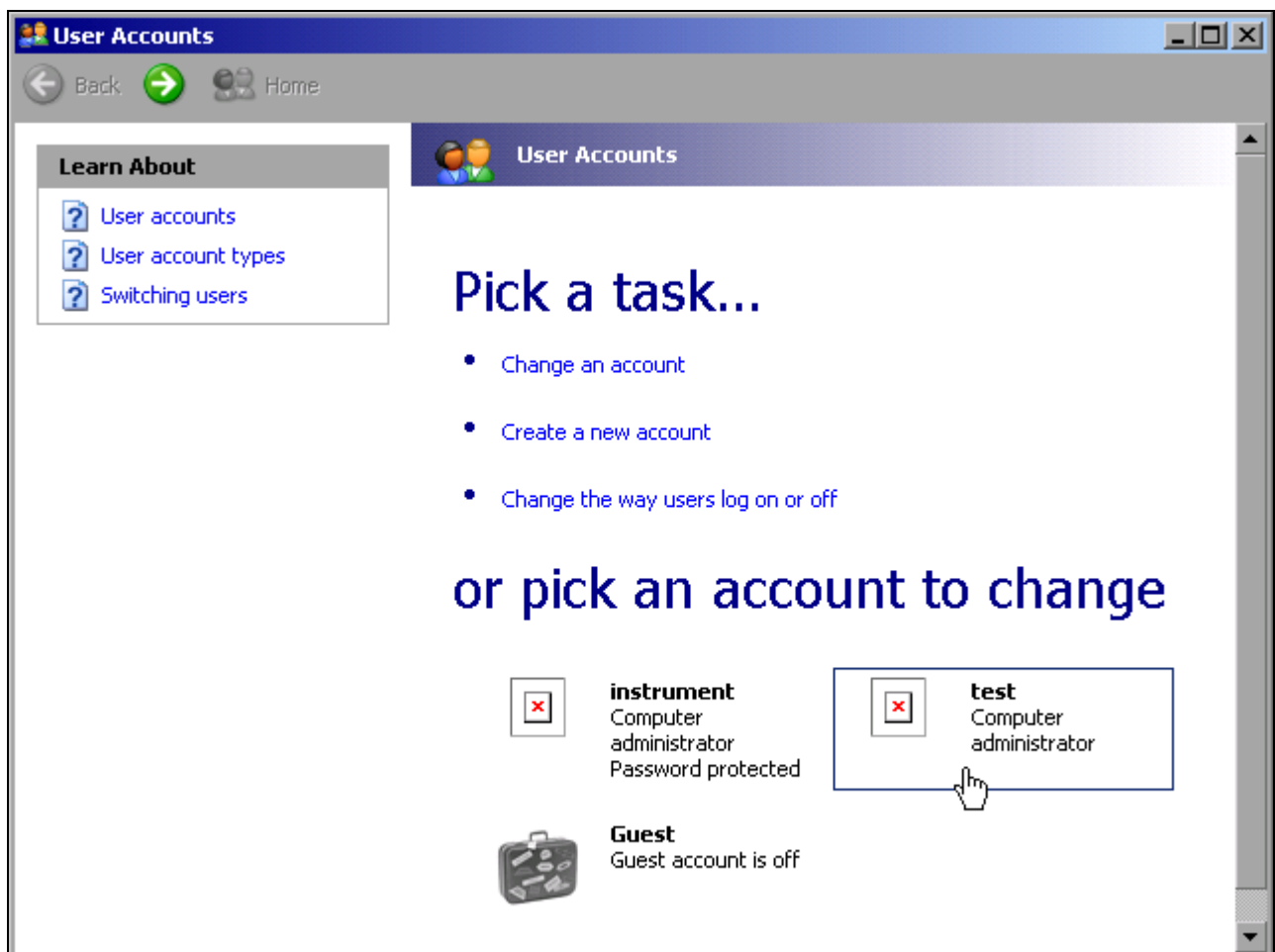

- Click the desired user account (in the example: user *Test*). The dialog box for selecting the desired action will open.

Operating the Instrument in a Network

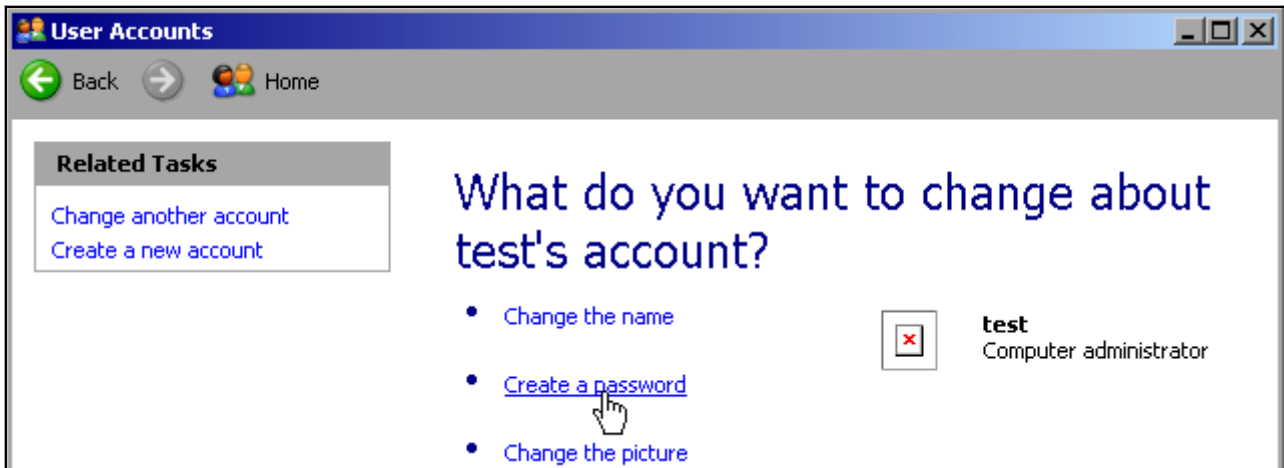

- Click *Create a password*.
The dialog box for entering a new password will open.

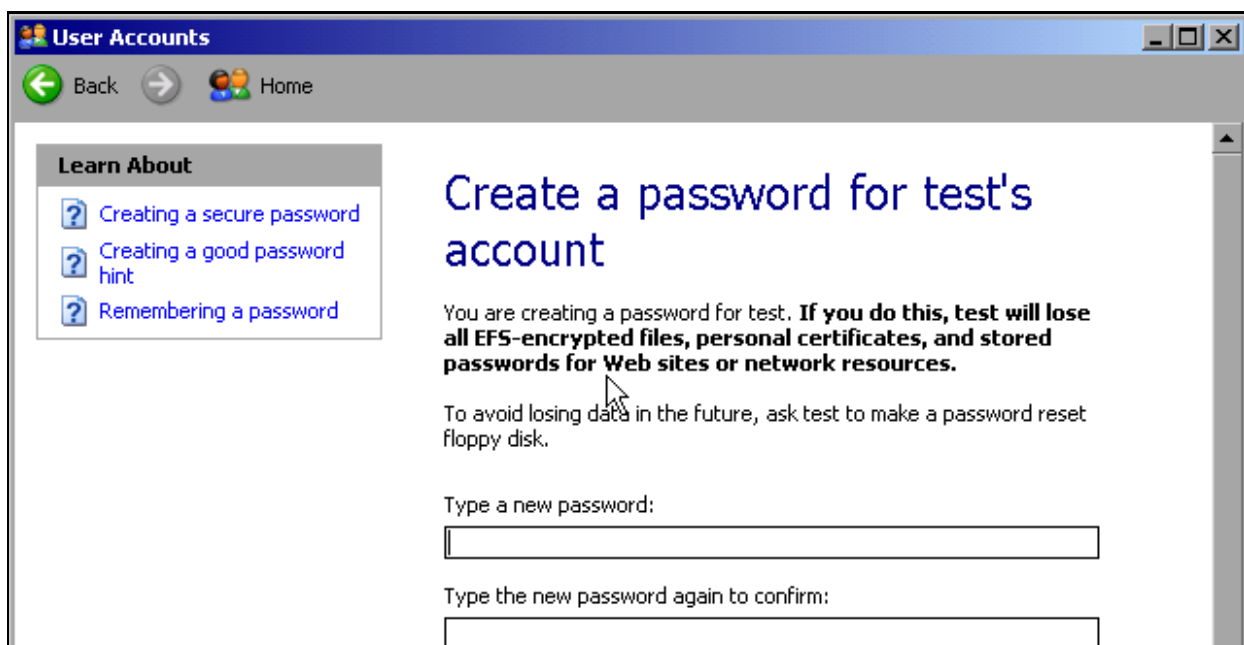

- Enter the new password in the upper text line and repeat it in the following line.
- Scroll the screen contents down.



- Conclude the entry with the *Create Password* button.
The new password is now active.

Operating the Instrument in a Network

6.6.3 NOVELL Network only: Configure NOVELL Client

- Using the Windows key or the key combination *CTRL+ESC*, call the Windows XP Start menu.

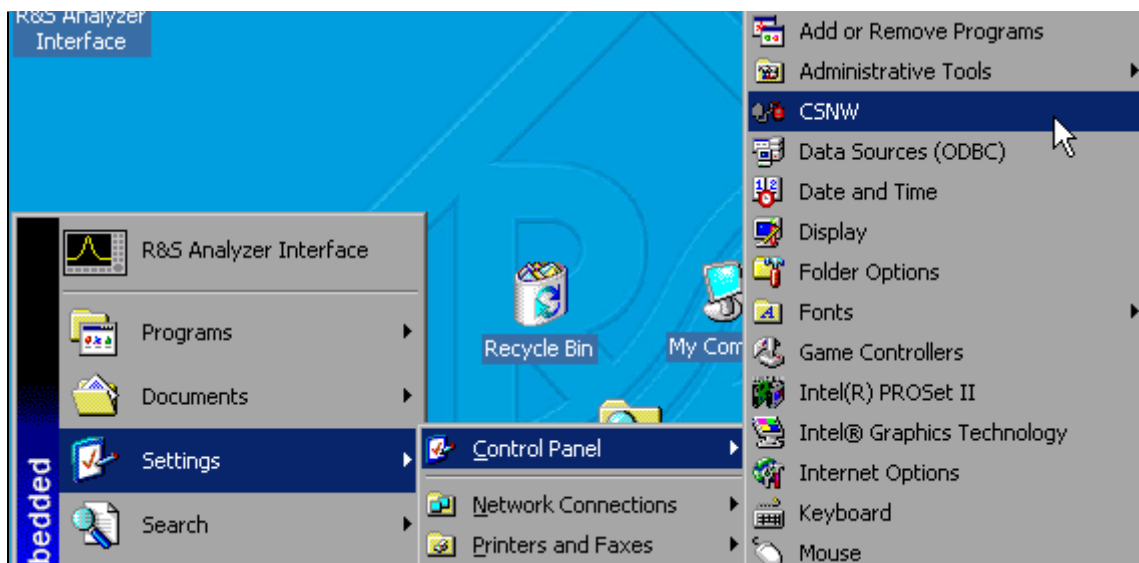

- Click *Settings* and then *Control Panel* and *CSNW*.

Bindary Login (NOVELL 3.x)

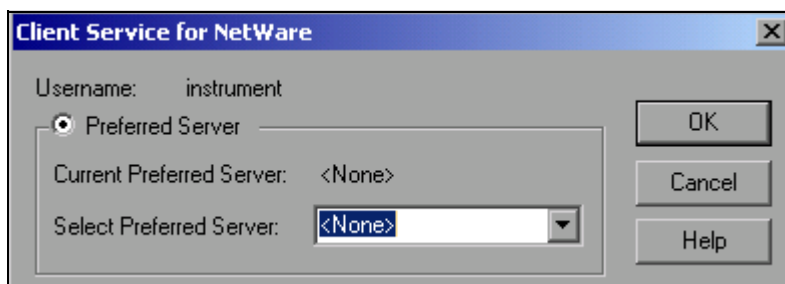

- Click *Default Tree and Context*.
- Under *Select Preferred Server*, select the NOVELL server on which the user has been created.

NDS Login (newer NOVELL versions)

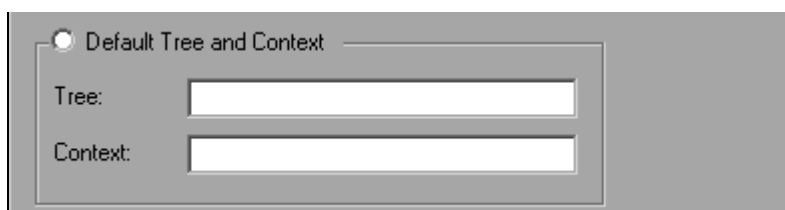

- Click *Default Tree and Context*.
- Under *Tree*, enter the NDS Tree and, under *Context*, the hierarchical path on which the user has been created.

Operating the Instrument in a Network

- If desired, click the *Run Login Script* entry.



You can obtain this information from your network administrator.

- Conclude the login configuration with *OK*.

6.6.4 Logging On to the Network

Network login occurs at the same time you log on to the operating system. For this to be possible, the user name and the password must be identical under Windows XP and on the network.

6.6.5 Deactivating the Automatic Login Mechanism

When shipped, the instrument is already configured to automatically log on under Windows XP. To deactivate the automatic login mechanism, perform the following steps:

- Open the Windows XP Start menu with *CTRL+ESC*.
- Select *RUN* from the menu.
An entry field will open.
- Enter the command *D:\USER\NOAUTOLOGIN.REG* in the entry field and confirm it with *ENTER*.

The automatic login mechanism will be deactivated. The next time you switch on the instrument, you will be prompted to enter your user name and password before the firmware is started.

6.6.6 Reactivating the Automatic Login Mechanism

To reactivate the automatic login mechanism, do the following:

- Open the Windows XP Start menu with *CTRL+ESC*.
- Select *RUN* from the menu. The entry field will open.
- Enter the command *D:\USER\AUTOLOGIN.REG* in the entry field and confirm it with *ENTER*.

The automatic login mechanism will be reactivated,. It will be applied the next time the instrument is switched on.

Operating the Instrument in a Network

6.6.7 Using Network Drives

- Using the Windows key or the key combination *CTRL+ESC*, call the Windows XP Start menu.
- Click *Programs*, and then *Accessories* and *Windows Explorer*.
- Under Desktop, click *My Network Places* and *Entire Network*
All available network drives will be displayed.

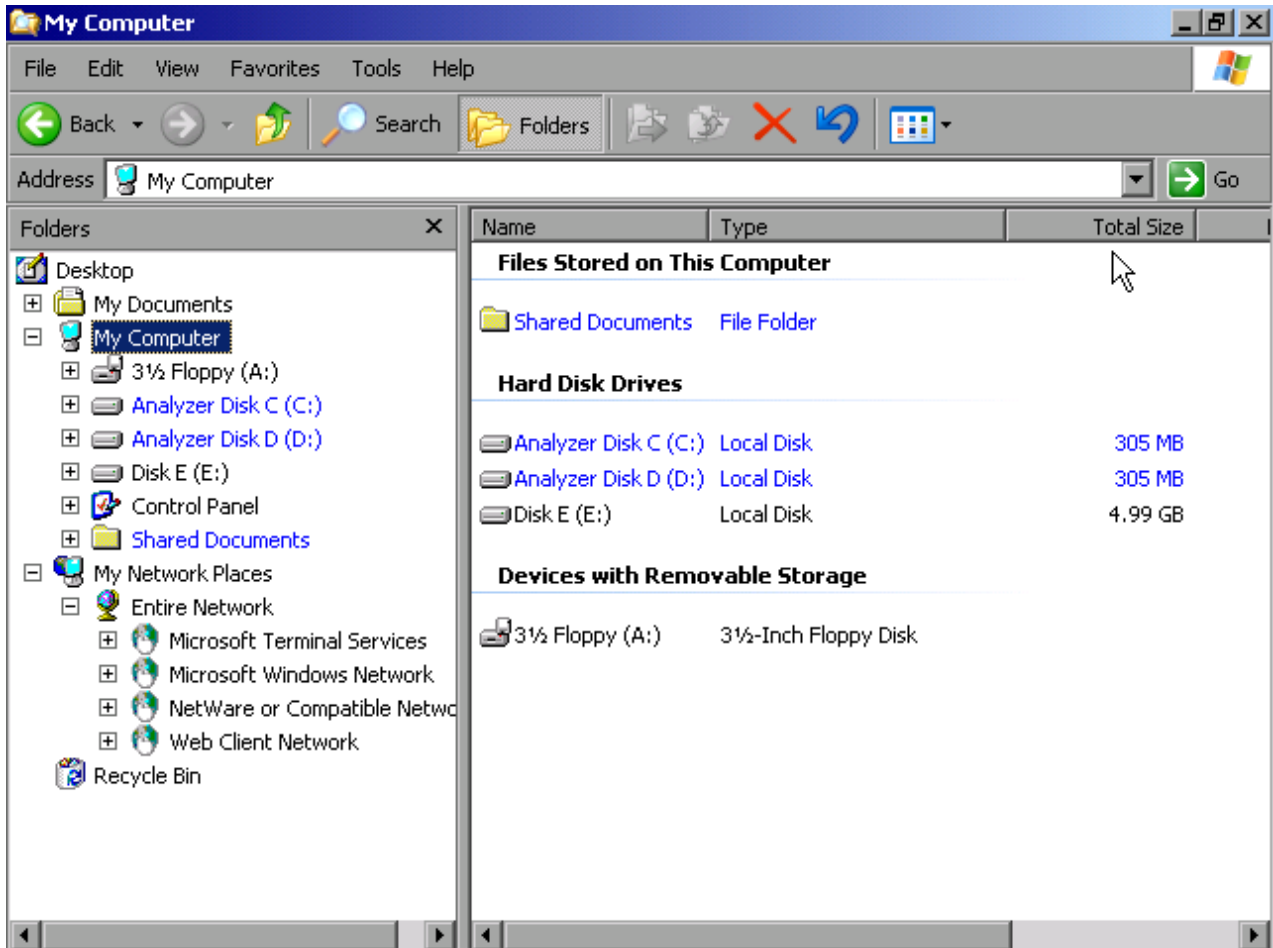

- Click *Tools* and then *Map Network Drive*.

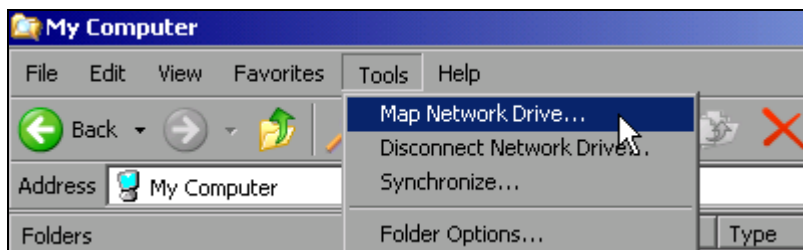

The *Map Network Drive* dialog will open:

Operating the Instrument in a Network

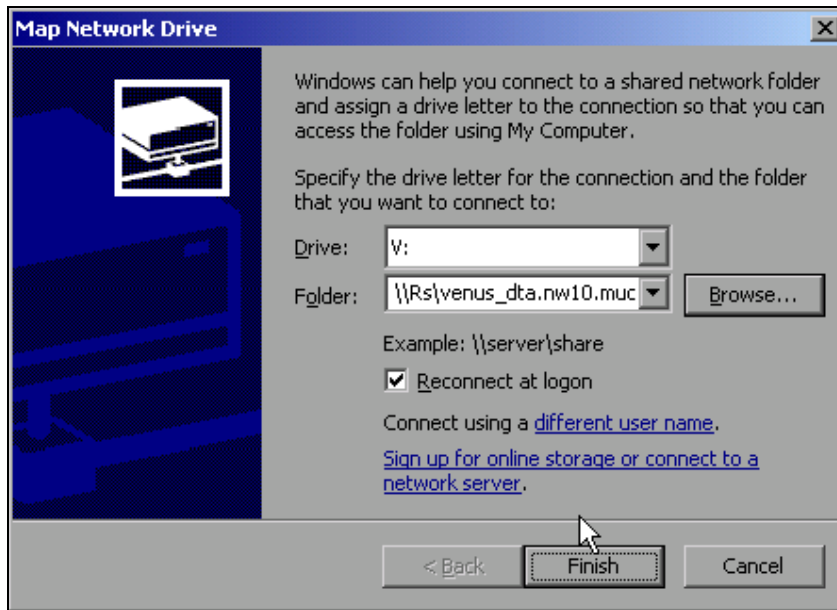

- Under *Drive*: click the drive.
- Using *Browse*, open the list of network paths available in the network.
- Mark the desired network path.
- Activate *Reconnect at Logon*: if you want the connection to be set up automatically each time the instrument is started.
- Click *Finish* to connect the network path with the selected drive.
You will be now prompted to enter your user name and password.

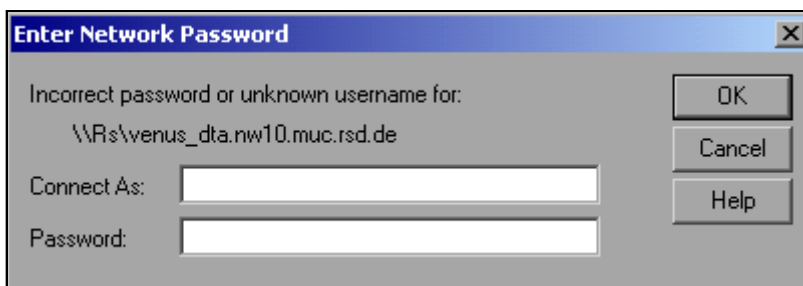

The drive will then appear under *All Directories* in Explorer.



Only networks authorized in the network will be connected.

Terminate the connection

- In Windows Explorer, click *Tools* and then *Disconnect Network Drive*.
- Under *Drive:*, select the drive whose connection is to be terminated.
- Click *OK* to terminate the connection. You will need to confirm this step with *Yes*.

Operating the Instrument in a Network

6.6.8 Installing a Network Printer

A new printer is installed using the *INSTALL PRINTER* softkey in the *HCOPY* menu.

- Click the *HCOPY* key.
The *HCOPY* menu will open.
- Click the *NEXT* key to go to the side menu.
- Using *INSTALL PRINTER*, open the *Printers and Faxes* dialog box

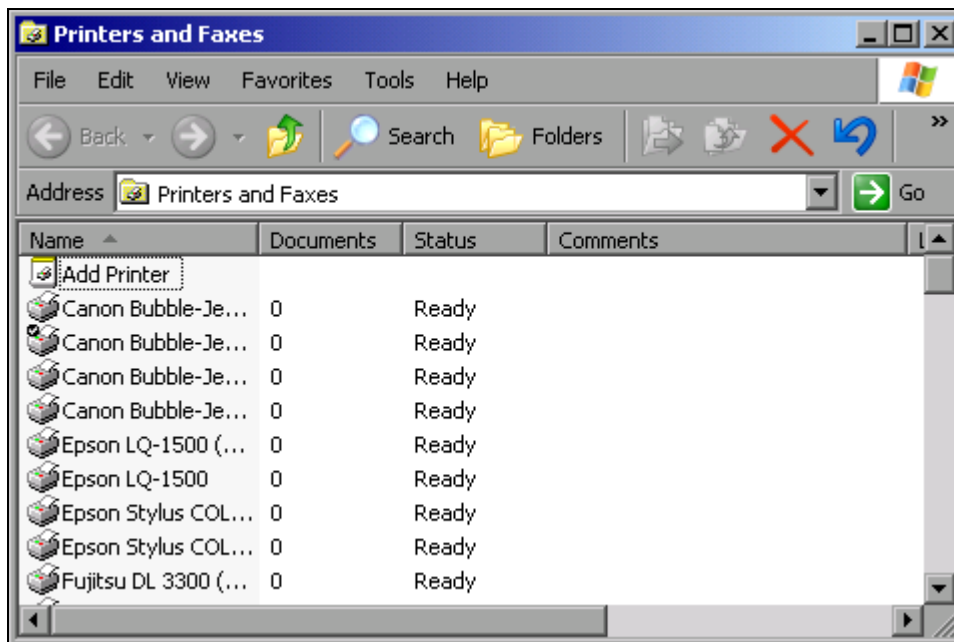

- Using the rotary knob, go to Add Printer in the selection list.
- Using right arrow key, mark the entry and then confirm by pressing *ENTER* or the rotary knob.
The *Add Printer Wizard* will now appear.

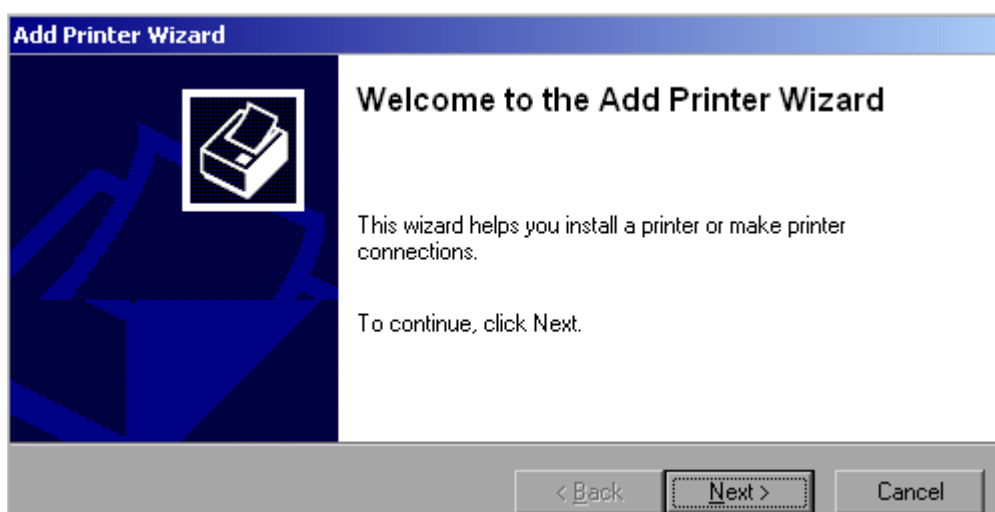

Operating the Instrument in a Network

- Select *Next* with the rotary knob and then press the rotary knob to confirm. The *Local or Network Printer* selection will appear.

In this example, an HP Laserjet 5 printer is installed as a network printer.

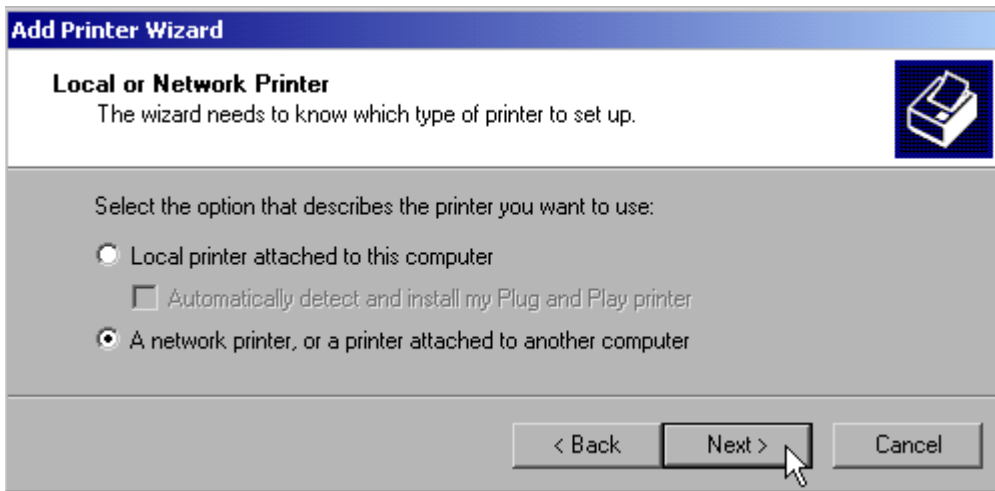

- To select a network printer, activate *A network printer or a printer attached to another computer*.
- Click *Next* to continue. The *Specify a Printer* dialog will open.

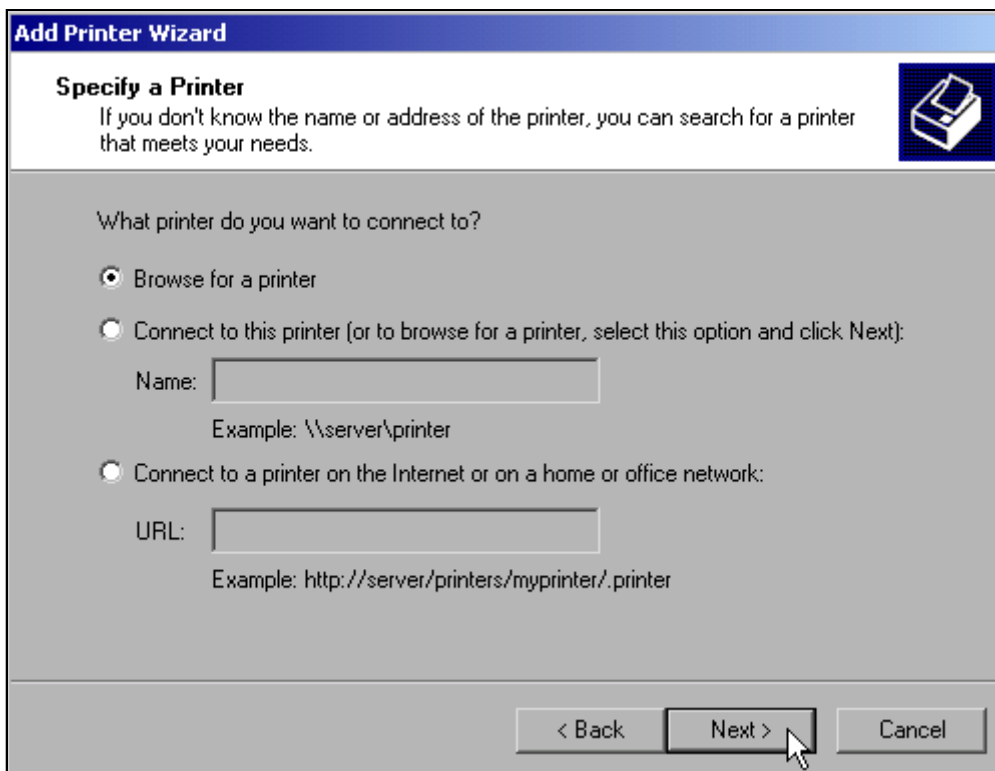

- Click *Browse for a printer* and then *Next*. The selection of enabled printers will appear.

Operating the Instrument in a Network

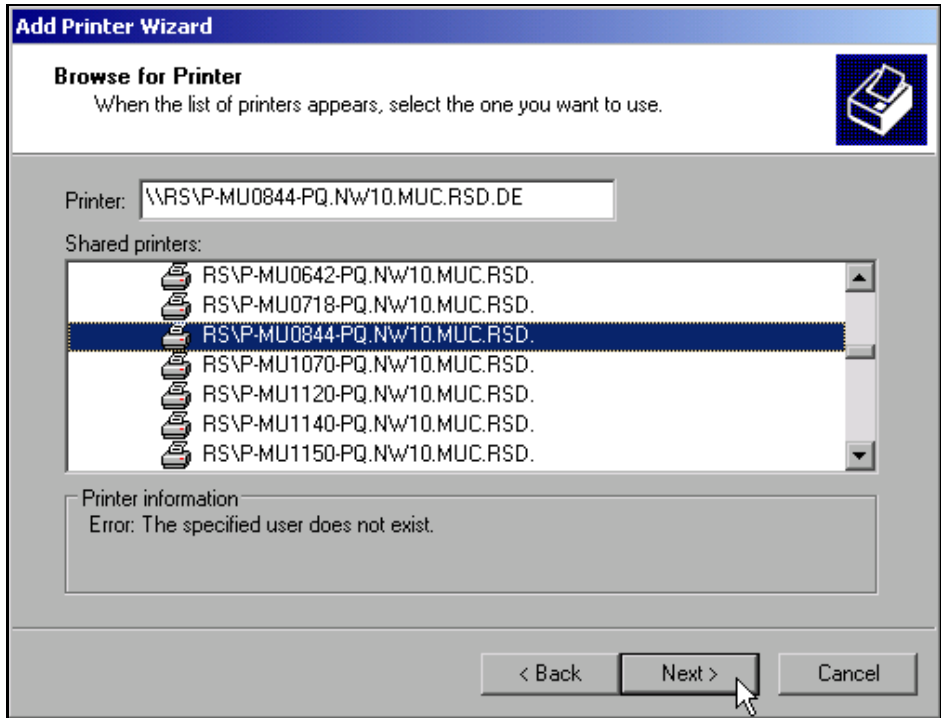

- Mark a printer and confirm with **OK**.
- When you are prompted to confirm the installation of a suitable printer driver, click **OK**. The selection of printer drivers will appear. The left-hand pane will list the manufacturers and the right-hand pane the available printer drivers.

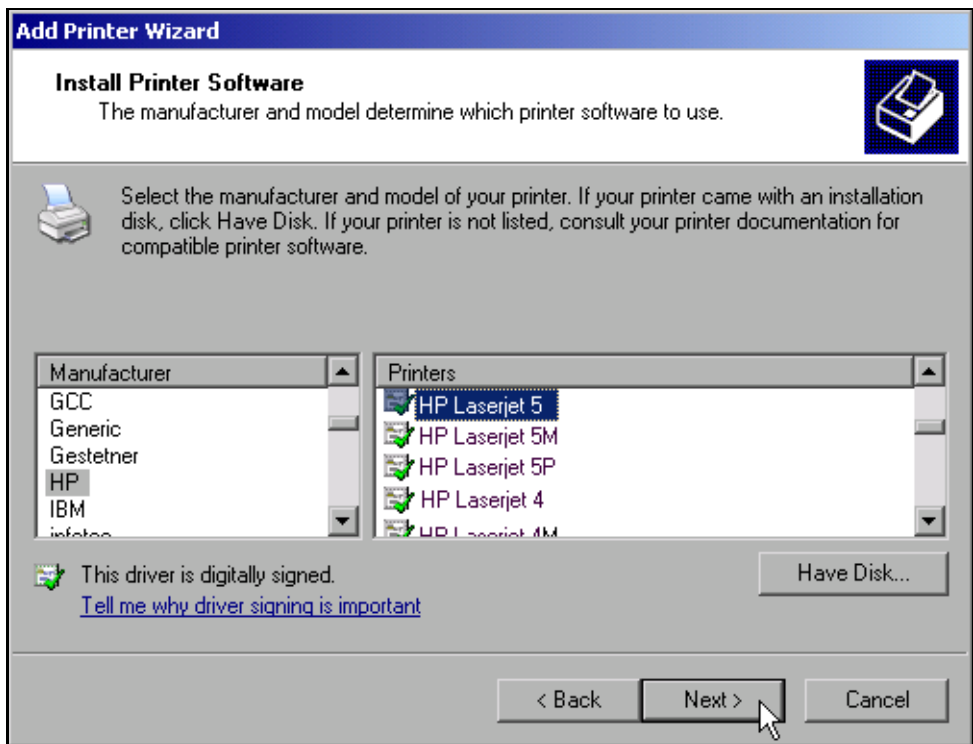

- Select the appropriate manufacturer under *Manufacturers* and then the appropriate printer driver under *Printers*.

Operating the Instrument in a Network



If the printer you need does not appear in the list, the driver has not yet been installed on the instrument. In this case, click the *Have Disk* button. You will then be prompted to insert a disk containing the required driver. Then press *OK* and select the printer driver.

- Click *Next*.

The default printer selection dialog is opened.

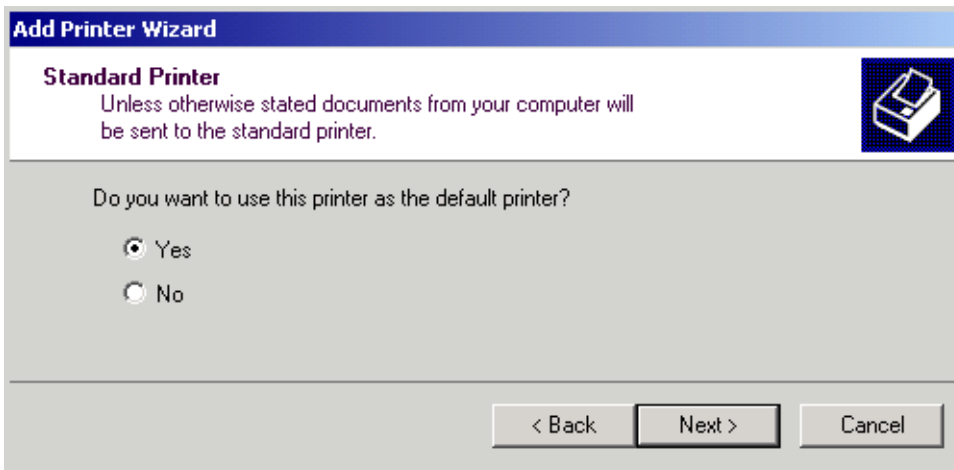

If one or more printers have already been installed, you will now be asked whether you want to use the printer you just installed as the default printer for Windows XP applications. The default response is *No*.

- After selecting the default printer, click *Next*. The final message of the installation wizard is displayed.

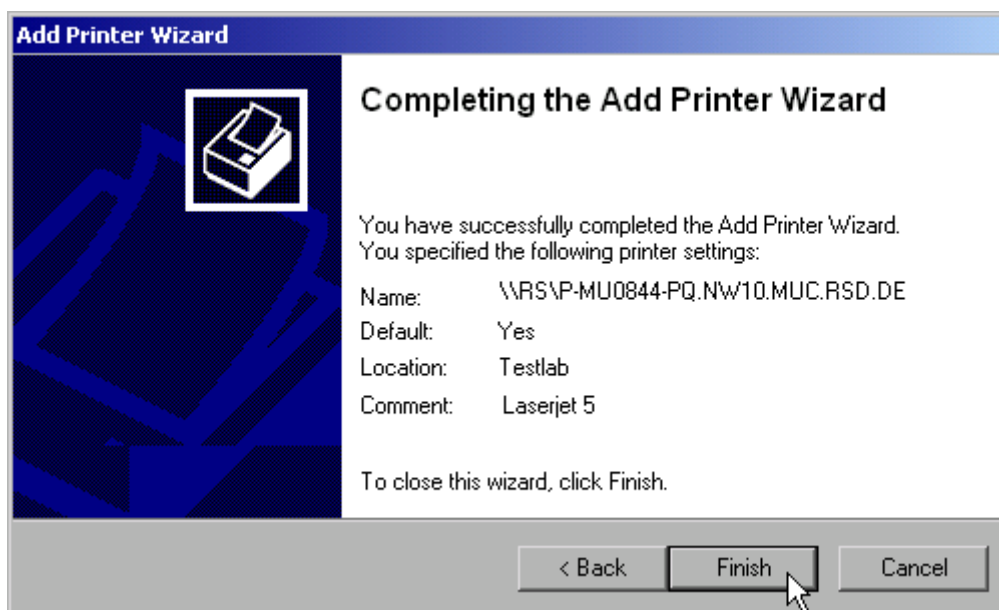

- Click the *Finish* button to start installation of the printer driver.

Operating the Instrument in a Network

- Configure the R&S FSP for printout with this printer using the *DEVICE SETUP* and *DEVICE 1/2* softkeys in the hardcopy main menu (see section “[Selecting and Configuring Printers](#)” on page 2.27).

6.6.9 Sharing Directories (only with Microsoft Networks)

Sharing directories makes data on the device available for use on other computers. This is possible only in Microsoft networks.

Sharing is a property of a file or directory. The procedure for applying sharing is as follows:

- Open the Windows Start menu with the Windows key or *CTRL+ESC*.

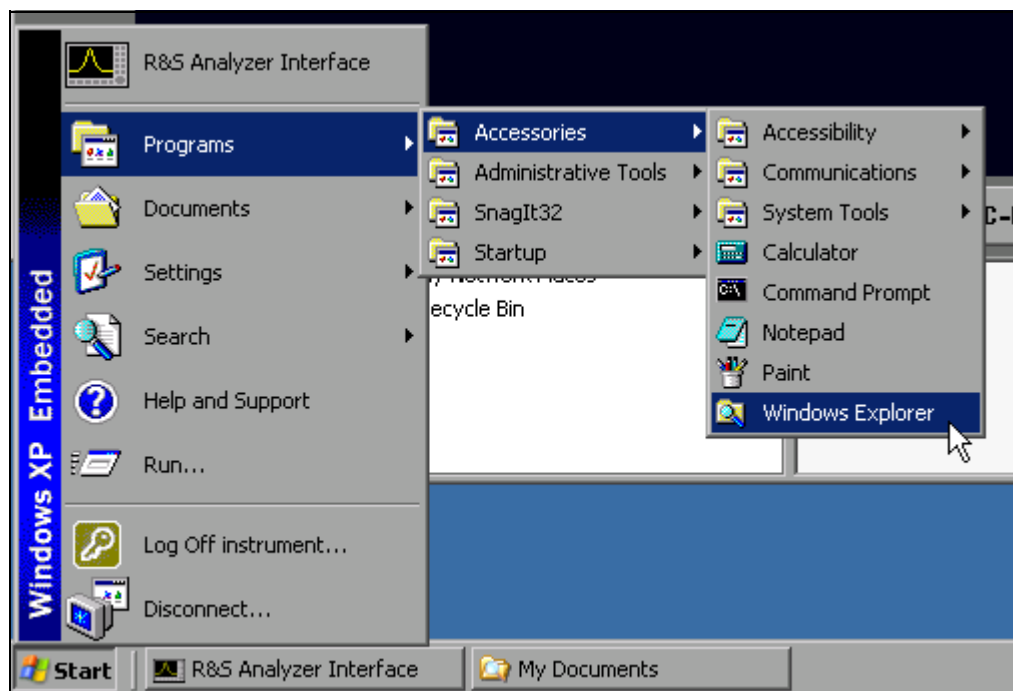

- Click *Programs - Accessories - Windows Explorer* to open Windows Explorer.

Operating the Instrument in a Network

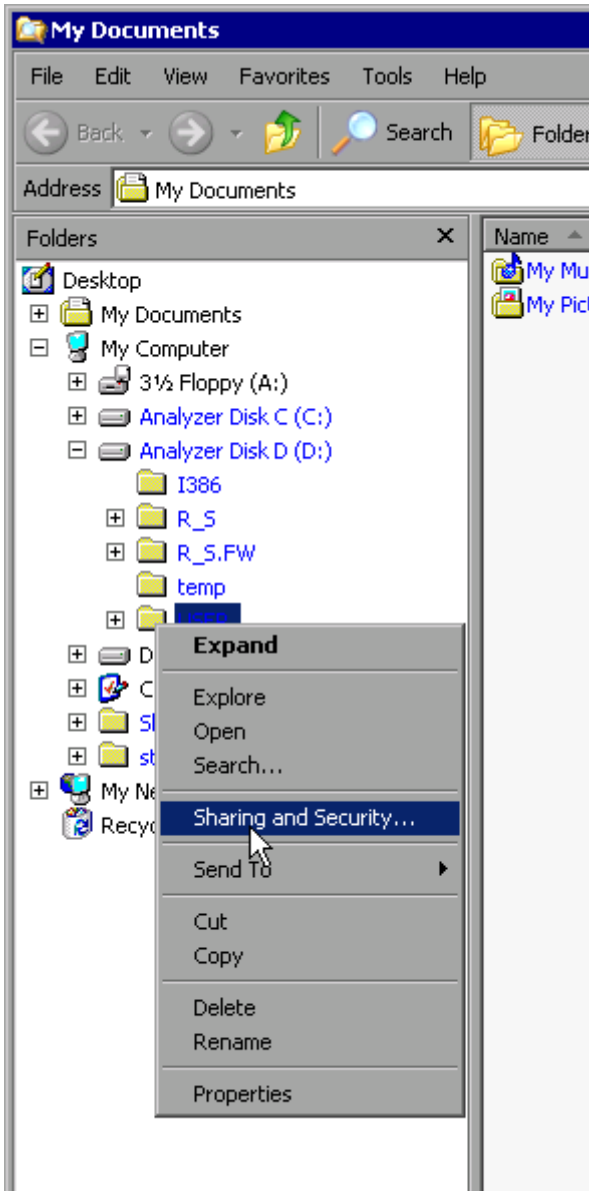

- Click the desired folder with the right mouse button.
- Click *Sharing and Security*.
The dialog for sharing the directory will open.

Operating the Instrument in a Network

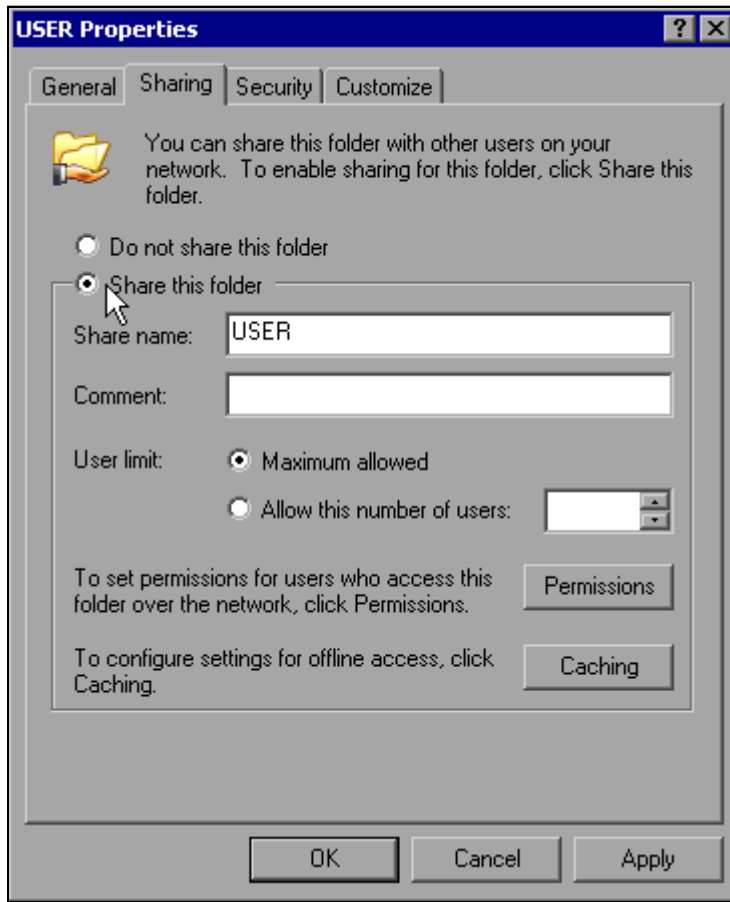

- Click *Share this folder*.
- You can change the following settings as necessary:
 - Share name*: Name under which the directory appears in Explorer
 - Comment*: Comments regarding the shared directory
 - User Limit*: Maximum number of users who can access the directory simultaneously
 - Permissions*: The user access rights (read only, read and write, all)
 - Caching*: Local buffering of the directory contents for quicker access
- Confirm the settings with *OK*.
The drive will be shared and marked with a hand under the directory symbol in Explorer:



Manual Operation of the R&S FSP with XP Remote Desktop

6.7 Manual Operation of the R&S FSP with XP Remote Desktop

6.7.1 Introduction

In production test and measurement, a common requirement is central monitoring of the T&M instruments for remote maintenance and remote diagnostics. Equipped with the Remote Desktop software of Windows XP, the R&S FSP ideally meets requirements for use in production:

- Access to the control functions via a virtual front panel (*soft front panel*)
- Printout of measurement results directly from the controller
- Storage of measured data on the controller's hard disk

The R&S FSP is connected via a LAN, in which case Windows XP also supports a connection via a modem. This section describes the configuration of the R&S FSP and Remote Desktop Client of the control PC. Details on how to set up a modem connection are described in the Window XP documentation.

6.7.2 Configuring the R&S FSP for Use of XP Remote Desktop

To enable an external computer to access the Remote Desktop software of the R&S FSP, proceed as follows:

1. Determine the IP configuration of the network connection:

- Open the Windows XP Start menu with the Windows key or the *CTRL+ESC* key combination.

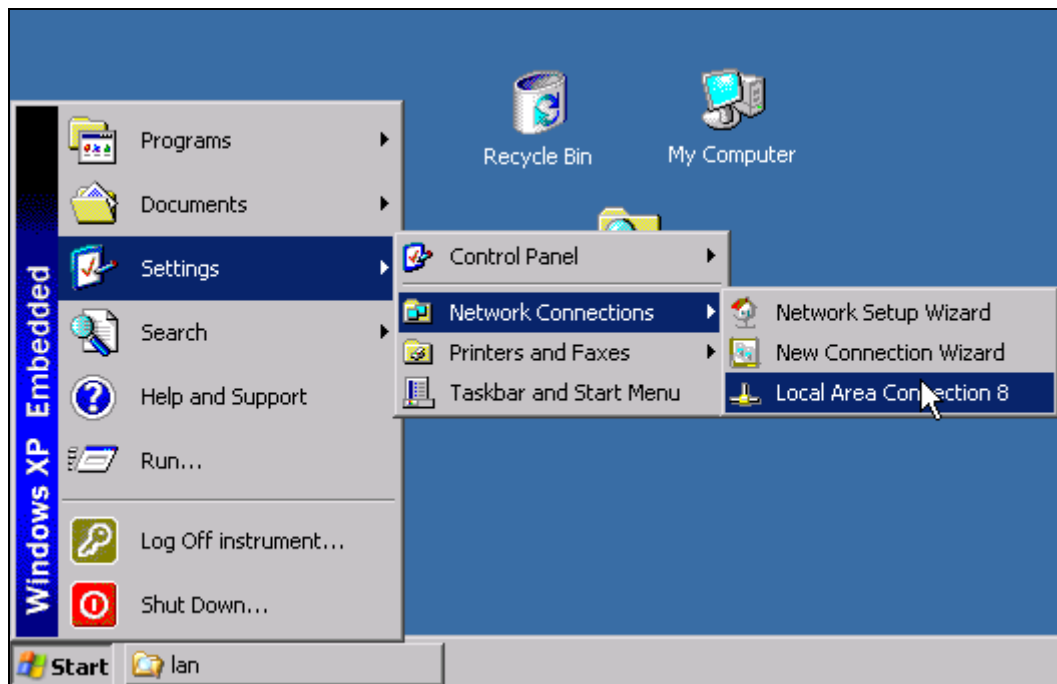

- Click *Settings - Network Connections - Local Area Connection*. The *Local Area Connection Status* dialog box will open.

Manual Operation of the R&S FSP with XP Remote Desktop

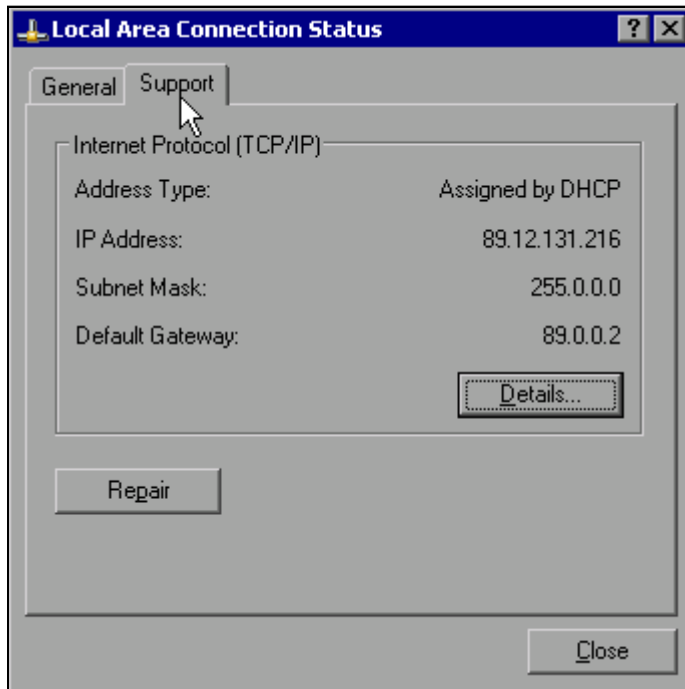

- Click the *Support* tab.
The current TCP/IP configuration will be displayed.

If *Assigned by DHCP* appears in the *Address Type* field, go to step 2 (Create a fixed IP address...). Otherwise, simply note the IP address and go to step 3 (Enable the R&S FSP...).

2. Create a fixed IP address for the TCP/IP protocol as described in the section “[Configuring Existing Network Protocols \(TCP/IP Protocol\)](#)” on page 2.31



To avoid problems, use a fixed IP address.

When a DHCP server is used, a new IP address is assigned each time the instrument is restarted. This address must first be determined on the instrument itself. Thus, using a DHCP server is not suitable for remote operation of the R&S FSP.

3. Enable the R&S FSP for operation with Remote Desktop

- Press the Windows key or *CTRL+ESC*.
The Windows Start menu will open.

Manual Operation of the R&S FSP with XP Remote Desktop

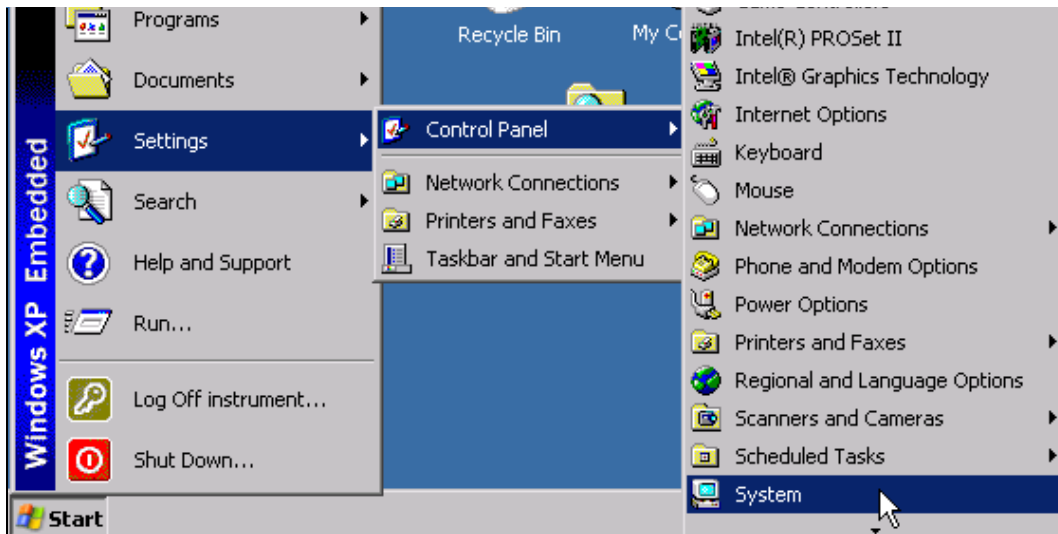

- Select *Settings - Control Panel - System*.
- Select the *Remote* tab.

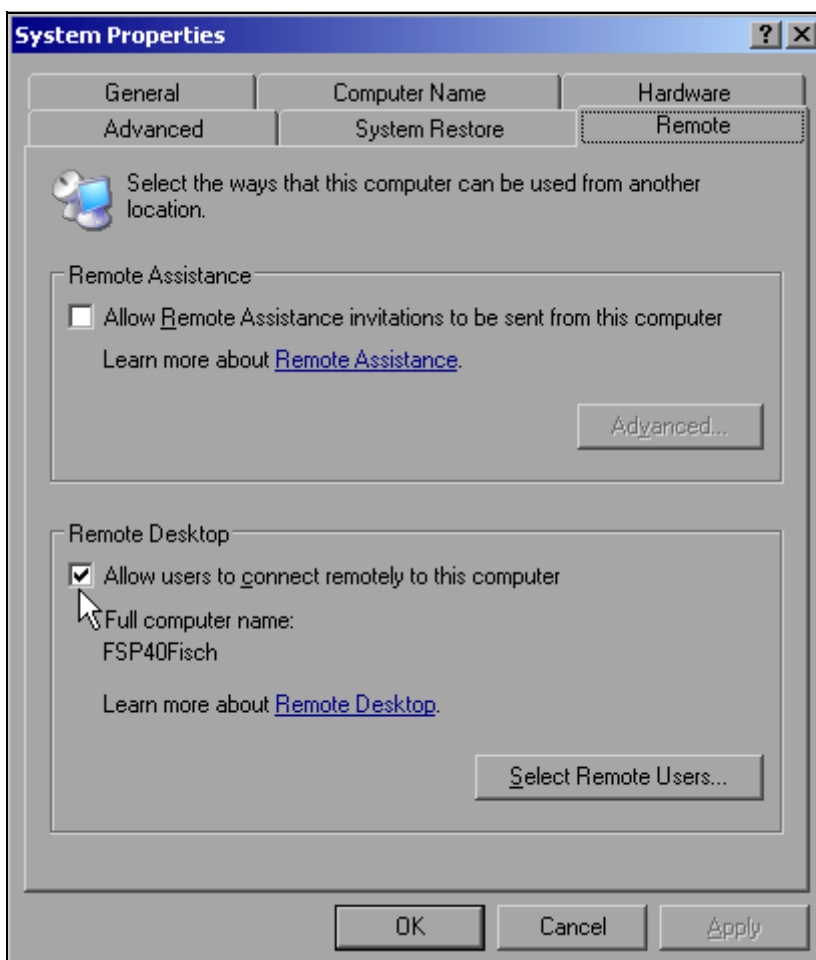

- In the *Remote Desktop* panel, select the check box in front of *Allow users to connect remotely to this computer*.

Manual Operation of the R&S FSP with XP Remote Desktop

- If necessary, click *Select Remote Users...* and select users created on the R&S FSP who are to be given access to the R&S FSP also via Remote Desktop.



The user account under which configuration is carried out is automatically enabled for Remote Desktop.

- Confirm the setting with *OK*.

The R&S FSP is now ready for connection setup with the Remote Desktop program of the controller.

6.7.3 Configuring the Controller

Before Remote Desktop can be operated, the TCP/IP protocol must be created on the controller and Remote Desktop Client must be installed.



With Windows XP, Remote Desktop Client is part of the operating system and can be accessed via *Start - Programs - Accessories - Communications - Remote Desktop Connection*.

For other versions of Windows, Microsoft offers the Remote Desktop Client as an add-on.

The settings on the Remote Desktop Client of the controller must be made before the connection with the R&S FSP is set up. The procedure is as follows:

- Press the Windows key or *CTRL+ESC*.

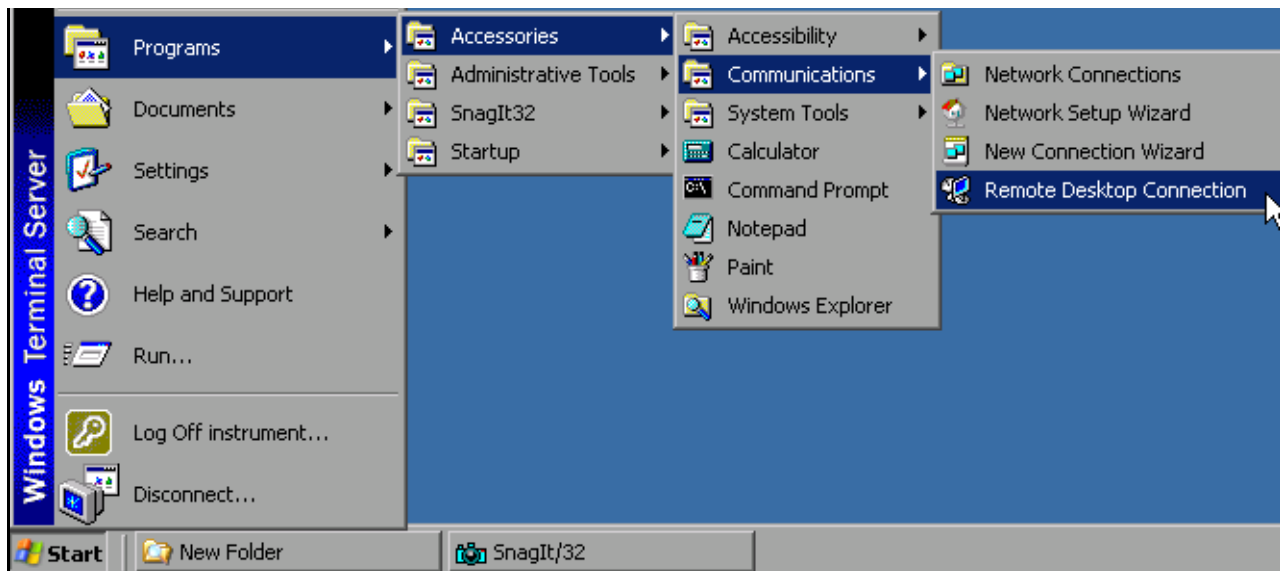

- Select *Programs - Accessories - Communications - Remote Desktop Connection*. The Remote Desktop login screen will appear.

Manual Operation of the R&S FSP with XP Remote Desktop

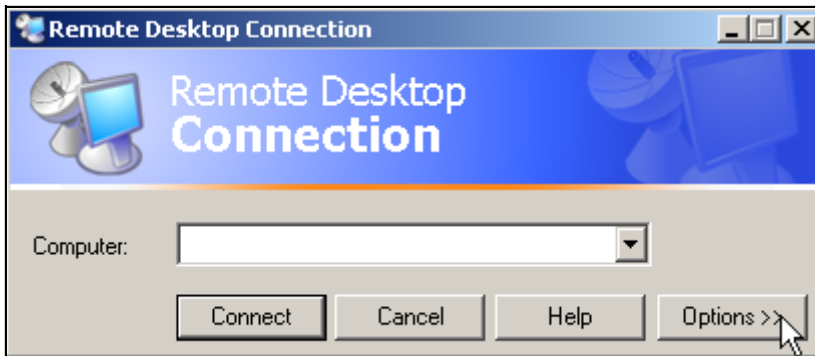

- Select the *Options >>* button.
The table with the configuration data will appear.



- Select the *Experience* tab.
These settings are used to select and optimize the connection speed.
- Click the selection list under *Choose your connection speed to optimize performance*.
The list of available configurations will appear.

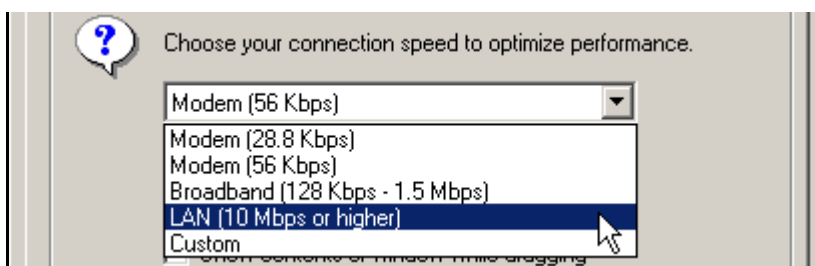

- Select the appropriate connection (for example: LAN (10 Mbps or higher)).
Depending on your selection, various checkboxes will be activated in the list located below (also depends on how powerful the connection is).
- To improve performance, you can deactivate *Desktop background*, *Show Contents of Window while dragging* and *Menu and Window animation*.
- Click the *Local Resources* tab.
The tab for enabling printers, local drives and serial interfaces will appear.

Manual Operation of the R&S FSP with XP Remote Desktop

- Click the check box in front of *Disk drives* if you will need to access drives of the controller from the R&S FSP (e.g. in order to store settings or to copy files from the controller to the R&S FSP):

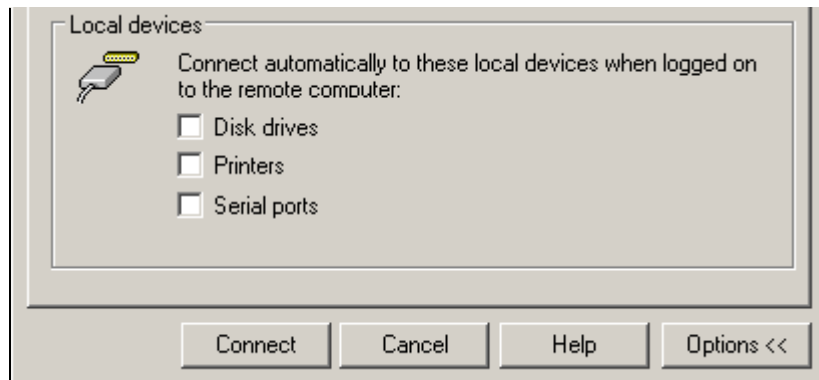

Windows XP will then map drives of the controller to the R&S FSP like network drives.

- Click the check box in front of *Printers* if you want to use printers connected to the controller by accessing them from the R&S FSP.
 - Do not change the remaining settings.
 - Click the *Display* tab.
- The options for configuring the R&S FSP screen display will appear.

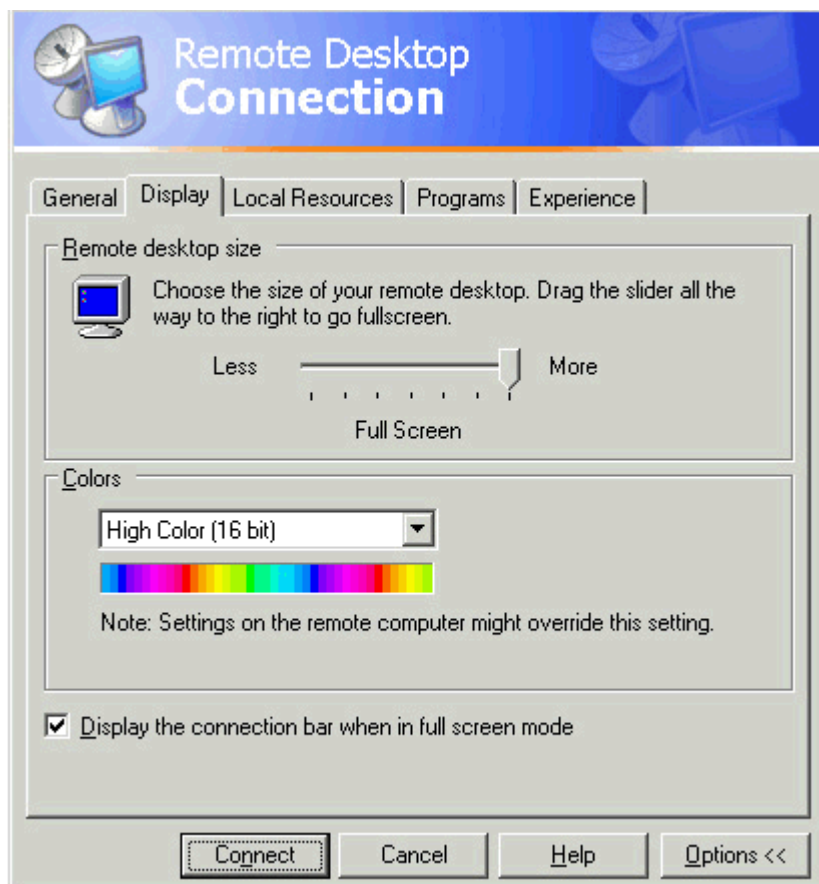

- You can set the size of the R&S FSP window on the desktop of the controller by positioning the pointer in the *Remote desktop size* panel. The default setting is Full Screen.

Manual Operation of the R&S FSP with XP Remote Desktop

- Do not change the *Colors* setting.
- Display the connection bar when in full screen mode:

If this option is enabled, a bar showing the network address of the R&S FSP will appear at the top edge of the screen. You can use this bar to reduce, minimize or close the window.

If this option is disabled, the only way you can return to the controller desktop from the R&S FSP screen in full screen mode is to select *Disconnect* from the Start menu:

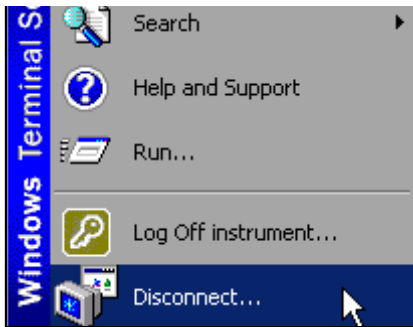

6.7.4 Connection Setup with the R&S FSP

After you configure the Remote Desktop Client, you need to set up the connection to the R&S FSP.

- Click the *General* tab. You can now enter the connection information.

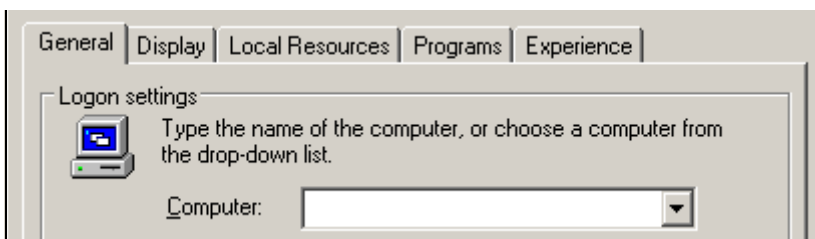

- Enter the IP address of the R&S FSP in the *Computer* field.
- You can save the connection information for later use by clicking the *Save As...* button. You can use the *Open...* button to load an existing connection configuration.

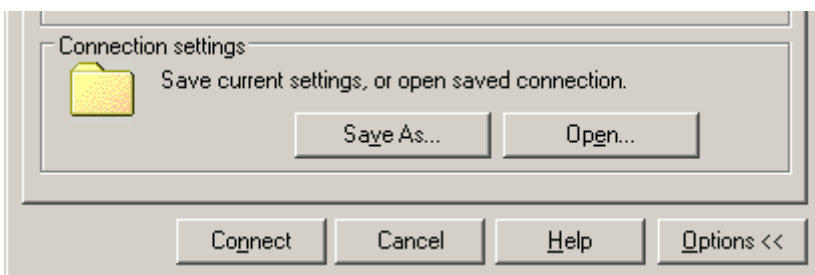

- Press the *Connect* button.
The connection will be set up.
- If the entry *Disk Drives* is enabled on the *Local Resources* tab, a warning will appear indicating that the drives are enabled for access from the R&S FSP:

Manual Operation of the R&S FSP with XP Remote Desktop



- Confirm the warning with **OK**.
Connection setup will be resumed.

After a few moments, the screen of the R&S FSP will appear on the controller's screen with the prompt for you to log on. To enable remote control of the R&S FSP, do the following:



- Enter "instrument" as the *user name* and "123456" as the *password*.
After a few moments, the R&S FSP screen will appear.



By default, the username is "instrument" and the password is "123456".
Prior to firmware version 4.4, the username and password both were "instrument".

If the R&S FSP application appears on screen immediately after connection setup, shutdown and restart are not necessary.

If a dark screen appears or a dark square appears in the upper left-hand corner of the screen, you must restart the R&S FSP in order to see the modified screen resolution:

Manual Operation of the R&S FSP with XP Remote Desktop

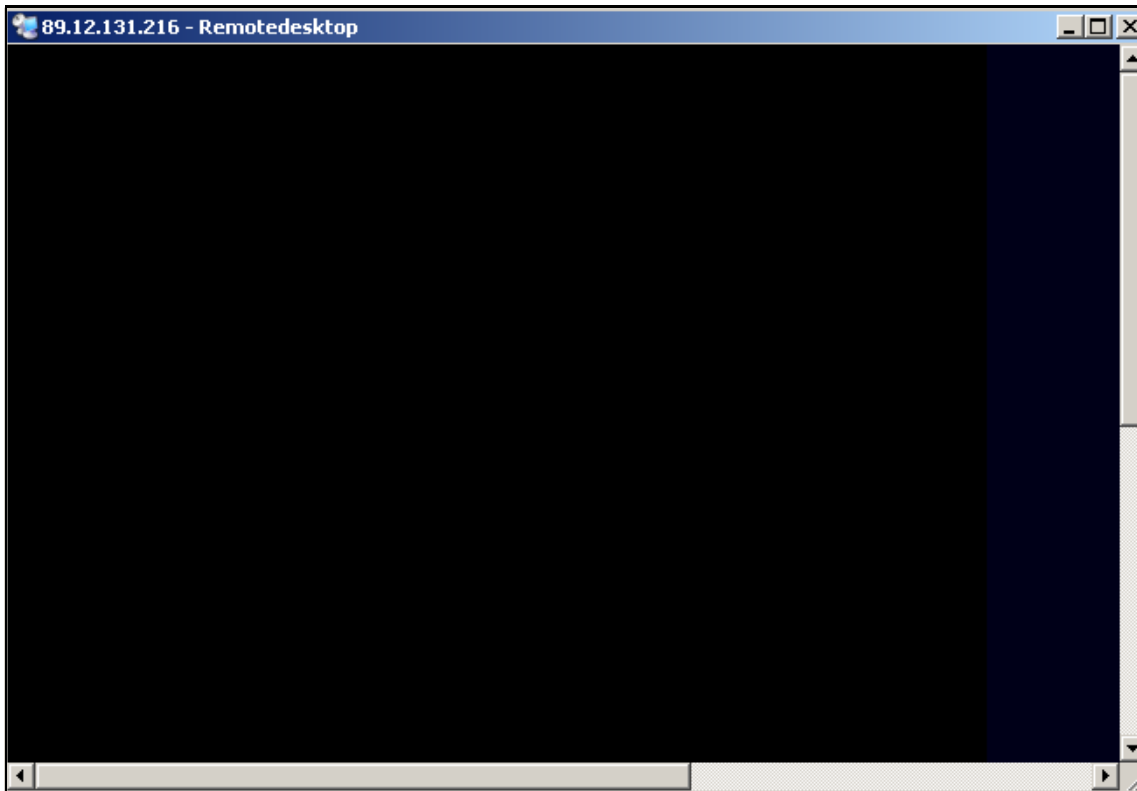

In this case, do the following:

- Press *ALT+F4*.

The R&S FSP firmware will be shut down, which may take a few seconds.

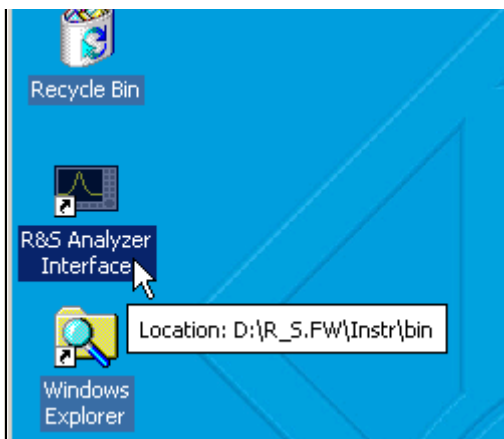

- Double-click *R&S Analyzer Interface*.

The firmware will restart and then automatically open the *Soft Front Panel*, i.e. the user interface on which all front panel controls and the rotary knob are mapped to buttons.

After the connection is established the R&S FSP screen is displayed in the Remote Desktop application window.

Manual Operation of the R&S FSP with XP Remote Desktop

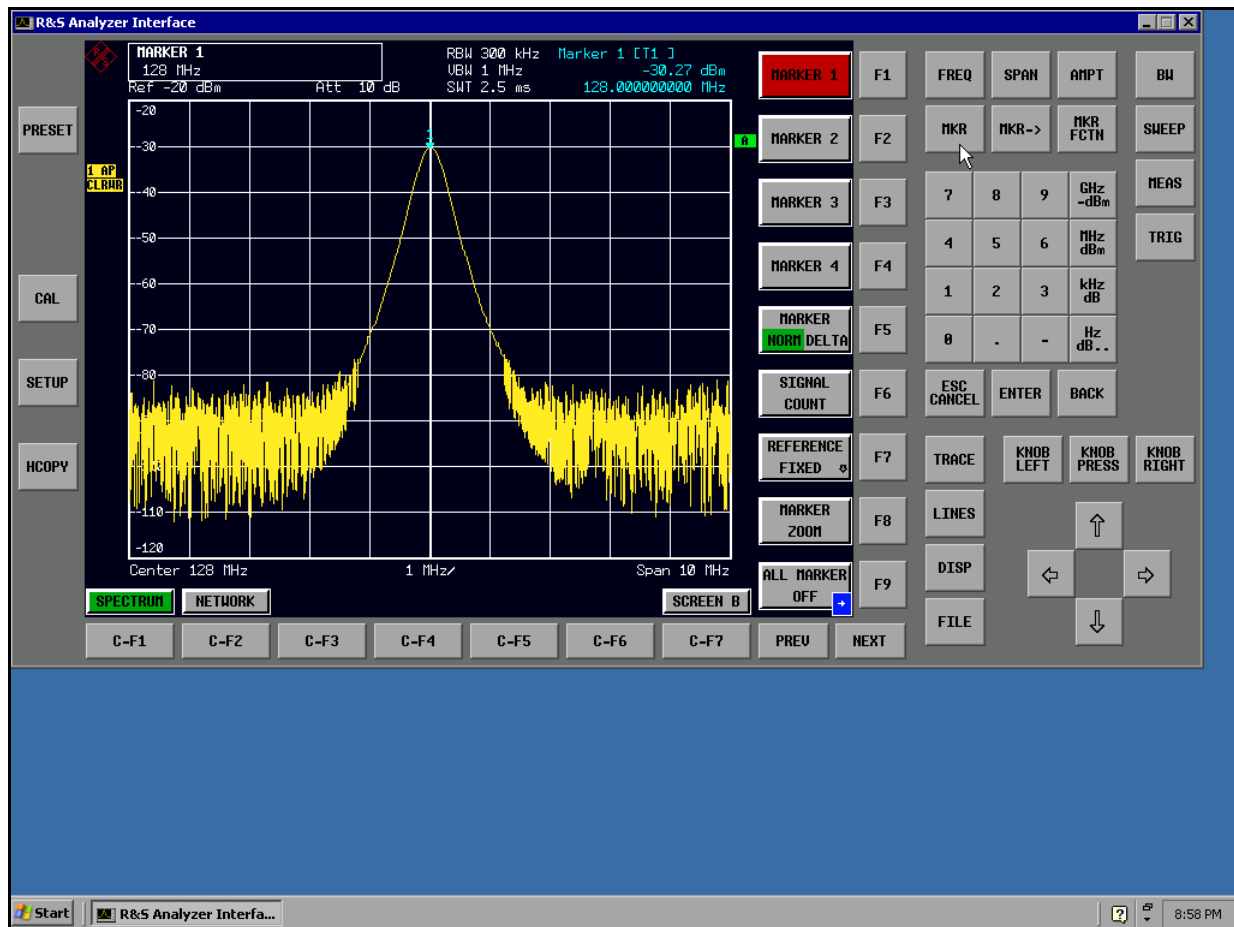

You can operate all hardkeys, softkeys and hotkeys by using the mouse.

The rotary knob is simulated by means of the *KNOB LEFT*, *KNOB RIGHT* and *KNOB PRESS* buttons.

The Windows XP Start menu can be made available by expanding the Remote Desktop window to Full Size.

6.7.5 Interrupting and Restoring the Remote Desktop Connection with the R&S FSP

The connection to the R&S FSP can be interrupted at any time by closing the Remote Desktop window on the controller.

To restore the connection with the R&S FSP, merely follow the instructions provided in the section “[Connection Setup with the R&S FSP](#)” on page 6.30. If the connection is interrupted and then restored, the R&S FSP remains in the same state.

During the connection with the controller, the login entry will appear on the R&S FSP screen. If the login procedure is completed successfully on the instrument, a message will appear on the controller display indicating that another user has assumed control of the instrument and that the connection was terminated as a result.

Manual Operation of the R&S FSP with XP Remote Desktop

6.7.6 Deactivating the R&S FSP from the Controller

The R&S FSP can be deactivated via remote control. To do so, proceed as follows:

1. Click the R&S FSP soft front panel and close the application with *ALT+F4*.
2. Click the desktop and press *ALT+F4*.
A safety query will appear that warns you that the instrument cannot be reactivated via remote control and asks you whether you want to continue the shutdown process.
3. Respond to the safety query with YES.
The connection with the controller will then be terminated and the R&S FSP will be deactivated.

7 Brief Introduction to Remote Control

7.1 Basic Steps in Programming using the VISA Interface . . .	7.3
7.1.1 Linking the VISA Library for Visual Basic	7.3
7.1.1.1 Programming notes:	7.3
7.1.2 Initialization and Default State	7.4
7.1.2.1 Creating Global Variables	7.4
7.1.2.2 Initializing the Controller	7.5
7.1.2.3 Initializing the Instrument	7.5
7.1.2.4 Switching the Screen Display On and Off	7.5
7.1.2.5 Configuring the Power Save Function for the Display	7.6
7.1.3 Sending Simple Instrument Setting Commands	7.6
7.1.4 Reading Out Instrument Settings	7.7
7.1.5 Marker Positioning and Readout	7.7
7.1.6 Command Synchronization	7.8
7.1.6.1 Reading Output Buffers	7.9
7.1.6.2 Reading Error Messages	7.9
7.2 Detailed Programming Examples	7.9
7.2.1 Default Settings of the R&S FSP	7.9
7.2.1.1 Setting the IEC Bus Status Registers	7.10
7.2.1.2 Default Settings for Measurements	7.10

7.2.2 Using Markers and Delta Markers	7.12
7.2.2.1 Marker Search Functions, Restricting the Search Range	7.12
7.2.2.2 Frequency Counting	7.13
7.2.2.3 Working with a Fixed Reference Point (Reference Fixed)	7.14
7.2.2.4 Measuring Noise and Phase Noise	7.15
7.2.3 Reading Out Trace Data	7.16
7.2.4 Storing and Loading Instrument Settings	7.18
7.2.4.1 Storing Instrument Settings	7.18
7.2.4.2 Loading Instrument Settings	7.19
7.2.4.3 Setting the Data Record for Startup Recall	7.20
7.2.5 Configuring and Starting a Printout	7.20
7.3 Installing USB Printers	A.2
7.4 Installing Non-Plug&Play Printers	A.6
7.4.1 Local Printer	A.6
7.4.2 Network Printer	A.12
7.5 List of Generator Types Supported by the R&S FSP	B.1

Basic Steps in Programming using the VISA Interface

The instrument can be remote controlled via the GPIB interface. For details on setting the GPIB interface see chapter 2, section “[Setting the GPIB Interface](#)” on page 2.20.

Remote control via network (LAN interface) is provided with option R&S FSP-B16 only. For details on configuring the LAN interface see chapter 2, section “[Configuring the LAN Interface \(Option R&S FSP-B16 only\)](#)” on page 2.30.

The following programming examples are hierarchical in structure, i.e. the later examples are based on the preceding ones. This makes it possible to easily assemble a well-functioning program by using the modules of the program examples. More complex examples are provided in the Operating Manual, chapter 7.

The chapter is divided into the following sections:

- “[Basic Steps in Programming using the VISA Interface](#)” on page 7.3
- “[Detailed Programming Examples](#)” on page 7.9

7.1 Basic Steps in Programming using the VISA Interface

The following examples explain how to program the instrument and can be used as a basis for solving enhanced programming tasks.

Visual Basic was used as the programming language. However, the programs can be implemented in other languages as well.



In programming languages as C, C++ or programmes as MATLAB, NI Interactive Control, a backslash starts an escape sequence (e.g. “\n” is used to start a new line). In these programming languages and programs, two backslashes instead of one must be used in remote commands, e.g. in “[Storing Instrument Settings](#)” on page 7.18:

```
instead of MMEM:STOR:STAT 1, 'D:\USER\DATA\TEST1 '  
use MMEM:STOR:STAT 1, 'D:\\USER\\DATA\\TEST1 '
```

7.1.1 Linking the VISA Library for Visual Basic

7.1.1.1 Programming notes:

Outputting texts by using the "Print" function

The following programming examples are based on the assumption that all subroutines are created as part of a form (file extension .FRM). In this case, the following notation is permitted:

```
Print "Text"
```

However, if the subroutines are created as a module (file extension .BAS), the name of the form that contains the required print method must be placed in front of the print instruction. Thus, if a form is named "Main", the print instruction will be as follows:

```
Main.Print "Text".
```

Basic Steps in Programming using the VISA Interface

Accessing the functions of the VISA32.DLL

To enable users to create Visual Basic control applications, the file dynamic link library VISA32.DLL has to be added to the project using the *References* command in the *Project* menu. In addition, the file VISA32.BAS is being added to the project. This file contains constants and definitions for error handling, time-out values, etc.

Declaring the DLL functions as procedures

All functions return a status variable that is defined as `Long`. Thus, all functions are declared in the file VISA32.BAS as follows:

```
Declare Function xxx Lib "visa32.dll" ( ... ) As Long
```

Creating a response buffer

Since the DLL returns zero-terminated strings in responses, a string of sufficient length must be created before the `viRead()` function is called, because Visual Basic inserts a length specification in front of the strings and this specification is not updated by the DLL. The following two means of creating the length specification for a string are provided:

```
Dim Rd as String * 100  
Dim Rd as String  
Rd = Space$(100)
```

7.1.2 Initialization and Default State

At the beginning of each program, the VISA resource manager has to be initialized. It opens a connection to the VISA driver itself, which controls the interaction with all instruments.

7.1.2.1 Creating Global Variables

In Visual Basic, global variables are stored in modules (data extension .BAS). Thus, at least one module (e.g. GLOBALS.BAS) must be created that contains the variables used by all subroutines, e.g. the variables for device handlers used by the VISA layer.

For all example programs shown below, the file must contain the following instructions:

```
Global analyzer As ViSession  
Global defaultRM As ViSession  
Const analyzerString = "GPIB0::20::INSTR"  
Const analyzerTimeout = 10000
```

The constant `analyzerString`, specifies the instrument. "GPIB0" specifies the control, whereas "20" specifies a certain instrument connected to the controller. Assuming the instrument was connected via a LAN cable and assigned the IP address 192.168.1.1, the corresponding string would read as:

```
Const analyzerString = "TCPIP::192.168.1.1::INSTR"
```

Basic Steps in Programming using the VISA Interface

7.1.2.2 Initializing the Controller

This procedure first establishes a connection to the VISA layer and then to the instrument specified by the analyzerString.

```

REM ----- Initializing the controller -----
Public SUB InitController()
Dim status As ViStatus
status = viOpenDefaultRM(defaultRM)
status = viOpen(defaultRM, analyzerString, VI_NULL, VI_NULL, analyzer)
    'Opens connection to Default Resource Manager and returns a handle to it
END SUB
REM *****

```

7.1.2.3 Initializing the Instrument

The instrument is set to its default settings and the status register is cleared.

```

REM ----- Initializing the instrument -----
Public SUB InitDevice()
Dim status As ViStatus
Dim retCnt As Long
status = viWrite(analyzer, "*CLS", 4, retCnt)           'Reset status register
status = viWrite(analyzer, "*RST", 4, retCnt)         'Reset instrument
END SUB
REM*****

```

7.1.2.4 Switching the Screen Display On and Off

In the default setting, all remote control commands are carried out with the screen display switched off in order to attain optimum measurement speed. During the development phase of remote control programs, however, the screen display is required in order to visually check both the programming of the settings and the measurement results.

The following examples show functions that switch the screen display on or off during remote control.

```

REM ----- Switching on the screen display -----
Public SUB DisplayOn()
Dim status As ViStatus
Dim retCnt As Long
status = viWrite(analyzer, "SYST:DISP:UPD ON", 16, retCnt)
    'Switch on screen display
END SUB
REM*****
REM ----- Switching off the screen display -----
Public SUB DisplayOff()
Dim status As ViStatus
Dim retCnt As Long
status = viWrite(analyzer, "SYST:DISP:UPD OFF", 17, retCnt)
    'Switch off screen display
END SUB

```

Basic Steps in Programming using the VISA Interface

REM*****

7.1.2.5 Configuring the Power Save Function for the Display

During remote operation, it is often unnecessary to display the measurement results on screen. Although the `SYSTEM:DISPlay:UPDate OFF` command switches off the display of the measurement results, thus significantly improving speed during remote control, the display itself and the background lighting in particular remain switched on.

If you also want to switch off the display itself, you must use the Power Save function by setting the response time in minutes prior to activation.



The display will be immediately reactivated if you press a key on the instrument's front panel.

REM ----- Switching on Power Save function -----

Public SUB PowerSave ()

Dim status As ViStatus

Dim retCnt As Long

status = viWrite(analyzer, "DISP:PSAV:HOLD 1", 16, retCnt)

'Set response time to 1 minute

status = viWrite(analyzer, "DISP:PSAV ON", 12, retCnt)

'Switch on Power Save function

END SUB

REM*****

7.1.3 Sending Simple Instrument Setting Commands

This example shows how the center frequency, span and reference level of the instrument are set.

REM ----- Instrument setting commands -----

PUBLIC SUB SimpleSettings ()

Dim status As ViStatus

Dim retCnt As Long

status = viWrite(analyzer, "FREQUENCY:CENTER 128MHz", 22, retCnt)

'Center frequency 128 MHz

status = viWrite(analyzer, "FREQUENCY:SPAN 10MHZ", 19, retCnt)

'Set span to 10 MHz

status = viWrite(analyzer, "DISPLAY:TRACE:Y:RLEVEL -10dBm", 29, retCnt)

'Set reference level to -10dBm

END SUB

REM *****

Basic Steps in Programming using the VISA Interface

7.1.4 Reading Out Instrument Settings

The settings made above can now be read out. To do so, the abbreviated commands are used.

```

REM ----- Reading out instrument settings -----
PUBLIC SUB ReadSettings()
Dim status As ViStatus
Dim retCnt As Long
CFfrequenz$ = Space$(20)           'Provide text variable (20 characters)
status = viWrite(analyzer, "FREQ:CENT?", 10, retCnt)
                                   'Request center frequency
status = viRead(analyzer, CFfrequenz$, 20, retCnt)
                                   'Read in value
CFspan$ = Space$(20)               'Provide text variable (20 characters)
status = viWrite(analyzer, "FREQ:SPAN?", 10, retCnt)
                                   'Request span
status = viRead(analyzer, CFspan$, 20, retCnt)
                                   'Read in value
RLpegel$ = Space$(20)             'Provide text variable (20 characters)
status = viWrite(analyzer, "DISP:TRAC:Y:RLEV?", 17, retCnt)
                                   'Request ref level setting
status = viRead(analyzer, RLpegel$, 20, retCnt)
                                   'Read in value
REM ----- Displaying values on the screen -----
Print "Center frequency: "; CFfrequenz$,
Print "Span:                "; CFspan$,
Print "Reference level:    "; RLpegel$,
END SUB
REM*****

```

7.1.5 Marker Positioning and Readout

```

REM ----- Example of marker function -----
PUBLIC SUB ReadMarker()
status = viWrite(analyzer, "CALC:MARKER ON;MARKER:MAX", 25, retCnt)
                                   'Activate marker 1 and search for peak
MKmark$ = Space$(30)              'Provide text variable (30 characters)
status = viWrite(analyzer, "CALC:MARK:X?;Y?", 15, retCnt)
status = viRead(analyzer, MKmark$, 30, retCnt)
                                   'Query frequency and level and read in value
REM ----- Displaying values on the screen -----
Print "Marker frequency/level "; MKmark$,
END SUB
REM *****

```

Basic Steps in Programming using the VISA Interface

7.1.6 Command Synchronization

The synchronization methods used in the following example are described in the Operating Manual, chapter 5, section "Command Sequence and Command Synchronization".



Service requests are only supported by GPIB and VXI instruments.

```

REM ----- Commands for command synchronization -----
PUBLIC SUB SweepSync ()
Dim status As ViStatus
Dim retCnt As Long
Dim etype As ViEventType
Dim eevent As ViEvent
Dim stat As Integer
Rem The command INITiate[:IMMEDIATE] starts a single sweep if the
Rem command INIT:CONT OFF has already been sent. The next command
Rem must not be carried out until a full sweep has been completed.
status = viWrite(analyzer, "INIT:CONT OFF", 13, retCnt)
REM ----- First method: Using *WAI -----
status = viWrite(analyzer, "ABOR;INIT:IMM;*WAI", 18, retCnt)
REM ----- Second method: Using *OPC? -----
OpcOk$ = Space$(2)
status = viWrite(analyzer, "ABOR;INIT:IMM; *OPC?", 20, retCnt)
                                'Provide space for *OPC? response
REM In this case, the controller can use other instruments:
status = viRead(analyzer, OpcOk$, 2, retCnt)
                                'Wait for "1" from *OPC?
REM ----- Third method: Using *OPC -----
Rem In order for the Service Request function to be used with a GPIB
Rem driver from National Instruments, the setting
Rem "Disable Auto Serial Poll" must be set to "yes" with IBCONF!
status = viWrite(analyzer, "*SRE 32", 7, retCnt)
                                'Enable Service Request for ESR
status = viWrite(analyzer, "*ESE 1", 6, retCnt)
                                'Set event enable bit for operation complete bit
status = viEnableEvent(analyzer, VI_EVENT_SERVICE_REQ, VI_QUEUE, VI_NULL)
                                'Enable SRQ event
status = viWrite(analyzer, "ABOR;INIT:IMM;*OPC", 18, retCnt)
                                'Start sweep with synchronization to OPC
status = viWaitOnEvent(analyzer, VI_EVENT_SERVICE_REQ, 10000, etype, eevent)
                                'Wait for Service Request
status = viReadSTB(analyzer, stat)
status = viClose(eevent)
                                'Close event handler
status = viDisableEvent(analyzer, VI_EVENT_SERVICE_REQ, VI_QUEUE)
                                'Disable SRQ Event
REM Resume main program here.

```

```
END SUB
REM *****
```

7.1.6.1 Reading Output Buffers

```
REM ----- Subroutine for the individual STB bits -----
Public SUB Outputqueue()           'Reading the output queue
Dim status As ViStatus
Dim retCnt As Long
result$ = Space$(100)             'Create space for response
status = viRead(analyzer, result$, 100, retCnt)
Print "Contents of Output Queue : "; result$
END SUB
REM *****
```

7.1.6.2 Reading Error Messages

```
REM ----- Subroutine for evaluating the error queue -----
Public SUB ErrorQueueHandler()
Dim status As ViStatus
Dim retCnt As Long
sError$ = Space$(100)             'Subroutine for evaluating the error queue
status = viWrite(analyzer, "SYSTEM:ERROR?", 13, retCnt)
status = viRead(analyzer, sError$, 100, retCnt)
Print "Error Description : "; sError$
END SUB
REM *****
```

7.2 Detailed Programming Examples

7.2.1 Default Settings of the R&S FSP

The following settings provide typical examples of how to change the default settings of the R&S FSP.

Note that only some of the settings are necessary depending on the application example. In many cases, it is not necessary to set resolution bandwidth, video bandwidth and sweep time since these parameters are automatically calculated in the default setting when the span is changed. Likewise, the input attenuation is automatically calculated in the default setting as a function of the reference level. Last of all, the level detectors are linked to the selected trace mode in the default setting.

The settings automatically calculated in the default setting are indicated with an asterisk (*) in the following program example.

7.2.1.1 Setting the IEC Bus Status Registers

```

REM *****
Public Sub SetupStatusReg()
Dim status As ViStatus
Dim retCnt As Long
REM ----- IEEE 488.2 status register -----
status = viWrite(analyzer, "*CLS", 4, retCnt)
                'Reset status registers
status = viWrite(analyzer, "*SRE 168", 8, retCnt)
                'Enable Service Request for STAT:OPER-,
                'STAT:QUES- and ESR-Register
status = viWrite(analyzer, "*ESE 61", 7, retCnt)
                'Set event enable bit for:
                'operation complete
                'command-, execution-, device
                'dependent- and query error

REM ----- SCPI status register -----
status = viWrite(analyzer, "STAT:OPER:ENAB 0", 16, retCnt)
                'Disable OPERation Status Register
status = viWrite(analyzer, "STAT:QUES:ENAB 0", 16, retCnt)
                'Disable QUEStionable Status Register

End Sub
REM *****

```

7.2.1.2 Default Settings for Measurements

```

REM *****
Public Sub SetupInstrument()
Dim status As ViStatus
Dim retCnt As Long
REM ----- Default setting of the R&S FSP -----
Call SetupStatusReg                'Configure status registers
status = viWrite(analyzer, "*RST", 4, retCnt)
                'Reset instrument
status = viWrite(analyzer, "SYST:DISP:UPD ON", 16, retCnt)
                'ON: screen display on, OFF: off (improved performance)
status = viWrite(analyzer, "DISP:FORM SINGLE", 16, retCnt)
                'Full screen display
status = viWrite(analyzer, "DISP:WIND1:SEL", 14, retCnt)
                'Active Screen A
status = viWrite(analyzer, "INIT:CONT OFF", 13, retCnt)
                'Single sweep mode

REM ----- Frequency setting -----
status = viWrite(analyzer, "FREQUENCY:CENTER 100MHz", 23, retCnt)
                'Center frequency
status = viWrite(analyzer, "FREQ:SPAN 1 MHz", 15, retCnt)
                'Span

REM ----- Level setting -----

```

Detailed Programming Examples

```

status = viWrite(analyzer, "DISP:WIND:TRAC:Y:RLEV -20dBm", 28, retCnt)
                'Reference level
status = viWrite(analyzer, "INP:ATT 10dB", 12, retCnt)
                'Input attenuation  (*)

REM ----- Level scaling -----
status = viWrite(analyzer, "DISP:WIND:TRAC:Y:SPAC LOG", 25, retCnt)
                'Log level axis
status = viWrite(analyzer, "DISP:WIND:TRAC:Y:SCAL 100dB", 27, retCnt)
                'Level range
status = viWrite(analyzer, "DISP:WIND:TRAC:Y:SCAL:MODE ABS", 30, retCnt)
                'Absolute scaling
status = viWrite(analyzer, "CALC:UNIT:POW DBM", 17, retCnt)
                'y meas. unit

REM ----- Trace and detector setting -----
status = viWrite(analyzer, "DISP:WIND:TRAC1:MODE AVER", 25, retCnt)
                'Trace1 average
status = viWrite(analyzer, "AVER:TYPE VID", 13, retCnt)
                'Average mode video; "VID" for video
status = viWrite(analyzer, "SWE:COUN 10", 11, retCnt)
                'Sweep count
status = viWrite(analyzer, "DISP:WIND:TRAC2:STAT OFF", 24, retCnt)
                'Trace2 blank
status = viWrite(analyzer, "DISP:WIND:TRAC3:STAT OFF", 24, retCnt)
                'Trace3 blank
status = viWrite(analyzer, "CALC:MATH:STAT OFF", 18, retCnt)
                'Trace difference off
status = viWrite(analyzer, "DETECTOR1 RMS", 13, retCnt)
                'Detector Trace1  (*)
status = viWrite(analyzer, "DET2:AUTO ON", 12, retCnt)
                'Detector Trace2  (*)
status = viWrite(analyzer, "DET3:AUTO ON", 12, retCnt)
                'Detector Trace3  (*)

REM ----- Bandwidths and sweep time -----
status = viWrite(analyzer, "BAND:RES 100KHz", 15, retCnt) 'Resolution bandwidth (*)
status = viWrite(analyzer, "BAND:VID 1MHz", 13, retCnt)  'Video bandwidth  (*)
status = viWrite(analyzer, "SWE:TIME 100ms", 14, retCnt) 'Sweep time          (*)
END SUB
REM *****

```

7.2.2 Using Markers and Delta Markers

7.2.2.1 Marker Search Functions, Restricting the Search Range

The following example is based on an AM-modulated signal at 100 MHz that has the following characteristics:

- Carrier signal level: -30 dBm
- AF frequency: 100 kHz
- Modulation depth: 50%

Marker 1 and then delta marker 2 are set to the largest maximum points on the trace. The frequency and level are then read. In the following measurements, the instrument's default setting can be used for measurements (SetupInstrument).

```

REM *****
Public Sub MarkerSearch()
Dim status As ViStatus
Dim retCnt As Long
result$ = Space$(100)
Call SetupInstrument          'Default Setting
REM ----- Peak search without search range limits-----
status = viWrite(analyzer, "INIT:CONT OFF", 13, retCnt)
                        'Switch to single sweep
status = viWrite(analyzer, "CALC:MARK:PEXC 6DB", 18, retCnt)
                        'Define peak excursion
status = viWrite(analyzer, "CALC:MARK:STAT ON", 17, retCnt)
                        'Enable marker 1
status = viWrite(analyzer, "CALC:MARK:TRAC 1", 16, retCnt)
                        'Set marker 1 to trace 1
status = viWrite(analyzer, "INIT;*WAI", 9, retCnt)
                        'Perform sweep with sync
status = viWrite(analyzer, "CALC:MARK:MAX;X?;Y?", 19, retCnt)
                        'Marker to peak; read frequency and level
status = viRead(analyzer, result$, 100, retCnt)
Print "Marker 1: "; result$
status = viWrite(analyzer, "CALC:DELT2:STAT ON;MAX;MAX:LEFT", 31, retCnt)
                        'Activate delta marker 2, set to peak and then
                        'to next peak left
status = viWrite(analyzer, "CALC:DELT2:X?;Y?", 16, retCnt)
                        'Read delta marker 2 frequency and level
status = viRead(analyzer, result$, 100, retCnt)
Print "Delta 2: "; result$
REM ----- Peak search with search range limit in x direction -----
status = viWrite(analyzer, "CALC:MARK:X:SLIM:STAT ON;LEFT 0Hz;RIGHT 100.05MHz", 49,
retCnt)
                        'Activate search limit and set at right below AF
status = viWrite(analyzer, "CALC:DELT3:STAT ON;MAX;MAX:RIGHT", 32, retCnt)
                        'Activate delta marker 3, 'set to peak and then
                        'to next peak right

```

Detailed Programming Examples

```

status = viWrite(analyzer, "CALC:DELT3:X:REL?::CALC:DELT3:Y?", 32, retCnt)
                'Read delta marker 3 frequency and level;
                'both must have a value of 0
status = viRead(analyzer, result$, 100, retCnt)
Print "Delta 3: "; result$
REM ----- Peak search with search range limit in y direction -----
status = viWrite(analyzer, "CALC:THR:STAT ON", 16, retCnt)
status = viWrite(analyzer, "CALC:THR -35DBM", 15, retCnt)
                'Activate threshold and set it above the AF
status = viWrite(analyzer, "CALC:DELT3:STAT ON;MAX;MAX:NEXT", 31, retCnt)
                'Activate delta marker 3, set to peak and then
                'to next peak => is not found
status = viWrite(analyzer, "CALC:DELT3:X:REL?::CALC:DELT3:Y?", 32, retCnt)
                'Query and read delta marker 3 frequency and
                'level; both must have a value of 0
status = viRead(analyzer, result$, 100, retCnt)
Print "Delta 3: "; result$
REM - Setting center frequency and reference level with markers -----
status = viWrite(analyzer, "CALC:MARK2:FUNC:CENT", 20, retCnt)
                'Delta marker 2 -> marker and center frequency = marker 2
status = viWrite(analyzer, "CALC:MARK2:FUNC:REF", 19, retCnt)
                'Ref level = marker 2
status = viWrite(analyzer, "INIT;*WAI", 9, retCnt)
                'Sweep with sync

END SUB
REM *****

```

7.2.2.2 Frequency Counting

The following example is based on a signal at 100 MHz with a level of -30 dBm. Also in this measurement, the instrument's default setting can be used (SetupInstrument). The purpose of frequency counting is to determine the exact frequency of the signal at 100 MHz.

```

REM *****
Public Sub MarkerCount()

Dim status As ViStatus
Dim retCnt As Long

result$ = Space$(100)
Call SetupInstrument                'Default setting
REM ----- Defining signal frequency with frequency counter -----
status = viWrite(analyzer, "INIT:CONT OFF", 13, retCnt)
                'Switch to single sweep
status = viWrite(analyzer, "CALC:MARK:PEXC 6DB", 18, retCnt)
                'Define peak excursion
status = viWrite(analyzer, "CALC:MARK:STAT ON", 17, retCnt)
                'Activate marker 1

```

Detailed Programming Examples

```

status = viWrite(analyzer, "CALC:MARK:TRAC 1", 16, retCnt)
                'Set marker 1 to trace 1
status = viWrite(analyzer, "CALC:MARK:X 100MHz", 18, retCnt)
                'Set marker 1 to 100 MHz
status = viWrite(analyzer, "CALC:MARK:COUNT:RES 1HZ", 23, retCnt)
                'Set count resolution to 1 Hz
status = viWrite(analyzer, "CALC:MARK:COUNT ON", 18, retCnt)
                'Activate frequency counter
status = viWrite(analyzer, "INIT;*WAI", 9, retCnt)
                'Perform sweep with sync
status = viWrite(analyzer, "CALC:MARK:COUNT:FREQ?", 21, retCnt)
                'Query and read measured frequency
status = viRead(analyzer, result$, 100, retCnt)
Print "Marker Count Freq: "; result$

```

END SUB

REM *****

7.2.2.3 Working with a Fixed Reference Point (Reference Fixed)

The following example is based on a signal at 100 MHz with a level of -20 dBm. Thus, the harmonics of the signal are located at 200 MHz, 300 MHz, etc. In the case of high-quality signal sources, these harmonics may be located outside the dynamic range of the R&S FSP. Nevertheless, to measure the harmonic suppression, the level setting must be changed to higher sensitivity when measuring the harmonics, in which case it may be necessary to suppress the carrier by using a notch filter in order to prevent the RF input of the R&S FSP from being overloaded.

Thus, two measurements with different level settings are performed in the following example. First, a high reference level is used on the carrier frequency, and then a low reference level is used on the frequency of the third harmonic.

The default setting of the R&S FSP for measurements (SetupInstrument) is also used as a starting point here, after which adaptations for the measurement are carried out.

REM *****

Public Sub RefFixed()

Dim status As ViStatus

Dim retCnt As Long

result\$ = Space\$(100)

Call SetupInstrument 'Default setting

REM ----- Measuring the reference point -----

status = viWrite(analyzer, "INIT:CONT OFF", 13, retCnt)

'Switch to single sweep

status = viWrite(analyzer, "CALC:MARK:PEXC 6DB", 18, retCnt)

'Define peak excursion

status = viWrite(analyzer, "CALC:MARK:STAT ON", 17, retCnt)

'Activate marker 1

Detailed Programming Examples

```

status = viWrite(analyzer, "CALC:MARK:TRAC 1", 16, retCnt)
                        'Set marker 1 to trace 1
status = viWrite(analyzer, "INIT;*WAI", 9, retCnt)
                        'Perform sweep with sync
status = viWrite(analyzer, "CALC:MARK:MAX", 13, retCnt)
                        'Set marker 1 to 100 MHz
status = viWrite(analyzer, "CALC:DELT:FUNC:FIX ON", 21, retCnt)
                        'Define reference
REM -- Setting frequency, level and bandwidth for measuring harmonics -----
status = viWrite(analyzer, "FREQ:CENT 400MHz;Span 1MHz", 26, retCnt)
                        'Set freq of 3rd harmonic
status = viWrite(analyzer, "BAND:RES 1kHz", 13, retCnt)
                        'Set suitable RBW
status = viWrite(analyzer, "SWEEP:TIME:AUTO ON", 18, retCnt)
                        'Couple sweep time
status = viWrite(analyzer, "INP:ATT:AUTO ON", 15, retCnt)
status = viWrite(analyzer, "DISP:WIND:TRAC:Y:RLEV -50dBm", 28, retCnt)
                        'Select more sensitive level setting
status = viWrite(analyzer, "INIT;*WAI", 9, retCnt)
                        'Perform sweep with sync
status = viWrite(analyzer, "CALC:DELT:MAX;X:REL?;Y?", 23, retCnt)
                        'Read delta marker
status = viRead(analyzer, result$, 100, retCnt)
                        'Read frequency and level
Print "Deltamarker 1: "; result$

END SUB
REM *****

```

7.2.2.4 Measuring Noise and Phase Noise

When phase noise is measured, the noise power related to a bandwidth of 1 Hz is set in relation to the power of an adjacent carrier signal. A commonly used offset between the measured frequency and the carrier frequency is 10 kHz.

When noise is measured, the measured absolute level is related to a bandwidth of 1 Hz.

The following example is also based on a signal at 100 MHz with a level of -30 dBm. Two markers are used to determine both the noise and the phase noise at a 10 kHz offset from the carrier signal.

```

REM *****
Public Sub Noise()
Dim status As ViStatus
Dim retCnt As Long
result$ = Space$(100)
REM ----- Default setting of the R&S FSP -----
Call SetupStatusReg                                'Configure status register
status = viWrite(analyzer, "*RST", 4, retCnt)      'Reset instrument
status = viWrite(analyzer, "INIT:CONT OFF", 13, retCnt) 'Single sweep mode

```

```

REM ----- Setting the frequency -----
status = viWrite(analyzer, "FREQUENCY:CENTER 100MHz", 23, retCnt) 'Center frequency
status = viWrite(analyzer, "FREQ:SPAN 100 kHz", 17, retCnt)      'Span
REM ----- Setting the level -----
status = viWrite(analyzer, "DISP:WIND:TRAC:Y:RLEV -20dBm", 28, retCnt)
                                                'Reference level
status = viWrite(analyzer, "INIT;*WAI", 9, retCnt)              'Perform sweep with sync
REM ----- Setting the reference point -----
status = viWrite(analyzer, "CALC:MARK:PEXC 6DB", 18, retCnt)
                                                'Define peak excursion
status = viWrite(analyzer, "CALC:MARK:STAT ON", 17, retCnt)
                                                'Activate marker 1
status = viWrite(analyzer, "CALC:MARK:TRAC 1", 16, retCnt)
                                                'Set marker 1 to trace 1
status = viWrite(analyzer, "CALC:MARK:MAX", 13, retCnt)
                                                'Set marker 1 to 100 MHz
status = viWrite(analyzer, "CALC:DELT:FUNC:PNO ON", 21, retCnt)
                                                'Define reference point for phase noise
REM ----- Measuring the phase noise -----
status = viWrite(analyzer, "CALC:DELT:X 10kHz", 17, retCnt)
                                                'Position delta marker
status = viWrite(analyzer, "CALC:DELT:FUNC:PNO:RES?", 23, retCnt)
                                                'Query phase noise result
status = viRead(analyzer, result$, 100, retCnt)
Print "Phase Noise [dBc/Hz]: "; result$
REM ----- Measuring the noise -----
status = viWrite(analyzer, "CALC:MARK:X 99.96MHz", 20, retCnt)
                                                'Position marker 1
status = viWrite(analyzer, "CALC:MARK:FUNC:NOIS:RES?", 24, retCnt)
                                                'Query and output result
status = viRead(analyzer, result$, 100, retCnt)
Print "Noise [dBm/Hz]: "; result$
END SUB
REM *****

```

7.2.3 Reading Out Trace Data

In the following example, the trace data obtained with the default setting is read from the instrument and displayed in a list on screen. Readout occurs first in binary format and then in ASCII format, once with the span > 0 and once with the span = 0.

In binary format, the header of the message with the length specification is evaluated and used to calculate the x axis values.

In ASCII format, merely the list of level values is output.

Binary data is read out in three steps:

1. The number of digits in the length specification is read out.
2. The length specification itself is read out.

3. The trace data itself is read out.

The procedure is required in the case of programming languages that only support structures with data types of the same type (arrays) (such as with Visual Basic), because the data types of the header and data sections are different in binary data.

Note that the function viRead32 is not declared in VISA32.BAS and therefore needs to be defined separately:

```
Declare Function viRead32 Lib "Visa32" Alias "viRead" (ByVal vi As Long, Values As Any, ByVal count As Long, retCount As Long) As Long
```



The arrays for the measured data are dimensioned in such a way that they provide sufficient space for trace data of the R&S FSP (501 measurement points).

The arrays for the measured data are dimensioned in such a way that they provide sufficient space for trace data of the R&S FSP (625 measurement points).

```
REM *****
Public Sub ReadTrace()
Dim status As ViStatus
Dim retCnt As Long
REM ----- Creating variables -----
Dim traceData(1250) As Single      'Buffer for floating point binary data
Dim digits As Byte                 'Number of characters in length specification
Dim traceBytes As Integer          'Len. of trace data in bytes
Dim traceValues As Integer         'No. of meas. values in buff.
asciiResult$ = Space$(25000)      'Buffer for ASCII trace data
result$ = Space$(100)             'Buffer for simple results
startFreq$ = Space$(100)         'Buffer for start frequency
span$ = Space$(100)              'Buffer for span
REM ----- Default setting of the R&S FSP -----
Call SetupInstrument                'Default setting
status = viWrite(analyzer, "INIT:CONT OFF", 13, retCnt) 'Switch to single sweep
status = viWrite(analyzer, "INIT;*WAI", 9, retCnt)      'Perform sweep with sync
REM ----- Defining the frequency range for output -----
status = viWrite(analyzer, "FREQ:START?", 11, retCnt)   'Read start frequency
status = viRead(analyzer, startFreq$, 100, retCnt)
startFreq = Val(startFreq$)
status = viWrite(analyzer, "FREQ:SPAN?", 10, retCnt)    'Read span
status = viRead(analyzer, span$, 100, retCnt)
span = Val(span$)
REM ----- Reading out in binary format -----
status = viWrite(analyzer, "FORMAT REAL,32", 14, retCnt)
                                'Set binary format
status = viWrite(analyzer, "TRAC1? TRACE1", 13, retCnt)
                                'Read trace 1
```

```

status = viRead(analyzer, result$, 2, retCnt)
                        'Read and store length spec. for number of
digits = Val(Mid$(result$, 2, 1))'characters
result$ = Space$(100)   'Reinitialize buffer
status = viRead(analyzer, result$, digits, retCnt)
                        'Read and store length specification

traceBytes = Val(Left$(result$, digits))
status = viRead32(analyzer, traceData(0), traceBytes, retCnt)
                        'Read trace data into buffer
status = viRead(analyzer, result$, 1, retCnt)
                        'Read in delimiter <NL>

REM ----- Outputting binary data as frequency/level pairs -----
traceValues = traceBytes / 4   'Single precision = 4 bytes
stepsize = span / traceValues  'Calculate frequency step size
For i = 0 To traceValues - 1
Print "Value["; i; "] = "; startFreq + stepsize * i; ", "; traceData(i)
Next i

REM ----- Default setting of the time domain -----
status = viWrite(analyzer, "FREQ:SPAN 0Hz", 13, retCnt) 'Switch to time domain
status = viWrite(analyzer, "INIT;*WAI", 9, retCnt)      'Perform sweep with sync

REM ----- Reading out in ASCII format -----
status = viWrite(analyzer, "FORMAT ASCII", 12, retCnt)  'Set ASCII format
status = viWrite(analyzer, "TRAC1? TRACE1", 13, retCnt) 'Read and output
status = viRead(analyzer, asciiResult$, 25000, retCnt)
Print "Contents of Tracel: ", asciiResult$ 'trace 1

END SUB
REM *****

```

7.2.4 Storing and Loading Instrument Settings

7.2.4.1 Storing Instrument Settings

In the following example, the settings/measured data to be stored are initially defined, in which case only the hardware settings are stored. However, the selection commands for the other settings are specified with the state "OFF" for the sake of completeness.

```

REM *****
Public Sub StoreSettings()
Dim status As ViStatus
Dim retCnt As Long
'This subroutine selects the settings to be stored and creates the
'data record "TEST1" in the directory D:\USER\DATA. It uses the default
'setting and resets the instrument after the setting is stored.
REM ----- Default settings of the R&S FSP -----
Call SetupInstrument
status = viWrite(analyzer, "INIT:CONT OFF", 13, retCnt) 'Change to single sweep
status = viWrite(analyzer, "INIT;*WAI", 9, retCnt)      'Perform sweep with sync
REM ----- Selection of settings to be stored -----

```

Detailed Programming Examples

```

status = viWrite(analyzer, "MMEM:SEL:HWS ON", 15, retCnt)
                        'Store hardware settings
status = viWrite(analyzer, "MMEM:SEL:TRAC OFF", 17, retCnt)
                        'Do not store any traces
status = viWrite(analyzer, "MMEM:SEL:LIN:ALL OFF", 20, retCnt)
                        'Store only the activated limit lines

REM ----- Entering comments -----
status = viWrite(analyzer, "MMEM:COMM 'Test Setup'", 22, retCnt)
REM ----- Storing on the instrument -----
status = viWrite(analyzer, "MMEM:STOR:STAT 1,'D:\USER\DATA\TEST1'", 37, retCnt)
REM ----- Resetting the instrument -----
status = viWrite(analyzer, "*RST", 4, retCnt)

END SUB
REM *****

```

7.2.4.2 Loading Instrument Settings

In the following example, the *TEST1* data record stored under *D:\USER\DATA* is reloaded into the instrument:

```

REM *****
Public Sub LoadSettings()

Dim status As ViStatus
Dim retCnt As Long
'This subroutine loads the TEST1 data record in the directory D:\USER\DATA.
REM ----- Default setting of the status register -----
Call SetupStatusReg                'Configure status register
'----- Loading the data record -----
status = viWrite(analyzer, "MMEM:LOAD:STAT 1,'D:\USER\DATA\TEST1'", 37, retCnt)
REM ----- Performing measurement using loaded data record -----
status = viWrite(analyzer, "DISP:TRAC1:MODE WRITE", 21, retCnt)
                        'Set trace to Clr/Write
status = viWrite(analyzer, "INIT;*WAI", 9, retCnt)
                        'Start sweep

END SUB
REM *****

```

7.2.4.3 Setting the Data Record for Startup Recall

In the following example, the first step is to change the R&S FSP to the default state. In the next step, the *TEST1* data record stored under *D:\USER\DATA* is selected for the STARTUP RECALL function, i.e. the data record is then set after each *RST, PRESET and each time the instrument is started. For demonstration purposes, the command *RST is carried out again.

```

REM *****
Public Sub StartupRecallSettings()
Dim status As ViStatus
Dim retCnt As Long
REM ----- Resetting the R&S FSP -----
status = viWrite(analyzer, "*RST", 4, retCnt)
REM ----- Default setting of the status register -----
Call SetupStatusReg           'Configure status register
REM ----- Selecting the startup recall data record -----
status = viWrite(analyzer, "MMEM:LOAD:AUTO 1,'D:\USER\DATA\TEST1'", 37, retCnt)
REM ----- Activating the startup recall data record -----
status = viWrite(analyzer, "*RST", 4, retCnt)
END SUB
REM *****

```

7.2.5 Configuring and Starting a Printout

The following example shows how to configure the output format and output device for printing out a measurement screen.

The procedure is as follows:

1. Set the measurement you want for the printout.
2. Check which output devices are available on the instrument.
3. Select an output device.
4. Select the output interface.
5. Configure the output format.
6. Start the printout with synchronization to the end.

It is assumed that the desired setting is a signal at 100 MHz with a power of –20 dBm. It is also assumed that the sixth printer out of the available printers that are listed is the one you want. The printout is first output to the selected printer and then to a file.

```

REM *****
Public Sub HCopy()
Dim status As ViStatus
Dim retCnt As Long
Dim Devices(100) As String           'Create buffer for printer name
For i = 0 To 49
    Devices$(i) = Space$(50)         'Preallocate buffer for printer name
Next i

```

Detailed Programming Examples

```

REM ----- Default setting of the R&S FSP -----
Call SetupStatusReg                                'Configure status register
status = viWrite(analyzer, "*RST", 4, retCnt)      'Reset instrument
status = viWrite(analyzer, "INIT:CONT OFF", 13, retCnt) 'Single sweep mode
status = viWrite(analyzer, "SYST:DISP:UPD ON", 16, retCnt)
                                                    'Screen display on

REM ----- Measurement settings -----
status = viWrite(analyzer, "FREQ:CENT 100MHz;SPAN 10MHz", 27, retCnt)
                                                    'Frequency setting
status = viWrite(analyzer, "DISP:WIND:TRAC:Y:RLEV -10dBm", 28, retCnt)
                                                    'Reference Level
status = viWrite(analyzer, "INIT;*WAI", 10, retCnt) 'Perform measurement

REM ----- Querying the available output devices -----
status = viWrite(analyzer, "SYST:COMM:PRIN:ENUM:FIRST?", 26, retCnt)
                                                    'Read out and display first output device
status = viRead(analyzer, Devices$(0), 100, retCnt)
Print "Printer 0: " + Devices$(0)
For i = 1 To 99
    status = viWrite(analyzer, "SYST:COMM:PRIN:ENUM:NEXT?", 24, retCnt)
                                                    'Read out next printer name
    status = viRead(analyzer, Devices$(i), 100, retCnt)
    If Left$(Devices$(i), 2) = "" Then GoTo SelectDevice
                                                    'Stop at end of list
    Print "Printer" + Str$(i) + ": "; Devices$(i)
                                                    'Display printer name
Next i
SelectDevice:

REM - Selection of output device, printer language and output interface ----
status = viWrite(analyzer, "SYST:COMM:PRIN:SEL " + Devices(6), 19 + Len(Devices(6)),
retCnt)
                                                    'Printer selection #6
status = viWrite(analyzer, "HCOP:DEST 'SYST:COMM:PRIN'", 26, retCnt)
                                                    'Configuration: "Printout to printer interface"
status = viWrite(analyzer, "HCOP:DEV:LANG GDI", 17, retCnt)
                                                    'Printers require printer language 'GDI'

REM -- Selection of orientation (portrait/landscape) and color/BW -----
status = viWrite(analyzer, "HCOP:PAGE:ORI PORTRait", 22, retCnt)
                                                    'Portrait orientation
status = viWrite(analyzer, "HCOP:DEV:COL OFF", 16, retCnt)
                                                    'Black-and-white printout

REM -- Configuring and starting the printout -----
status = viWrite(analyzer, "HCOP:ITEM:ALL", 13, retCnt)
                                                    'All screen contents
'status = viWrite(analyzer, "HCOP:ITEM:WIND1:TRACE:STAT ON", 29, retCnt)
'status = viWrite(analyzer, "HCOP:ITEM:WIND2:TRACE:STAT ON", 29, retCnt)
                                                    'Alternative: only traces in screen A/B
status = viWrite(analyzer, "*CLS", 4, retCnt)
                                                    'Reset status administration

```

Detailed Programming Examples

```
status = viWrite(analyzer, "HCOP:IMMediate;*OPC?", 19, retCnt)
                        'Start printout
status = viRead(analyzer, result$, 100, retCnt)
REM - Printout in WMF format (BMP format) to file -----
status = viWrite(analyzer, "HCOP:DEST 'MMEM'", 16, retCnt)
                        'Configuration: "Printout to file"
status = viWrite(analyzer, "HCOP:DEV:LANG WMF", 17, retCnt)
                        'WMF file format
'status = viWrite(analyzer, "HCOP:DEV:LANG BMP", 17, retCnt)
                        'BMP file format
status = viWrite(analyzer, "MMEM:NAME 'D:\USER\DATA\PRINT1.WMF'", 35, retCnt)
                        'Define file name
status = viWrite(analyzer, "*CLS", 4, retCnt)
                        'Reset Status administration
status = viWrite(analyzer, "HCOP:IMMediate;*OPC?", 19, retCnt)
                        'Start printout
status = viRead(analyzer, result$, 100, retCnt)
END SUB
REM *****
```

Appendix

Appendix A: Printer Interface

This appendix describes the installation procedure for local printers. You can either use a plug&play printer (e.g. via USB) or a non-plug&play printer (e.g. via the LPT port).



To install printer drivers that are not preinstalled on the instrument, you can use one of the following external devices: LAN, USB device (e.g. memory stick or CD-ROM).

You can install a local printer via manual or remote control. In the following step-by-step instructions, the installation process is described via remote desktop. Alternatively, you can connect a mouse and keyboard for the installation instead of using the front panel. Also read the documentation of your printer on how to install the printer.

After installation, the instrument must be configured for printing with a printer. Refer to [“Selecting and Configuring Printers”](#) for more information on how to select and configure printers directly on the instrument.

A detailed description for installing network printers is provided in chapter [“Installing a Network Printer”](#).

A.1 Installing USB Printers

- If you use a USB device for driver installation, install the USB device on the instrument and connect it to the instrument before starting the installation.
- If you use a LAN connection for driver installation, the corresponding network drives must be mounted before starting the installation.
- Connect the printer via the USB connector on the front panel to the R&S FSP. The first page of the *Found New Hardware Wizard* dialog box is displayed.



- Select the *No, not this time* option to skip the Windows update via internet.

You can also perform a Windows update by selecting one of the other options. However, note that the R&S FSP

- has limited disk space, so make sure that there's enough disk space available or save the update on an external medium, e.g. a USB stick.
- has to be connected to the internet to perform an update.

Installing USB Printers

➤ Click *Next* to get to the second *Found New Hardware Wizard* dialog box.



➤ Select the *Install the software automatically* option.

The installation process runs automatically and a dialog box is displayed after the installation is completed. Proceed with step 15.

If the driver software cannot be found, an error message is displayed.



Installing USB Printers

- Deactivate the *Don't prompt me again* to install this software option.
- Click *Finish*.

The first page of the wizard is displayed again.

- Select the *Install from a list or specific location* option.
- Click *Next*.

The third page of the wizard is displayed.

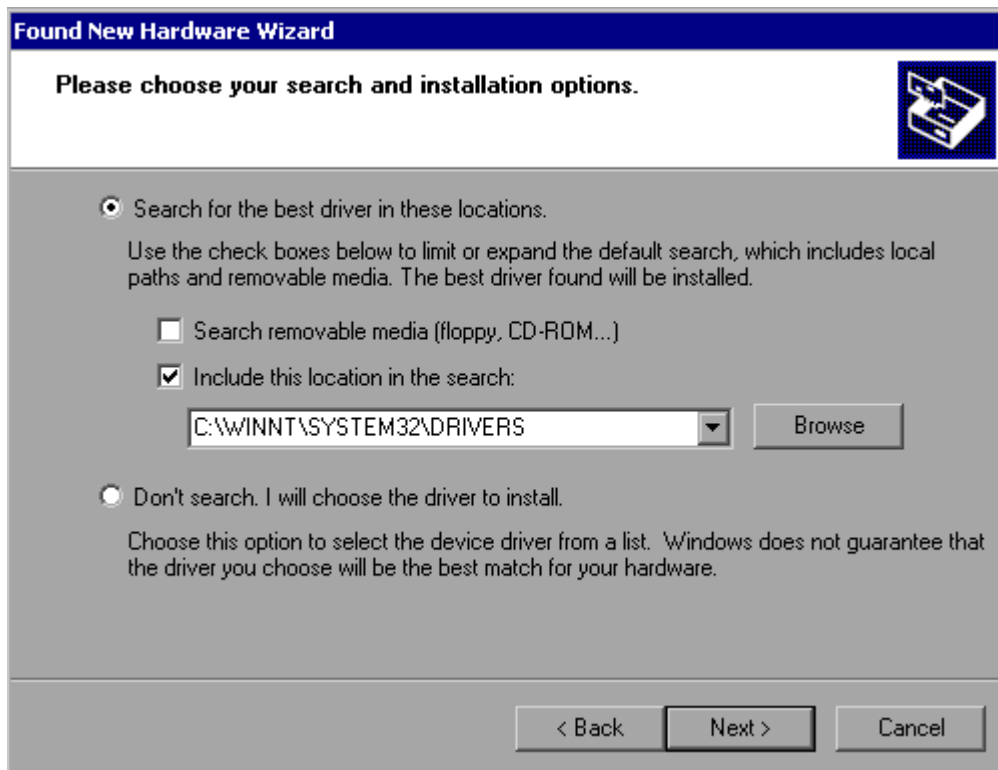

- Connect the USB device containing the driver to the R&S FSP (e.g. the CD-ROM drive or a memory stick)
- Activate the *Include this location* in the search option.
- Click the *Browse* button.

The dialog box to browse for a folder is displayed.
- On the USB device, select the folder containing the printer drivers.
- Click *OK*. This button is only active, if the selected folder contains drivers.

The third page of the wizard is displayed again.

Installing USB Printers

➤ Click *Next*.

The selected folder is searched for the printer driver and the printer driver files are copied to C:. After the installation is finished, a dialog box is displayed.

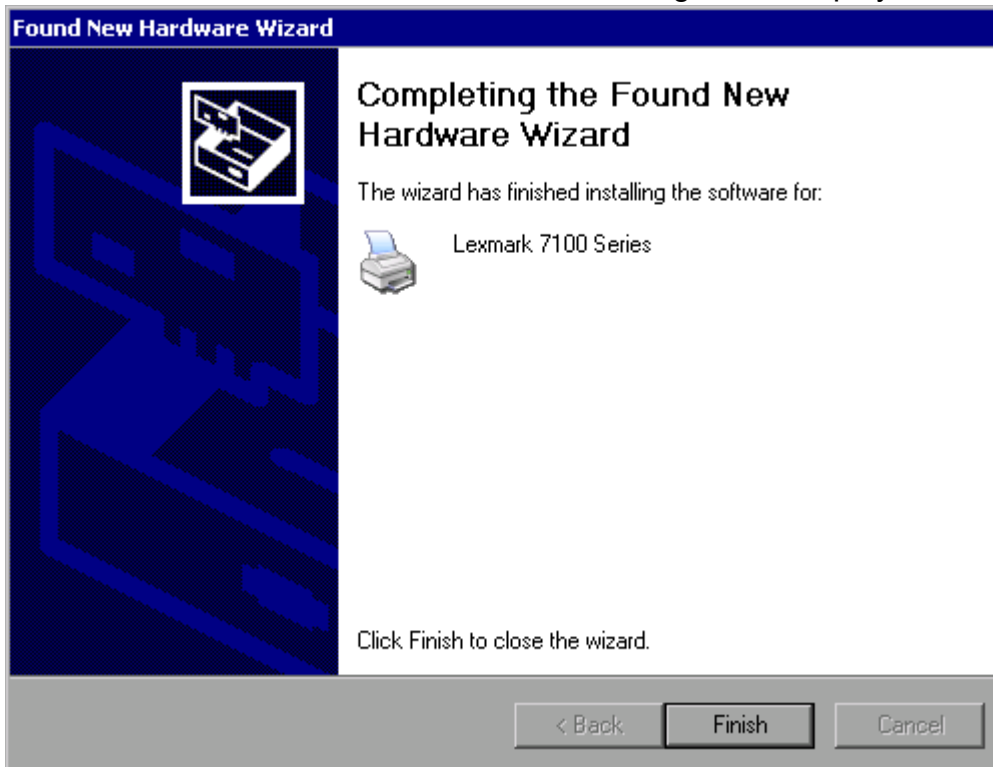

Installing Non-Plug&Play Printers

A.2 Installing Non-Plug&Play Printers



The following dialog boxes can be operated either from the front panel or via a mouse and keyboard (see sections “[Connecting a Mouse](#)” and “[Connecting an External Keyboard](#)” on page 2.9).

A new printer is installed using *HCOPIY - NEXT - INSTALL PRINTER*.

A.2.1 Local Printer

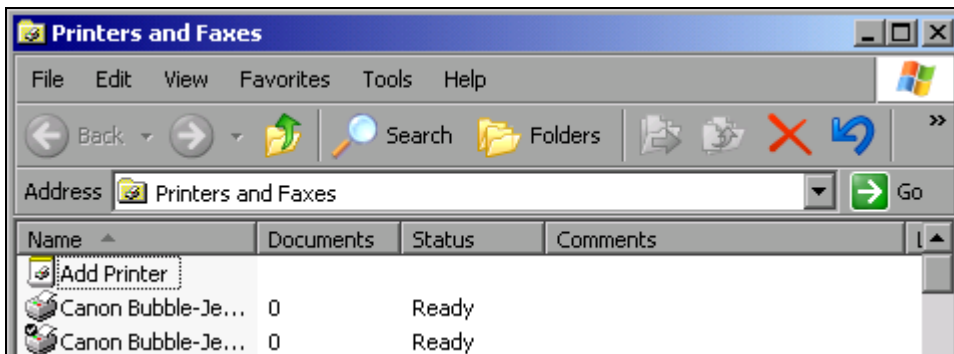

- Using the rotary knob, select *Add Printer* from the list.
- Mark the selected item with the right arrow key, and press *ENTER* or the rotary knob to confirm the selection.
The *Add Printer Wizard* will appear.

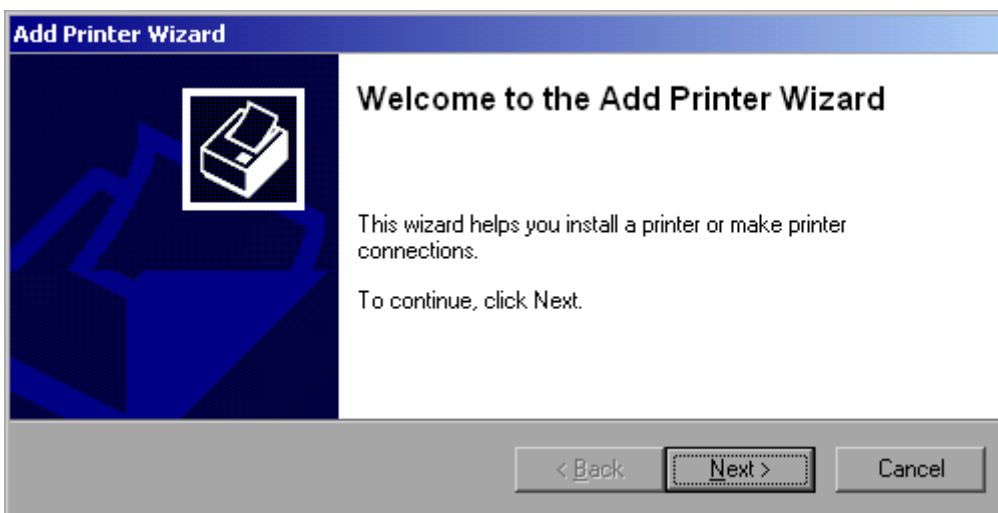

- Using the rotary knob, select *NEXT* and confirm by pressing the rotary knob.

Installing Non-Plug&Play Printers

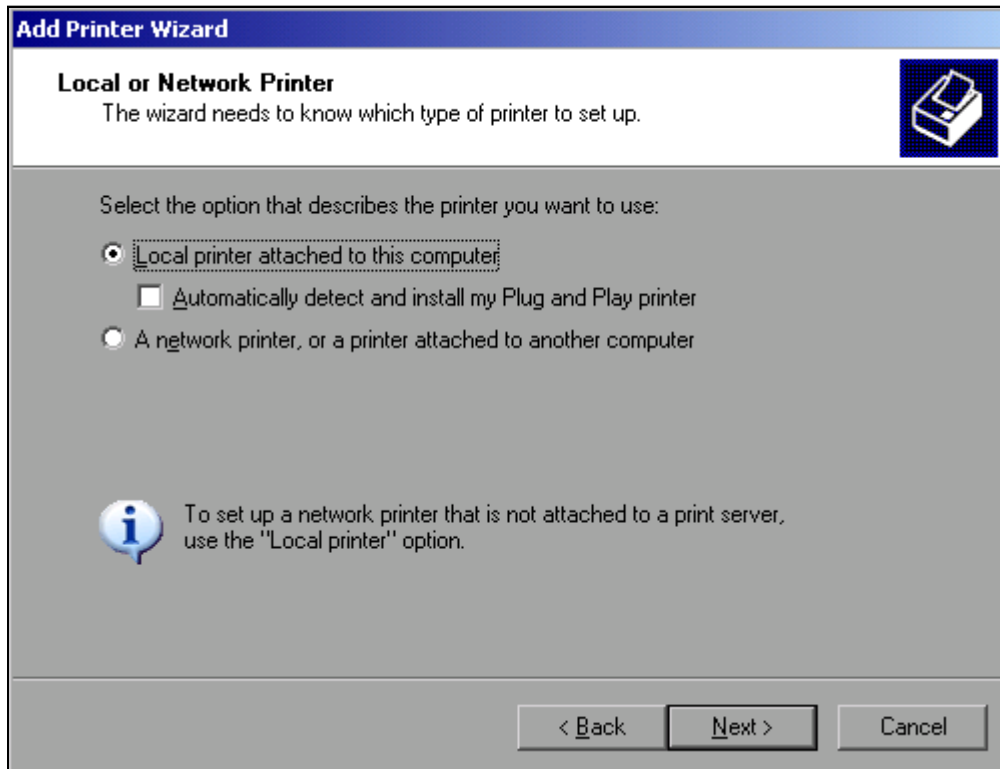

- To install a local printer, select *Local printer attached to this computer* with the rotary knob, confirm by pressing the rotary knob and continue to the next step.
- To install a network printer, select *A network printer, or a printer attached to another computer*, confirm by pressing the rotary knob and continue to the next step.

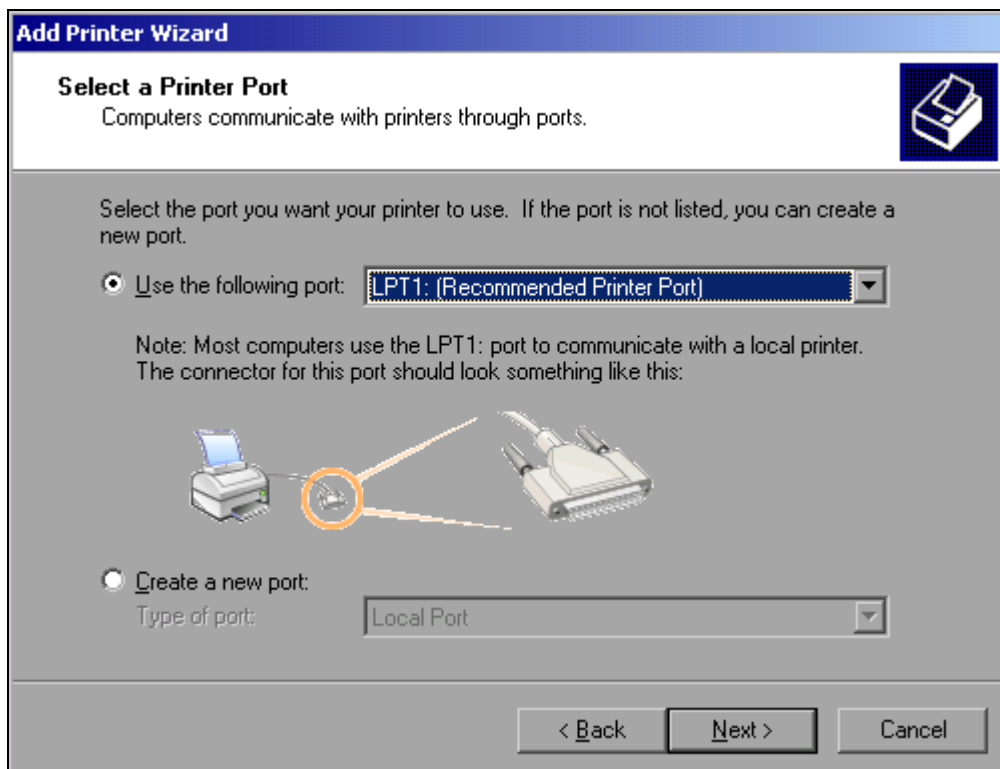

Installing Non-Plug&Play Printers

In the following example, a local printer of type Star LC24 is installed.

- To select a USB connection, open the list of available ports by pressing the rotary knob. Using the arrow keys or rotary knob, select a printer port and confirm by pressing the rotary knob.
- To select an LPT connection, you do need not to open the selection list.
- Using the rotary knob, move the focus to the *Next* button and confirm by pressing the rotary knob.

The *Install Printer Software* dialog panel will open.

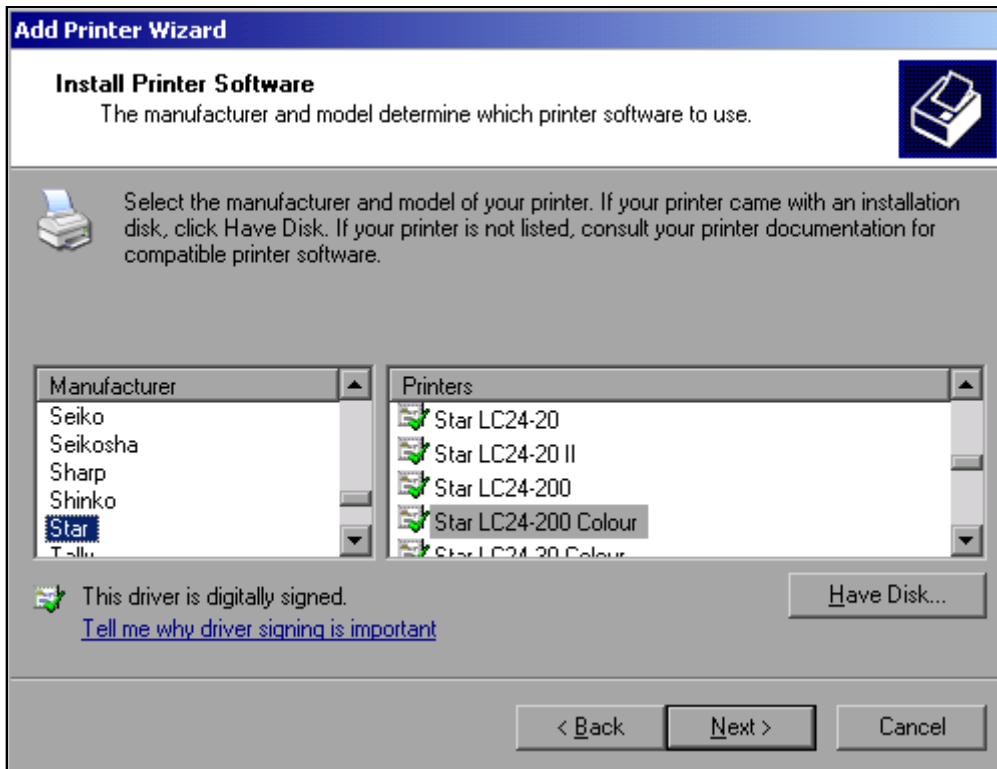

- Using the arrow up/down keys, select the required manufacturer (*Star*) from the *Manufacturers* table.
- Using the rotary move, go to the *Printers* table.
- Using the arrow up/down keys, select the desired printer type (*Star LC24-200 Colour*) and confirm with *ENTER*.



If the desired printer type is not in the list, its driver has not yet been installed. In this case, click the *Have Disk* button with the mouse. You will be prompted to insert a disk containing the corresponding printer driver. Press OK and select the desired printer driver.

Installing Non-Plug&Play Printers

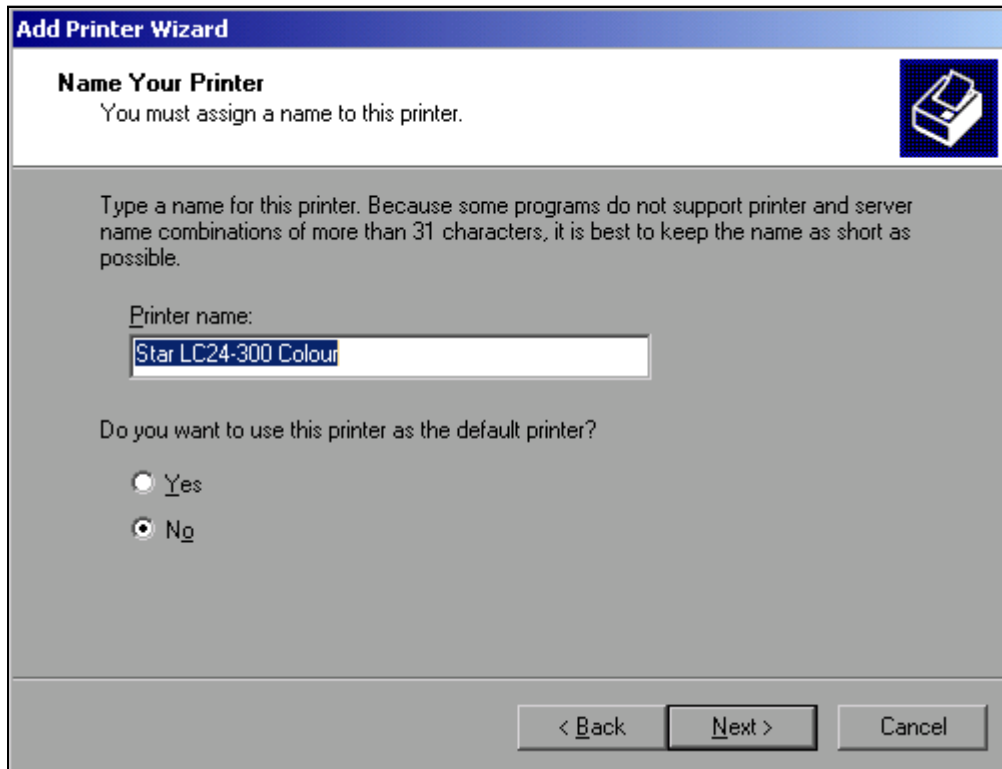

- You can change the printer name in the *Printer Name* field to any name you want (max. 60 characters). However, this requires using a PC keyboard.
- Using the rotary knob, select *Default Printer yes / no*.
- Using the arrow up/down keys, select the desired status.
- Confirm the entry with *ENTER*.
The *Printer Sharing* dialog panel will open.
- Confirm the entry with *ENTER*.
The *Printer Sharing* dialog panel will open.
- Exit the dialog panel by pressing *ENTER*.
The *Completing the Add Printer Wizard* dialog panel will open.

Installing Non-Plug&Play Printers

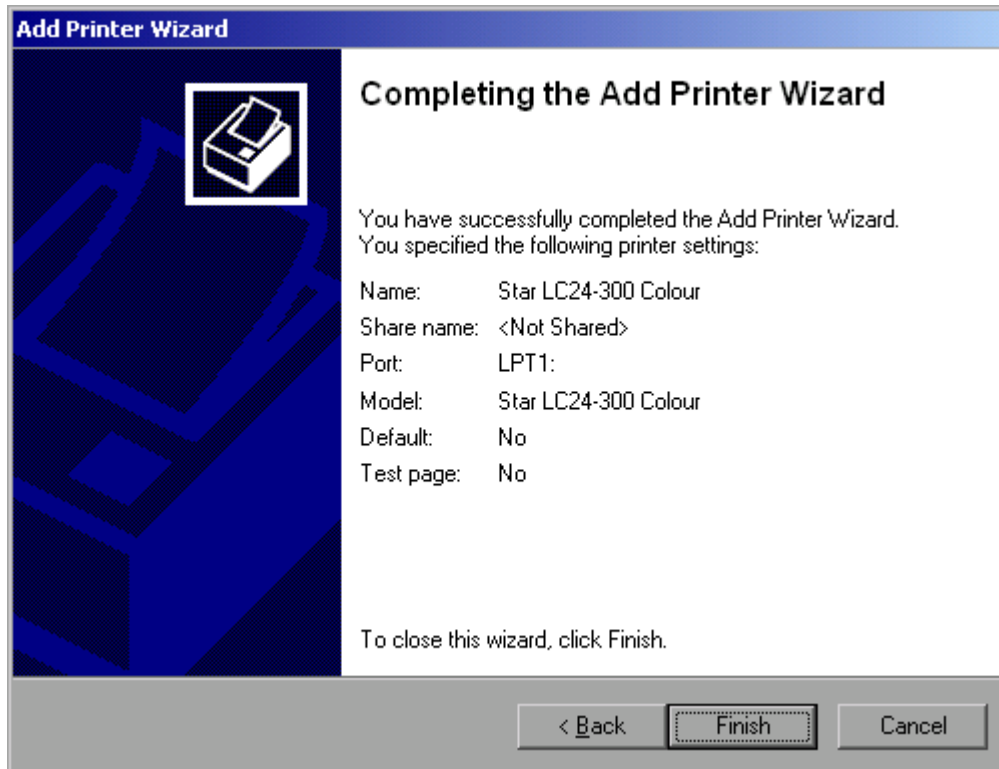

- Check the displayed settings and exit the dialog panel with *ENTER*. The printer will be installed. If Windows finds the required driver files, the installation will be completed without any further queries.

If Windows cannot find the required driver files, the dialog box for entering the path for files will open.

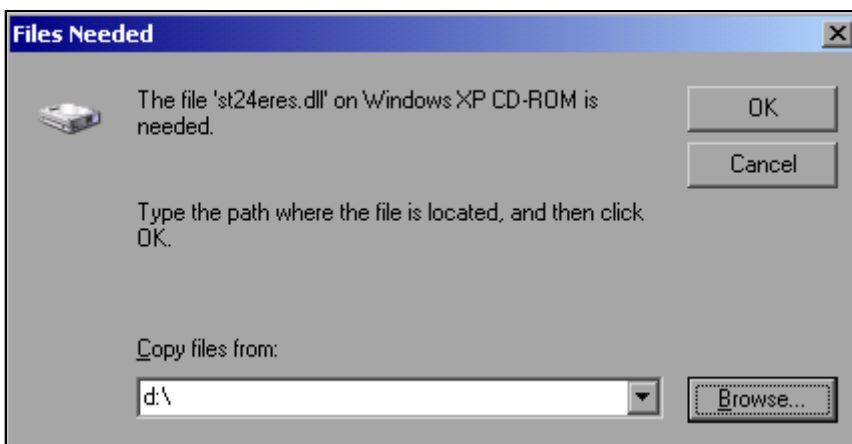

- Using the rotary knob, select the *Browse* button and confirm by pressing the rotary knob. The *Locate File* dialog box will open.

Installing Non-Plug&Play Printers

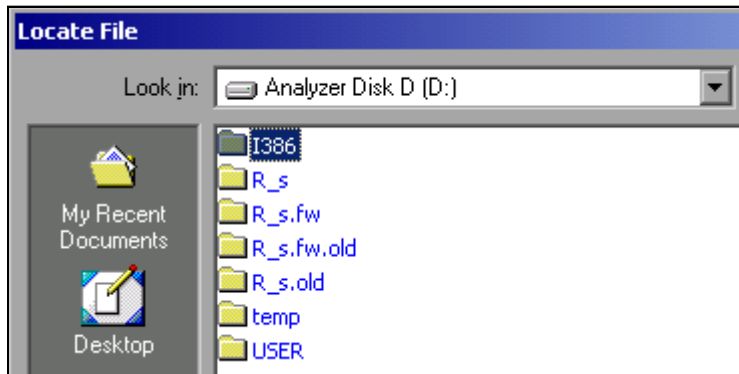

- Select the path D:\I386 by turning the rotary knob and then pressing it. If the background of the selection bar is not blue, the selection must be marked with the arrow up/down keys before the entry can be selected by pressing the rotary knob.

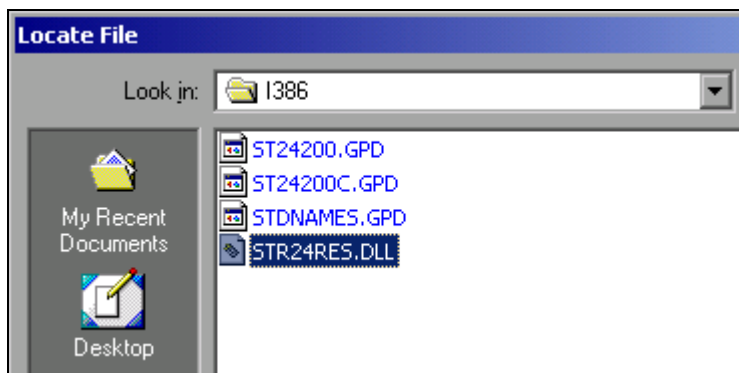

- Using the rotary knob, select a driver file and confirm by pressing the rotary knob. The file will be added to the *Files Needed* dialog box.



If the file is not available in the D:\I386 directory, you will need a disk containing the driver file. In this case, exit the dialog box with ESC and repeat the selection starting with the *Files needed* dialog box.

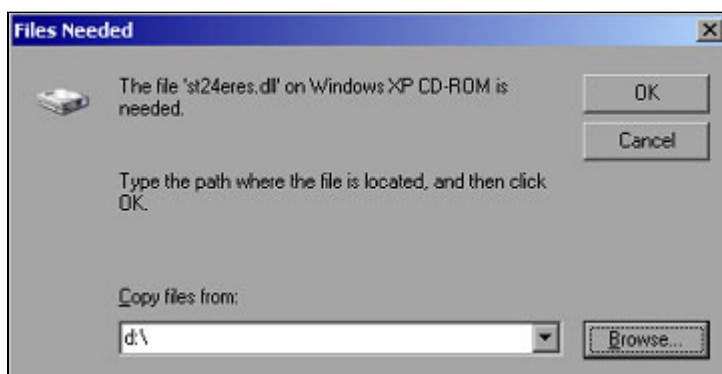

- Using the rotary knob, select *OK* and confirm by pressing the rotary knob. The installation will be completed.

Installing Non-Plug&Play Printers

The instrument must then be configured for printout with this printer using the DEVICE SETUP and DEVICE 1/2 softkeys in the hardcopy main menu (see section “ [Selecting and Configuring Printers](#)” on page 2.27).

A.2.2 Network Printer

Network printer installation is described in chapter 6, section “ [Installing a Network Printer](#)” on page 6.17.

List of Generator Types Supported by the R&S FSP

Appendix B: External Generator Control

B.1 List of Generator Types Supported by the R&S FSP

Generator	Interface Type	Generator Min. Freq.	Generator Max. Freq.	Generator Min. Power dBm	Generator Max. Power dBm
SME02	TTL	5 kHz	1.5 GHz	-144	+16
SME03	TTL	5 kHz	3.0 GHz	-144	+16
SME06	TTL	5 kHz	6.0 GHz	-144	+16
SMG	GPIB	100 kHz	1.0 GHz	-137	+13
SMGL	GPIB	9 kHz	1.0 GHz	-118	+30
SMGU	GPIB	100 kHz	2.16 GHz	-140	+13
SMH	GPIB	100 kHz	2.0 GHz	-140	+13
SMHU	GPIB	100 kHz	4.32 GHz	-140	+13
SMIQ02B	TTL	300 kHz	2.2 GHz	-144	+13
SMIQ02E	GPIB	300 kHz	2.2 GHz	-144	+13
SMIQ03B	TTL	300 kHz	3.3 GHz	-144	+13
SMIQ03E	GPIB	300 kHz	3.3 GHz	-144	+13
SMIQ04B	TTL	300 kHz	4.4 GHz	-144	+10
SMIQ06B	TTL	300 kHz	6.4 GHz	-144	+10
SML01	GPIB	9 kHz	1.1 GHz	-140	+13
SML02	GPIB	9 kHz	2.2 GHz	-140	+13
SML03	GPIB	9 kHz	3.3 GHz	-140	+13
SMR20	TTL	1 GHz	20 GHz	-130 ²⁾	+11 ²⁾
SMR20B11 ¹⁾	TTL	10 MHz	20 GHz	-130 ²⁾	+13 ²⁾
SMR27	TTL	1 GHz	27 GHz	-130 ²⁾	+11 ²⁾
SMR27B11 ¹⁾	TTL	10 MHz	27 GHz	-130 ²⁾	+12 ²⁾
SMR30	TTL	1 GHz	30 GHz	-130 ²⁾	+11 ²⁾
SMR30B11 ¹⁾	TTL	10 MHz	30 GHz	-130 ²⁾	+12 ²⁾
SMR40	TTL	1 GHz	40 GHz	-130 ²⁾	+9 ²⁾
SMR40B11 ¹⁾	TTL	10 MHz	40 GHz	-130 ²⁾	+12 ²⁾
SMR50	TTL	1 GHz	50 GHz	-130 ²⁾	+9 ²⁾
SMR50B11 ¹⁾	TTL	10 MHz	50 GHz	-130 ²⁾	+12 ²⁾
SMR60	TTL	1 GHz	60 GHz	-130 ²⁾	+9 ²⁾

List of Generator Types Supported by the R&S FSP

Generator	Interface Type	Generator Min. Freq.	Generator Max. Freq.	Generator Min. Power dBm	Generator Max. Power dBm
SMR60B11 ¹⁾	TTL	10 MHz	60 GHz	-130 ²⁾	+12 ²⁾
SMP02	TTL	10 MHz	20 GHz	-130 ³⁾	+17 ³⁾
SMP03	TTL	10 MHz	27 GHz	-130 ³⁾	+13 ³⁾
SMP04	TTL	10 MHz	40 GHz	-130 ³⁾	+12 ³⁾
SMP22	TTL	10 MHz	20 GHz	-130 ³⁾	+20 ³⁾
SMT02	GPIB	5.0 kHz	1.5 GHz	-144	+13
SMT03	GPIB	5.0 kHz	3.0 GHz	-144	+13
SMT06	GPIB	5.0 kHz	6.0 GHz	-144	+13
SMU200A	TTL	100 kHz	6.0 GHz	-145	+19
SMV03	GPIB	9 kHz	3.3 GHz	-140	+13
SMX	GPIB	100 kHz	1.0 GHz	-137	+13
SMY01	GPIB	9 kHz	1.04 GHz	-140	+13
SMY02	GPIB	9 kHz	2.08 GHz	-140	+13
HP8340A	GPIB	10 MHz	26.5 GHz	-110	+10
HP8648	GPIB	9 kHz	4 GHz	-136	+10
HP ESG-A Series 1000A, 2000A, 3000A, 4000A	GPIB	250 kHz	4 GHz	-136	+20
HP ESG-D SERIES E4432B	GPIB	250 kHz	3 GHz	-136	+10

1) Requires installation of the option R&S SMR-B11.

2) Maximum/minimum power depends on the presence of the option R&S SMR-B15/-B17 and on the frequency range that has been set.

For more information, refer to the R&S SMR data sheet.

3) Maximum/minimum power depends on the presence of the option R&S SMP-B15/-B17 and on the frequency range that has been set.

For more information, refer to the R&S SMP data sheet.

Index

Symbols

* (enhancement label) 4.6

Numerics

20.4 MHz OUT 1.15
75 Ohm (enhancement label) 4.6

A

A/B (enhancement label) 4.6
AC power supply 1.12
 connecting 2.6
administrator ID 2.35, 2.39
advanced measurement examples 5.35
AF OUTPUT 1.7
AM-modulated signals
 measuring 5.26
AMPT key 1.4
AP (detector) 4.5
approved software 2.40
arrow keys 4.8
Att (hardware setting) 4.3
automatic login mechanism
 activating 6.14
 deactivating 6.14
AUX CONTROL 1.17, 2.15
AV (detector) 4.5
AVG (trace mode) 4.5

B

BACK key 4.7
basic measurement examples 5.2
booting
 loading data record 5.33
booting the instrument 2.6
brightness (screen) 2.23
burst signal
 measuring signal-to-noise ratio 5.23
BW key 1.4

C

CAL key 1.5, 2.6
CCVS IN/OUT 1.16
CF CARD 1.9
cleaning the outside 2.8
CLRWR (trace mode) 4.5
color printout 2.28
color saturation (screen) 2.24
colors (screen) 2.24
COM 1.12
configuration
 different networks 6.6
 instrument 5.31, 5.32, 5.33
 network 6.6
 Windows XP Firewall 6.8
connector
 20.4 MHz OUT 1.15
 AC power supply 1.12
 AF OUTPUT 1.7
 AUX CONTROL 1.17, 2.15
 CCVS IN/OUT 1.16
 CF CARD 1.9
 COM 1.12
 disk drive 1.8
 EXT MIXER 1.6
 EXT TRIG/GATE IN 1.13
 front panel 1.6
 GEN OUTPUT 50 Ohm 1.6
 GPIB interface 1.12
 GPIB interface 2 1.16
 KEYBOARD 1.8, 2.9
 LAN 1.16
 LPT 1.12, 2.13
 MONITOR 1.13, 2.12
 MOUSE 2.11
 NOISE SOURCE 1.13
 PROBE POWER 1.7
 rear panel 1.12
 REF IN 1.15
 REF OUT 1.15
 RF INPUT 1.6
 TG I/AM IN 1.16
 TG I/FM IN 1.16
 TRIGGER PORT 1.14
 USB 1.14

- cursor 4.8
- ## D
- date
 entering 2.20
- directory sharing 6.21
- disk drive 1.8
- DISP key 1.5, 2.23, 2.24
- documentation overview 1.1
 Operating Manual 1.2
 Quick Start Guide 1.1
 Service Manual 1.2
- ## E
- EATT (hardware setting) 4.3
- editor
 alphanumeric type 1 4.9
 alphanumeric type 2 4.10
- enhancement label 4.6
 * 4.6
 75 Ohm 4.6
 A/B 4.6
 EXT 4.6
 FRQ 4.6
 GAT 4.6
 LVL 4.6
 PA 4.6
 PRN 4.6
 PS 4.6
 SGL 4.6
 TDF 4.6
 TRG 4.6
- entry
 cancel 4.7
 conclude 4.7, 4.8
- environmental conditions 2.4
- ESC/CANCEL key 4.7
- EXREF (status display) 4.4
- EXT (enhancement label) 4.6
- EXT MIXER 1.6
- EXT TRIG/GATE IN 1.13
- external generator
 activating configuration 2.17
 configuring 2.16
 connecting 2.15, 2.16
 setting output level 2.17
 supported types B.1
 using as tracking generator 2.18
- external keyboard 2.9
- ## F
- FILE key 1.5
- firmware
 installed options 3.3
 installing options 3.3
 uninstalling options 3.3
 update 3.2
- FM-modulated signals
 measuring 5.28
- FREQ key 1.4
- frequency reference 2.19
- front panel 1.2
 connectors 1.6
 function keys 1.4
- FRQ (enhancement label) 4.6
- function keys 1.4
- functional test 2.6
- ## G
- GAT (enhancement label) 4.6
- GEN OUTPUT 50 Ohm 1.6
- generator
 external 2.15
- generator control
 external 1.17, B.1
- GPIO address 2.20
- GPIO interface 1.12, 1.16
- GPIO language 2.21
- ## H
- Hardcopy Setup dialog box 2.27
- hardware setting display
 Att 4.3
 EATT 4.3
 LIMIT CHECK 4.3
 Marker/Delta 4.3
 Offset 4.3
 RBW 4.3
 Ref 4.3
 SWT 4.3
 VBW 4.3

- harmonics of sinusoidal signals*
 measuring 5.8
 HCOPI key 1.5, 2.27
 hotkey
 NETWORK..... 2.16
- I**
- ID response string 2.22
 IFOVL (status display) 4.4
 installation in a 19" rack..... 2.5
 instrument configuration
 automatic loading..... 5.33
 loading..... 5.32
 storing 5.31
 IP address
 predefined 2.33
- K**
- key
- AMPT 1.4
 BW 1.4
 CAL 1.5, 2.6
 DISP..... 1.5, 2.23, 2.24
 FILE..... 1.5
 FREQ 1.4
 HCOPI 1.5, 2.27
 LINES..... 1.5
 MEAS..... 1.5
 MKR 1.4
 MKR FCTN..... 1.4
 MKR->..... 1.4
 ON/STANDBY..... 1.4, 2.6
 PRESET..... 1.4
 SETUP 1.5, 2.7, 3.2, 6.3
 SPAN 1.4
 SWEEP 1.4
 TRACE..... 1.5
 TRIG..... 1.5
 KEYBOARD..... 1.8, 2.9
 keyboard
 connecting..... 2.9
 keypad 4.7
 BACK key..... 4.7
 conclude entry..... 4.7, 4.8
 ESC/CANCEL key..... 4.7
 numeric keys..... 4.7
 sign key..... 4.7
 unit keys..... 4.7
 keys..... 1.4
- L**
- LAN 1.16
 LAN interface 6.1
 configuring 2.30
 LIMIT CHECK (hardware setting) 4.3
 LINES key 1.5
 login
 automatic login mechanism 6.14
 network 6.14
 Windows XP 2.35
 LOUNL (status display) 4.4
 LPT..... 1.12, 2.13
 LVL (enhancement label) 4.6
- M**
- main power switch..... 1.12, 2.6
 manual operation
 XP Remote Desktop 6.24
 Marker/Delta (hardware setting)..... 4.3
 MAXH (trace mode) 4.5
 MEAS key 1.5
 measurement data
 loading 5.31
 storing 5.31
 measurement example
 advanced examples..... 5.35
 AM-modulated signals 5.26
 basic 5.2
 edges of GSM burst..... 5.20
 FM-modulated signals 5.28
 modulation depth of AM-modulated
 carrier..... 5.16
 power of GSM burst..... 5.18
 separating signals..... 5.11
 signal-to-noise ratio of GSM signal.. 5.23
 sinusoidal signal 5.3
 suppressing 2. and 3. harmonic..... 5.8
 measurement results
 printing 5.34
 memory stick
 connecting 2.14
 MI (detector)..... 4.5

- MINH (trace mode)4.5
- MKR FCTN key1.4
- MKR key1.4
- MKR-> key1.4
- modulation depth of AM-modulated carrier
 - measuring5.16
- MONITOR1.13, 2.12
- monitor
 - connecting2.12
- MOUSE2.11
- mouse
 - connecting2.11
 - supported devices2.11
- N**
- network
 - changing the user password6.11
 - configuration6.6
 - configuration changes6.6
 - connecting to2.30
 - creating users6.9
 - drives6.15
 - installing printer6.17, A.12
 - installing protocols, services6.3
 - login6.14
 - NOVELL6.13
 - sharing directories6.21
- network card
 - configuring2.30
- network card driver2.30
- network configuration2.31
- NETWORK hotkey2.16
- network protocol2.31
 - additional2.35
 - available2.33
- NOISE SOURCE1.13
- non-plug&play printer2.30
 - installingA.6
 - installing local printerA.6
 - installing network printerA.12
- NOVELL6.13
- numeric keys4.7
- O**
- Offset (hardware setting)4.3
- ON/STANDBY key1.4, 2.6
- operating system2.39
- operation
 - in a network6.9
 - without network6.9
- option
 - installed3.3
 - installing3.3
 - uninstalling3.3
- OVEN (status display)4.4
- OVLN (status display)4.4
- P**
- PA (enhancement label)4.6
- parameter
 - alphanumeric4.9
 - editing4.8, 4.9
 - numeric4.8
- password
 - Windows XP2.35
- pendrive
 - see memory stick
- PK (detector)4.5
- plug&play printer
 - installing2.29
- power meter
 - connecting2.13
- power of GSM burst
 - measuring5.18
- power save mode2.24
- power supply1.12
- predefined IP address2.33
- preparing for operation2.4
- PRESET key1.4
- printer
 - colors2.28
 - configuring2.27
 - connecting2.13
 - connector1.12, 2.13
 - localA.6
 - network printer6.17, A.12
 - non-plug&play2.30, A.6
 - output4.6
 - plug&play2.29
 - selecting2.27
- printout
 - color setting5.35
 - measurement results5.34

- printout colors* 2.28
- PRN (enhancement label)* 4.6
- PROBE POWER* 1.7
- protection against electrostatic discharge* ...
2.4
- protocol*
 - TCP/IP* 2.31
- PS (enhancement label)* 4.6

- Q**
- QP (detector)* 4.5

- R**
- RBW (hardware setting)* 4.3
- rear panel* 1.10
 - connectors* 1.12
- recall function* 2.6
- Ref (hardware setting)* 4.3
- REF IN* 1.15
- REF OUT* 1.15
- remote control*
 - introduction* 7.3
 - VISA interface* 7.3
- remote control example*
 - command synchronization* 7.8
 - configuring power save function* 7.6
 - controlling marker* 7.7
 - controlling screen display* 7.5
 - default measurement settings* 7.10
 - default settings* 7.9
 - fixed reference point* 7.14
 - frequency counting* 7.13
 - initializing the controller* 7.5
 - initializing the instrument* 7.5
 - loading instrument settings* 7.19
 - marker search functions* 7.12
 - measuring noise* 7.15
 - printout* 7.20
 - reading instrument settings* 7.7
 - setting status registers* 7.10
 - simple instrument settings* 7.6
 - startup recall* 7.20
 - storing instrument settings* 7.18
 - trace data* 7.16
- Remote Desktop*
 - see XP Remote Desktop*
- removable hard disk* 1.9
- RF INPUT* 1.6
- RM (detector)* 4.5
- rotary knob* 4.8
- RS-232-C interface* 1.12

- S**
- SA (detector)* 4.5
- screen*
 - automatically switching off* 2.24
 - brightness* 2.23
 - color saturation* 2.24
 - colors* 2.24
 - displays* 4.3
 - layout during analyzer operation* 4.2
 - tint* 2.23
- screen colors*
 - default setting* 2.23
- second GPIB interface* 1.16
- self alignment* 2.6
- self test* 2.6, 2.7
- service pack* 2.39
- setting up the instrument* 2.4
- SETUP key* 1.5, 2.7, 3.2, 6.3
- SGL (enhancement label)* 4.6
- sign key* 4.7
- signal spectra with multiple signals*
 - measuring* 5.11
- signal-to-noise ratio*
 - measuring* 5.23
- sinusoidal signal*
 - measuring* 5.3
 - measuring level and frequency* 5.3
 - measuring signal frequency* 5.6
- softkey*
 - BRIGHTNESS* 2.23
 - COLOR ON/OFF* 2.28
 - COLORS* 2.28
 - CONFIG DISPLAY* 2.23
 - CONFIGURE NETWORK* 2.31
 - DEFAULT COLORS* 2.23
 - DEVICE 1/2* 2.28
 - DEVICE SETUP* 2.27
 - DISPLAY PWR SAVE* 2.24
 - EXT SOURCE* 2.16
 - FIRMWARE UPDATE* 3.2
 - GENERAL SETUP* 2.19, 2.20, 6.3

- GPIB 2.20
 - GPIB ADDRESS 2.20
 - GPIB LANGUAGE 2.21
 - ID STRING FACTORY 2.22
 - ID STRING USER 2.22
 - INSTALL OPTION 3.3
 - OPTIMIZED COLORS 2.29
 - PREDEFINED COLORS 2.24
 - REFERENCE INT/EXT 2.19
 - REMOVE OPTION 3.3
 - RESTORE FIRMWARE 3.2
 - SATURATION 2.24
 - SCREEN COLORS 2.28
 - SELECT OBJECT 2.23
 - TIME+DATE 2.19
 - TINT 2.23
 - UPDATE PATH 3.2
 - USER DEFINED 2.29
 - SPAN key 1.4
 - standby mode 2.6, 2.7
 - Start menu (Windows XP) 2.40
 - status display 4.4
 - EXREF 4.4
 - IFOVL 4.4
 - LOUNL 4.4
 - OVEN 4.4
 - OVL 4.4
 - UNCAL 4.4
 - subnet mask 2.34
 - SWEEP key 1.4
 - switching off the instrument 2.7
 - switching on the instrument 2.6
 - SWT (hardware setting) 4.3
- T**
- TCP/IP network protocol 2.31
 - TCP/IP protocol
 - predefined IP address 2.33
 - subnet mask 2.34
 - TDF (enhancement label) 4.6
 - test setup
 - AM-modulated signals 5.26
 - FM-modulated carrier 5.28
 - measuring a sinusoidal signal 5.3
 - modulation depth of AM carrier 5.16
 - power of GSM burst 5.18
 - separating two signals 5.12
 - signal-to-noise ratio of GSM signal 5.23
 - TG I/AM IN 1.16
 - TG I/FM IN 1.16
 - time
 - entering 2.19
 - time domain measurements 5.17
 - tint (screen) 2.23
 - trace information 4.5
 - AP 4.5
 - AV 4.5
 - AVG 4.5
 - CLRWR 4.5
 - MAXH 4.5
 - MI 4.5
 - MINH 4.5
 - PK 4.5
 - QP 4.5
 - RM 4.5
 - SA 4.5
 - trace mathematics 4.5
 - VIEW 4.5
 - TRACE key 1.5
 - trace mathematics 4.5
 - traces
 - storing 5.32
 - tracking generator
 - modulation 1.16
 - output 1.6
 - transducer
 - connector 1.7
 - TRG (enhancement label) 4.6
 - TRIG key 1.5
 - trigger
 - connector 1.13
 - TRIGGER PORT 1.14
- U**
- UNCAL (status display) 4.4
 - unit keys 4.7
 - unpacking the instrument 2.4
 - USB 1.14
 - USB devices
 - connecting 2.13
- V**
- VBW (hardware setting) 4.3

<i>VIEW (trace mode)</i>	4.5
<i>VISA interface</i>	
<i>basic programming steps</i>	7.3
<i>creating global variables</i>	7.4
<i>initialization, default state</i>	7.4
<i>library for Visual Basic</i>	7.3

W

<i>Windows XP</i>	2.39
<i>administrator ID</i>	2.35, 2.39
<i>approved software</i>	2.40
<i>Firewall</i>	6.8
<i>login</i>	2.35
<i>password</i>	2.35
<i>service pack</i>	2.39
<i>Start menu</i>	2.40

X

<i>XP Remote Desktop</i>	6.24
<i>connection</i>	6.33
<i>connection setup</i>	6.30
<i>controller configuration</i>	6.27
<i>instrument configuration</i>	6.24
<i>instrument deactivation</i>	6.34